

corpuls **cpr**

 GS Elektromedizinische Geräte

G. Stemple GmbH

Hauswiesenstraße 26

86916 Kaufering

Germany



For a patient/user/third party in the European Union and in countries with identical regulatory regime; if, during the use of this device or as a result of its use, a serious incident has occurred, please report it to the manufacturer and/or its authorised representative and to your national authority.

Subject to technical modifications, mistakes and printing errors.

The rights to the trademarks and registered trademarks named remain with the originators and the holders of the respective trademark rights.

The use of this document for the following purposes is not permitted without the written consent of GS Elektromedizinische Geräte G. Stemple GmbH: Reproduction, storage, processing, duplication, translation and distribution.

Further technical information can be obtained from the manufacturer.

Service Address

For questions, please contact authorised sales and service partners:



Information on authorised sales and service partners can be found at:

www.corpuls.world

Versions of the User Manual

Issue	Date	Version of User Manual	Version of Software
1	05/2016	1.0	cCPR_1.0.x
2	02/2017	1.0 A	cCPR_1.0.x
3	03/2018	1.0 B	cCPR_1.0.x
4	3/2019	1.1 A	cCPR_1.1.x
5	7/2020	1.2 A	cCPR_1.2.x
6	02/2021	1.3 A	cCPR_1.3.x
7	06/2022	1.3 B	cCPR_1.3.x
8	01/2023	1.3 C	cCPR_1.3.x

Table of Contents

1	Evaluation Software	8
2	Performance Description	9
2.1	Intended Use	9
2.2	Appropriate Use	9
2.3	Essential Performances	9
2.4	Areas of Application	9
2.5	Indication	9
2.6	Contraindication	10
2.7	Intended Patient Group	10
2.8	Adverse Effects	10
3	Safety	11
3.1	Safety Instructions for the User	11
3.2	Cyber Security	12
3.3	Symbols	12
4	Directions for Users	17
4.1	Requirements for the User	17
4.2	Clinical Benefit	17
4.3	Training Concept	17
4.3.1	Target audience	17
4.3.2	Taking into Account Country-Specific Requirements	19
4.3.3	Initial Product Training	19
4.4	Use of this Manual	19
4.4.1	Typographic Conventions	19
4.4.2	Depiction of Warnings	20
4.4.3	Depiction of Notices	20
4.4.4	Depiction of Instructions	20
5	Device Description	21
5.1	Main Components of the corpuls cpr	21
5.2	Components of the Arm	21
5.3	Stamp	22
5.4	Battery	23
5.4.1	Components of the Battery	24
5.5	Accessories	24
5.5.1	AC Adapter	25
5.5.2	DC Connector Cable	25
5.5.3	SD Card	26
5.5.4	Carrying Bag	26
5.5.5	Compact Backpack	27
5.5.6	Straps	27
5.5.7	Recboard	28
5.5.8	Fixation Ring	28
5.5.9	Scoopboard	29
5.5.10	Stamp Extension	29

5.5.11	Quadboard	30
5.5.12	External Battery Charger	30
6	Before First Use	32
6.1	Unpacking the Device	32
6.2	Checking the Battery	32
6.2.1	Battery Charging Status	32
6.2.2	Charging the Battery	33
6.2.3	Changing the Battery	34
6.3	Inserting the SD Card	35
6.4	Inserting the Stamp	36
6.5	Fixing Attachment Straps on a Board	36
6.5.1	Recboard	36
6.5.2	Scoopboard	37
6.5.3	Forming Hand Loops from Attachment Straps	37
6.5.4	Opening the Hand Loops of the Attachment Straps	39
7	Operation of the Device	40
7.1	Overview of Display and Softkeys	40
7.2	Main Screen	41
7.3	Menu	42
7.3.1	Overview Menu	42
7.3.2	Navigating in the Menu	43
7.3.3	Confirmation Dialogues	43
7.3.4	Configuration Dialogues	44
7.4	Quick Selection Functions	44
7.4.1	Rotating the Display	45
7.4.2	Inverting the Display	45
7.5	Start Screen	45
7.5.1	Start Screen Patient	46
7.5.2	Start Screen Mode	46
7.6	Bluetooth	46
7.6.1	Limitations	46
7.6.2	Requirements	47
7.6.3	User of the Bluetooth Interface	47
7.6.4	Data Management	47
7.6.5	Pairing and Connecting Bluetooth Devices	48
7.6.6	Checking the Bluetooth Status	50
7.6.7	Connection lost	50
7.6.8	Terminating the Bluetooth Connection	51
8	Alarms	52
8.1	Alarm Design	52
8.2	Warnings	52
8.3	Alarms and Messages on the Arm	52
8.3.1	Priorities of the Alarms	52
8.3.2	Alarm Confirmation and Alarm Suspension	58
8.3.3	Notes	60
8.3.4	LED of the Start/Stop Key	60

8.3.5	Messages at Switch Off61
8.4	Battery Alarms.61
9	Therapy65
9.1	Warnings65
9.2	Arrival at the Patient66
9.3	Preparing Therapy.66
9.3.1	Preparing the Patient66
9.3.2	Checking the Stamp Size.67
9.3.3	Assembling the Arm67
9.3.4	Switching On the Arm68
9.3.5	Adjusting the Arm69
9.3.6	Stamp Position Check70
9.4	Therapy Settings71
9.4.1	Configuring Therapy Settings71
9.5	Performing Therapy73
9.5.1	Softstart73
9.5.2	Starting, Stopping/Pausing and Resuming Therapy74
9.5.3	Battery Replacement Concept.75
9.6	Switching Off the Arm75
9.7	Removing the Stamp76
9.8	Disassembling the Arm76
9.9	Synchronised Therapy with corpuls3.77
10	Factory Settings78
11	Configuration at User Level DEFAULT79
11.1	Menu item Bluetooth79
11.2	Menu item User level79
11.3	Menu item Ventilation.80
11.3.1	Therapy Modes 15:2 and 30:2.81
11.3.2	Therapy Mode Cont.82
11.4	Menu item System.83
11.4.1	Info84
11.4.2	LED - Brightness85
11.4.3	Backlight85
11.4.4	Volume86
11.4.5	Time.86
11.4.6	Date.87
11.4.7	Audiovisual Signals.87
11.4.8	Bluetooth settings88
11.4.9	UDI Information89
12	Configuration at User Level OPERATOR90
12.1	Volume90
12.2	Audiovisual Signals90
12.2.1	Turning Key Tones On or Off90
12.2.2	Turning the LED On or Off90
12.2.3	Turning Audio Signals of the Alarm Generator On or Off91
12.2.4	Configuring the Duration of the Alarm Suspension.91

12.2.5	Turning the Reminder Signal On or Off92
12.3	Bluetooth settings92
12.4	Usage Selection93
12.5	Changing Codes94
12.6	Language95
12.7	Patient Settings95
12.8	Start Screen96
12.9	Storing the Configuration97
12.10	Exporting the Configuration97
12.11	Importing the Configuration98
12.12	Changing the Bluetooth PIN98
12.13	Factory Settings98
12.14	Update99
13	Therapy and Transport with the Recboard	102
13.1	Warnings	102
13.2	Therapy with the Recboard	102
13.3	Transport with the Recboard	102
13.4	Patient Securing System	104
13.4.1	Securing the Patient with Straps	104
13.4.2	Securing with the Fixation Ring	106
14	Therapy and Transport with the Scoopboard	109
14.1	Warnings	109
14.2	Therapy with the Scoopboard	109
14.3	Transport with the Scoopboard	110
15	External Battery Charger	112
15.1	Intended Use of External Battery Charger	112
15.2	Intended Use of the External Battery Charger	112
15.3	Operation Statuses	112
15.3.1	Operational Status	113
15.3.2	Error Status	113
15.4	Charging with the External Battery Charger	113
15.5	Battery Removal	113
15.6	Disconnecting from the Mains	113
16	Functional Test and Maintenance	114
16.1	Warnings	114
16.2	Intervals	114
16.3	Selftest	114
16.4	Functional Test	114
16.5	Regular Maintenance Work	117
17	Cleaning and Disinfection	118
17.1	Warnings	118
17.2	Disinfectants	119
17.3	Intervals	120
17.4	Cleaning and Disinfection Procedure	121
17.4.1	Battery	121

17.4.2	Arm	122
17.4.3	Stamp	123
17.4.4	Stamp Extension.	123
17.4.5	Boards	123
17.4.6	Carrying Bags and Straps	123
17.4.7	External Battery Charger.	124

1 Evaluation Software

The software for evaluation of mission data corpuls.manager REVIEW is available free of charge with every device. The software can be downloaded at my.corpuls.world.

2 Performance Description

2.1 Intended Use

The corpuls cpr is a device for electro-mechanical chest compressions within the framework of a cardio-pulmonary resuscitation. Intended use is by professional medical staff on closed thorax patients only.

2.2 Appropriate Use

The following points must absolutely be observed to comply with the intended use:

- The user must have read and understood the user manual
- The user has professional medical training
- The user is trained in basic and advanced resuscitation measures
- Users have been trained in handling the corpuls cpr
- The corpuls cpr is complete, functional and in perfect technical condition
- There are no technical faults and high priority alarms
- The user must supervise the corpuls cpr during therapy in order to be able to intervene in case of error and to continue the therapy manually
- The user only uses approved accessories, spare parts and consumables
- The user is storing and transporting the corpuls cpr exclusively in the pertaining carrying bag
- The user stores, transports and operates the corpuls cpr exclusively in line with the prescribed specifications for storage, transport and operation

2.3 Essential Performances

The essential performances of the corpuls cpr are:

- Treatment in adjusted frequency 80-120 1/min +/- 2 1/min
- Treatment in adjusted compression depth 2-6 cm +/- 5 mm

In case a system error occurs, the corpuls cpr goes into the defined safe state and stops the therapy. The user has to remove the device and has to continue the therapy manually.

2.4 Areas of Application

Areas of application are:

- EMS and patient transport vehicles
- Pre-hospital and intra-hospital emergency care environments (inside and outside of closed rooms)
- Air rescue

2.5 Indication

Indicated patients are adults and children aged eight years and older with circulatory arrest on whom a manual cardio-pulmonary resuscitation can be performed.

2.6 Contraindication

Contraindicated are:

- Patients whose body measurements exceed the permissible limits of the corpuls cpr (see Tab. 5-3 Technical specifications - patient parameters on page 129)
- Patients on which the corpuls cpr cannot be positioned safely and correctly on the thorax
- Patients with injuries that lead to an instability of the thorax and thus prevent effective cardiac massage
- Patients with injuries that are not compatible with life

2.7 Intended Patient Group

Indicated patients are adults and children aged eight years and older with circulatory arrest on whom a manual cardio-pulmonary resuscitation can be performed.

To determine exactly which stamp to use, depending on the height of the patient's thorax see the Technical Specifications (see Tab. 5-3 Technical specifications - patient parameters on page 129). There is no restriction regarding the maximum weight or chest width of the patient.

2.8 Adverse Effects

Adverse effects may occur in manual thorax compressions as well as in mechanical thorax compressions.

Therefore, in the context of a post-resuscitation treatment, special attention should be given to diagnosing and treating the following injuries:

- Rib fractures
- Sternum fractures
- Skin lesions
- Haematomas
- Contusions
- Irritated/reddened skin
- Internal injuries (Pneumothorax, intrathoracic bleeding, intra-abdominal bleeding)

3 Safety

This chapter contains safety-relevant information that has to be observed when operating the corpuls cpr.

3.1 Safety Instructions for the User

The user must read the notices and warnings and follow the instructions. These contain information necessary for safe and disruption-free operation of the device, and help to prevent injuries to users and patients.



WARNING!

Wrong handling due to failure to read the user manual

Can lead to user and patient injury.

- ▶ Read the user manual of the device.



CAUTION!

Neglect of supervisory duty during therapy!

Can lead to injuries of the patient.

- ▶ Supervise the device during therapy.
- ▶ In case of error stop device and continue therapy manually.



WARNING!

Malfunction due to using the device in immediate vicinity of other devices or stacked with other devices!

Can lead to failure of the arm.

- ▶ Do not store the device in the immediate vicinity of other devices or stacked with other devices.
- ▶ Observe devices that have to be used in the immediate vicinity of other devices or stacked with other devices and verify their correct functioning.



WARNING!

Risk of compromising accompanying therapies due to damage of accessories!

Can impair the effectiveness of accompanying therapies and cause those therapies to be terminated.

May result in severe impairment of the patient's health.

- ▶ Ensure that no device parts related to accompanying therapies such as e.g. IV lines, ventilation tubes, defibrillation electrodes and cables are located under the stamp.

3.2 Cyber Security











The aim of cyber security is to protect companies and organisations from unauthorised data access by third parties and from resulting damage such as espionage, sabotage and hacker attacks.















For safe operation of the corpuls cpr, the following points have to be kept in mind:











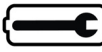





- Change the codes and PIN when commissioning the device
- Codes and PIN should not be changed to sequences of numbers (e.g. 5678)
- The corpuls cpr is invisible for other Bluetooth devices. The user can enable visibility for 120 s
- A Bluetooth connection is only possible with already paired devices (see 7.6.5 Pairing and Connecting Bluetooth Devices on page 48)
- The user must transfer the mission data to the management system at regular intervals and then delete the data from the SD card











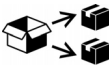





3.3 Symbols













The following table describes the symbols used on the corpuls cpr and its accessories, as well as on its packaging.

Symbol	Designation	Description
	System error	Symbol on the display of the arm. The arm signals the alarm ♦System error♦.
	Malfunction	Symbol on the display of the arm. The arm signals the alarm ♦Malfunction♦.
	Therapy stopped for longer than 8 s	Symbol on the display of the arm. The arm signals the alarm ♦Therapy stopped for longer than 8 s♦.
	Battery charging status very low	Symbol on the display of the arm. The arm signals the alarm ♦Battery charging status very low♦.
	Battery not ready for use	Symbol on the display of the arm. The arm signals the alarm ♦Battery not ready for use♦. The battery is defective or empty.
	Open the locking lever	Symbol on the display of the arm. The arm signals the alarm ♦Open the locking lever♦.
	Close the locking lever	Symbol on the display of the arm. The arm signals the alarm ♦Close the locking lever♦.
	Arm too low	Symbol on the display of the arm. The arm signals the alarm ♦Arm too low♦.
	Temperature of the arm very high	Symbol on the display of the arm. The arm signals the alarm ♦Temperature of the arm very high♦.
	Connection lost	Symbol on the display of the arm. The arm signals the alarm ♦Connection lost♦ during synchronised therapy with the corpuls3 .

Symbol	Designation	Description
	Battery charging status low	Symbol on the display of the arm. The arm signals the alarm ♦Battery charging status low♦.
	Battery life	Symbol on the display of the arm. The arm signals the alarm ♦Battery life♦.
	Customer service for battery	Symbol on the display of the arm. The arm signals the alarm ♦Customer service for battery♦.
	Self-test failed	Symbol on the display of the arm. The arm signals the alarm ♦Self-test failed♦.
	RTC error	Symbol on the display of the arm. The arm signals the alarm ♦RTC error♦.
	Overload	Symbol on the display of the arm. The arm signals the alarm ♦Overload♦.
	Therapy stopped	Symbol on the display of the arm. The arm signals the alarm ♦Therapy stopped♦.
	Arm too high	Symbol on the display of the arm. The arm signals the alarm ♦Arm too high♦.
	Arm too low	Symbol on the display of the arm. The arm signals the alarm ♦Arm too low♦.
	Temperature of the arm high	Symbol on the display of the arm. The arm signals the alarm ♦Temperature of the arm high♦.
	Customer service for battery	Symbol on the display of the arm. The arm signals the alarm ♦Customer service for battery♦ when performing the selftest.
	SD card error	Symbol on the display of the arm. The arm signals the alarm ♦SD card error♦.
	SD card almost full	Symbol on the display of the arm. The arm signals the alarm ♦SD card almost full♦.
	SD card full	Symbol on the display of the arm. The arm signals the alarm ♦SD card full♦.
	Charging not possible	Symbol on the display of the arm. The arm signals the alarm ♦Charging not possible♦.

Symbol	Designation	Description
	Customer Service	Symbol on the display of the arm. The arm signals the message <Customer service>.
	Customer service for battery	Symbol on the display of the arm. The arm signals the message <Customer service for battery> at the end of the mission.
	Arm too high	Symbol on the display of the arm. The arm signals the message <Arm too high>.
	Arm too low	Symbol on the display of the arm. The arm signals the message <Arm too low>.
	Open the locking lever	Symbol on the display of the arm. The arm prompts for initial opening of the locking lever.
	Defibrillation proof application part, type BF	Symbol on the stamp. The stamp is a defibrillation proof application part, type BF.
	Bluetooth	Symbol on the keypad. The arm has Bluetooth functionality.
	Bluetooth (Discovery mode)	Symbol on the display of the arm. If the symbol flashes, the arm is in discovery mode. There is no Bluetooth connection to a Bluetooth device.
	Bluetooth connection	Symbol on the display of the arm. There is a Bluetooth connection to a Bluetooth device.
	Bluetooth connection (multi data transmission)	Symbol on the display of the arm. There is a Bluetooth connection to two Bluetooth devices.
	No Bluetooth	Symbol on the display of the arm. Bluetooth connection not possible.
	Bluetooth data transmission	Symbol on the display of the arm. There is a Bluetooth connection with data transmission.
	NFC	Symbol on the keypad. The arm has NFC functionality.
	Read the user manual	Symbol on the keypad. Note to read the user manual.
	Rotating the screen	Symbol on the keypad. The display of the arm can be rotated by means of the two softkeys beside the screen.
	Inverting screen colours	Symbol on the keypad. The display of the arm can be inverted by means of the two softkeys beside the screen.
	Importer	Indicates the entity importing the medical device into the locale.

Symbol	Designation	Description
	Distributor	Indicates the entity distributing the medical device into the locale.
	Repackaging	To identify that a modification to the original medical device packaging configuration has occurred.
	Medical device	Indicates that the item is a medical device.
	Unique Device Identifier	Indicates a carrier that contains Unique Device Identifier information.
	Product number	Indicates the product number for a device.
	Serial number	Indicates the serial number for a device.
	Version number	Indicates the version number for a device.
	Rechargeable	Symbol on the rating plate of the battery. Indicates a rechargeable battery.
	Input	Symbol on the rating plate of the battery.
	Output	Symbol on the rating plate of the battery.
	GS company logo	Shows the company logo of GS Elektromedizinische Geräte G. Stemple GmbH.
	Manufacturer	Indicates the manufacturer of the device.
	Do not dispose of in household waste	Do not dispose of the corpuls cpr and its accessories in household waste.
	Protection class	Symbol on the corpuls cpr and its accessories. The device is protected against environmental influences as indicated.
	RCM symbol	Symbol "Regulatory Compliance Mark".
	CE symbol	Symbol of CE conformity.
	Device with protection class II	Symbol on the external battery charger. The device has no protective conductor connection of its own.
	Caution	Symbol on the rating plate of the battery. Handling the battery requires increased care.

Symbol	Designation	Description
	Do not heat up battery	Symbol on the rating plate of the battery. The battery may not be heated.
	Do not open or damage the battery	Symbol on the rating plate of the battery. The battery may not be damaged or opened.
	Read the user manual or the electronic user manual	Indicates that the user must observe the User Manual.
	Keep dry	Indicates a medical device that has to be protected from wetness/moisture.
	Fragile, handle with care	Indicates a medical device that can break or be damaged when handled carelessly.
	Protect from (sun)light	Indicates a medical device that has to be protected from light sources.
	Temperature limit	Indicates the temperature limit values to which the medical device can be exposed safely.
	Here is the top	To indicate correct upright position of the transport package.
	Alarm suspension	Symbol on the display of the arm. Next to the alarm line, the arm signals an alarm that can be suspended.
	Alarm suspended	Symbol on the display of the arm. The arm signals a suspended alarm in the display field "Info".
	Charge	Symbol on the display of the arm. The arm indicates that charging is in progress in the display field "Info".
	Charging status	Symbol on the display of the arm. The arm signals the charging status in the display field "Info".
	Charging of battery not possible	Symbol on the display of the arm. The arm indicates that charging is not possible in the display field "Info".

Tab. 3-1 Symbols

4 Directions for Users

This chapter includes all relevant information that has to be minded when using this user manual.

4.1 Requirements for the User

In order to use the corpuls cpr, users must meet the following requirements (amongst others):

- Users have to be professional medical personnel
- Users must be trained in basic and advanced resuscitation measures
- Users have been trained in handling the corpuls cpr. Applicable national laws and guidelines must be observed during training on the device



Applicable regional and/or international guidelines on cardio-pulmonary resuscitation (CPR) must be observed when operating the corpuls cpr.

4.2 Clinical Benefit

The corpuls cpr and its accessories enable guideline-compliant mechanical chest compressions in clinical, emergency medical services and military environments in continuous, 30:2 and 15:2 mode, especially in situations where manual chest compression cannot be safely provided in a guideline-compliant manner.

In combination with a corpuls3 patient monitor / defibrillator, the corpuls cpr can provide automated interruption of the chest compressions for rhythm analysis and shock delivery which allows for a short hands-off time.

The accessories (e.g. boards) enable the corpuls cpr to be used in accordance with its intended purpose or to specifically and directly assist the medical functionality of the corpuls cpr in terms of its intended purpose.

4.3 Training Concept

To guarantee safe use of our devices on patients, the manufacturer relies on a comprehensive training concept which includes the following elements:

- E-Learning
- On site training
- Webinars and online trainings
- Further information, e.g. whitepapers

The training concept addresses different target audiences, e.g. multipliers on the part of the manufacturer and the operator as well as users.

The information in this chapter is of general nature, as additional regulatory stipulations, e.g. for the qualification of medical device consultants have to be considered.

All training concepts will be adapted to the conditions of the customer, e.g. to specifications of device configuration or existing basic medical qualifications of the users.

4.3.1 Target audience

Multiplicators on the part of the manufacturer

Multiplicators on the part of the manufacturer are e.g. clinical educators, product specialists, employees in sales or other persons who have the qualification of medical device consultant pursuant to German medical device legislation.

Objectives	<p>Multiplicators on the part of the manufacturer are fully trained multiplicators on the part of the operator and users. Furthermore, they have the following skills:</p> <ul style="list-style-type: none"> • They can advise customers and potential customers in matters of configuration and use of the product and to answer technical questions • They can recommend technical features and accessories • They can plan and implement trainings of users and multiplicators on the part of the customer/operator • They can prepare reports of malfunctions or incidents in such a way that these can be analysed and evaluated by the competent specialist departments and/or authorities
Implementation concept	<p>Further qualification is based on a full user training (see User on page 18). For the target audience of multiplicators on the part of the manufacturer each year several national and international on site trainings are offered which aim to impart the necessary competence to advise and train customers.</p> <p>Besides the on site trainings, trainings on e.g. special topics or new features are offered via webinars, online trainings and E-learning. With relevant changes in the hard- or software, attendance is mandatory to keep the competence record valid.</p> <p>The obtained competence records have limited validity, which should ensure regular attendance at the offered advanced trainings.</p> <p>Multiplicators on the part of the customer/operator</p> <p>Multiplicators on the part of the customer/operator are persons who perform the role of person responsible for the device commissioned by the operator pursuant to German medical device legislation.</p>
Objectives	<p>Multiplicators on the part of the customer/operator are full trained users. Furthermore, they have the following skills:</p> <ul style="list-style-type: none"> • Knowing the configuration options of the device, they can implement these according to the respective use cases • They know the stipulations specific to the operator, such as maintenance- and inspection periods • They can advise the user on device related issues • They can plan and implement a user training according to the overall concept and the objectives • Knowing the reporting channels, they can analyse and describe malfunctions or incidents on the part of the operator and report these as intended
Implementation concept	<p>This target audience is always trained by the multiplicators on the part of the manufacturer in order to maintain corresponding quality standards. For the training of this target audience, the manufacturer offers standardised training materials and training concepts.</p> <p>Also the qualification to be a multiplicator on the part of the customer/operator is based on a full user training and is comprised of all elements mentioned above.</p> <p>User</p> <p>Users are all persons who work with devices by the manufacturer on a patient. They are trained on principle by multiplicators on the part of the customer/operator.</p>
Objectives	<p>Users have the following skills:</p> <ul style="list-style-type: none"> • They know the essential features of the device • They know the areas of application and pertaining limitations • They can use the device safely on a patient • They can perform reprocessing as intended after use in a mission • They can perform functional checks as described in the user manual • They can react adequately to malfunctions
Implementation concept	<p>The training concept for users consists of a comprehensive E-learning course for theoretical preparation and an on site training. In the latter, particular attention is given to exploring the functions relevant in day-to-day work.</p>

Also for this target audience, the manufacturer offers standardised training materials and training concepts which are regularly updated.

The basic responsibility of qualifying the users lies with the operator/customer.

4.3.2 Taking into Account Country-Specific Requirements

Requirements on the training concepts implemented for the respective customers are defined by country-specific normative regulations as well.

In those cases, the manufacturer matches the central training concept individually to the conditions of the customer.

4.3.3 Initial Product Training

The initial instruction and training on the device must be performed by the manufacturer or by authorised personnel. With each significant modification of the product or its accessories the user has to be trained again on the product and its accessories.

4.4 Use of this Manual

The user manual has been compiled to enable better understanding of the corpuls cpr. The user must read through the user manual from beginning to end.

The user manual provides users with the following information:

- Safe and disruption-free operation of the corpuls cpr
- Treatment of the patient with the corpuls cpr
- Maintenance of the corpuls cpr
- Troubleshooting

In addition to this user manual, the currently applicable laws, statutory- and hygiene regulations, generally accepted rules of technology as well as regulations for occupational health and safety and accident prevention must be complied with.

4.4.1 Typographic Conventions

The following typographic conventions apply in this user manual:

[Softkey]	Indicates a softkey.
<i>Menu item</i>	Indicates a menu item.
> <i>Submenu item</i>	Indicates a submenu item.
<Note>	Indicates an explanatory message.
◆Alarm◆	Indicates an alarm message.
Key	Indicates a key.

Tab. 4-1 Typographic conventions

4.4.2 Depiction of Warnings

Warnings alert the user of possible sources of danger. Warnings are categorised into four levels of danger. The levels of danger DANGER, WARNING and CAUTION denote bodily injuries. The danger level NOTICE indicates material- and environmental damage. Warnings for a chapter are listed at the beginning of the chapter. The user must heed warnings.



DANGER!

A hazard with a high degree of risk which, if not avoided, will result in death or serious injury.



WARNING!

A hazard with a medium degree of risk which, if not avoided, may result in death or serious injury.



CAUTION!

A hazard with a low degree of risk which, if not avoided, may result in minor or moderate injury.

NOTICE!

A hazard with a low degree of risk which, if not avoided, may result in minor or moderate damage to property or the environment.

4.4.3 Depiction of Notices



Notes point out important information which the user must heed when carrying out an instruction. Notes provide the user with additional information on a particular issue.

4.4.4 Depiction of Instructions

An instruction describes the steps the user has to perform to complete the task.



The symbol in the margin indicates an instruction and the pertaining steps. The instruction consists of the goal description, the pre-requisites, the individual steps and the results of a step.

5 Device Description

This chapter contains descriptions of the parts of the corpuls cpr.

5.1 Main Components of the corpuls cpr

The corpuls cpr system is composed of:

- An arm as the central electromechanical unit, with:
 - A stamp in two sizes (see 5.3 Stamp on page 22)
 - A battery as a power supply (see 5.4 Battery on page 23)
 - An AC adapter for charging the battery (see 5.5.1 AC Adapter on page 25)
- One of three board options:
 - Quadboard for in-hospital therapy (see 5.5.11 Quadboard on page 30)
 - Recboard for pre-hospital and in-hospital therapy and patient transport (see 5.5.7 Recboard on page 28)
 - Scoopboard for pre-hospital and in-hospital therapy and patient transport (see 5.5.9 Scoopboard on page 29)

5.2 Components of the Arm

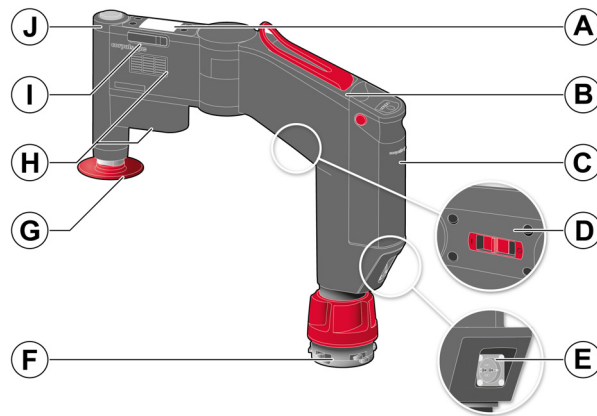

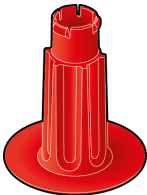

Fig. 5-1 Components of the arm

Item	Component	Description
A	Monitor unit with screen and softkeys	The following functions are available: <ul style="list-style-type: none"> Control of the functions of the arm (see 7 Operation of the Device on page 40) Display of alarms in the alarm line of the screen (see 8 Alarms on page 52) Status information for Bluetooth connection (see 7.6.6 Checking the Bluetooth Status on page 50)
B	Locking lever	Immobilisation of the arm.
C	Battery	Supplies power to the arm.
D	On/Off switch	Switches the arm on or off.
E	RoPD charging connector	Connects the arm to an external power supply.
F	Bayonet lock	Allows assembly of the arm on one of the boards, e.g. on the Quadboard or the Recboard (see 9.3.3 Assembling the Arm on page 67).
G	Stamp	Transfers the compressions of the arm to the thorax of the patient (see 5.3 Stamp on page 22).
H	Ventilation slots	Part of the cooling system of the arm.
I	SD card slot	Card slot for the SD card (see 5.5.3 SD Card on page 26).
J	Start/Stop key	The following functions are available: <ul style="list-style-type: none"> Starting therapy (see 9.5 Performing Therapy on page 73) Pausing or stopping therapy (see 9.5 Performing Therapy on page 73) Indicating alarms via the integrated LED (see 8 Alarms on page 52)

Tab. 5-1 Components of the arm

5.3 Stamp

The stamp transfers compression from the arm to the thorax of the patient.

Illustration	Size	Use	Thorax height that can be treated
	Long	For patients with low thorax height and children aged eight years and older	<ul style="list-style-type: none"> Quadboard: 13.3-28.2 cm Recboard: 12.8-27.4 cm Scoopboard: 12.6-27.1 cm
	Short	For patients with high thorax height	<ul style="list-style-type: none"> Quadboard: 19.3-34.2 cm Recboard: 18.4-33.5 cm Scoopboard: 18.6-33.0 cm

Tab. 5-2 Stamp sizes



It is the responsibility of the user to select a stamp of the correct size.

5.4 Battery

A battery supplies power to the arm.

The display unit of the arm shows the remaining running time of the battery in minutes (see 7.1 Overview of Display and Softkeys on page 40).



When the arm is connected to the AC adapter, the symbol  appears in the display field "Info". The display shows the current charging status of the battery in percent.



WARNING!

Fire hazard due to short circuit!

Can lead to patient or user injury as a result of electric shock or burns.

- ▶ Defective batteries must be replaced immediately.
- ▶ In the event of impact or jolts, check the battery for external damage such as breakage of the housing or open adhesive joints.
- ▶ Do not expose battery to fire or heat.
- ▶ Do not open or damage the battery.

NOTICE!

Short circuit due to damaged battery!

Can cause damage to the battery and the arm of the corpuls cpr.

- ▶ Defective batteries must be replaced immediately.
- ▶ In the event of impact or jolts, check the battery for external damage such as breakage of the housing or open adhesive joints.

NOTICE!

Deep discharge of battery due to non-use!

Can cause damage to the battery and can lead to failure of the arm of the corpuls cpr.

- ▶ Do not store the reserve battery for too long.
- ▶ Use the battery and the reserve battery in turns.
- ▶ Store the reserve battery in the external battery charger.



A damaged battery is indicated when switching the arm on or off (see 8.3.1 Priorities of the Alarms on page 52).



Under the conditions indicated in this user manual (see V Technical Specifications on page 129) the battery can stay connected to the mains permanently without any negative effects on the product life span.

5.4.1 Components of the Battery

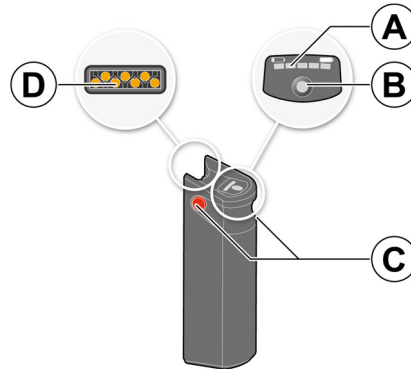

Fig. 5-2 Components of the battery

Item	Component	Description
A	Battery display	The following displays are available: <ul style="list-style-type: none"> • Battery charging status • Charging process of the battery • Battery alarms
B	Key Charging status	The following functions are available: <ul style="list-style-type: none"> • Activates the charging status (see 6.2 Checking the Battery on page 32) • Activates the alarm indication (see 8.4 Battery Alarms on page 61)
C	Unlocking buttons (on both sides)	Allow to unlock the battery.
D	Contact field	Electrical contact field to the arm.

Tab. 5-3 Components of the battery

5.5 Accessories

The following accessories are available for the corpuls cpr (excerpt):

- AC adapter
- DC connector cable
- SD Card
- Carrying bag
- Straps
- Scoopboard
- Recboard
- Fixation ring
- Quadboard
- External battery charger



A complete list of approved accessories and consumables can be found at my.corpuls.world.



If the corpuls cpr is equipped with accessories, the user must mind the information regarding the accessories.

5.5.1 AC Adapter

The AC adapter is an external power supply for the arm and for charging the battery. The AC adapter can be connected to the arm or to the external battery charger.



Fig. 5-3 AC adapter



Using an AC adapter, the battery can also be charged during therapy. In this case, the battery charging time increases (see 6.2 Checking the Battery on page 32).

5.5.2 DC Connector Cable

The DC connector cable supplies power to the arm or the external battery charger. The user can charge the battery with the DC connector cable via the on-board power supply of the emergency vehicle or automobile (see 6.2 Checking the Battery on page 32).

Three types of DC connector cable are available:

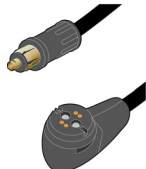
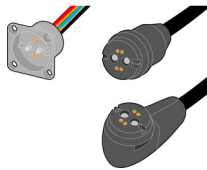
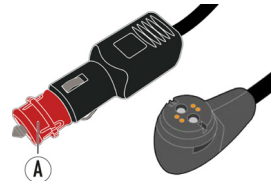
Variant	Illustration	Designation
1		Standard connector (ISO 4165) on RoPD/angled
2		RoPD/straight on RoPD/angled (RoPD connection port for assembly in emergency vehicles)
3		Vehicle connector (cigarette lighter) on RoPD/angled. The user may use the vehicle connector only in combination with the red reduction ring/bushing (A).



Using a DC connector, the battery can also be charged during therapy. In this case, the battery charging time increases (see 6.2 Checking the Battery on page 32).



For optimum charging performance, the manufacturer recommends using RoPD/straight on RoPD/angled with an RoPD connection port.

5.5.3 SD Card

The SD™ card allows:

- Installing system updates which are available in various languages (see 12.14 Update on page 99)
- System configurations to be imported and exported (see 12.11 Importing the Configuration on page 98)
- Mission data to be recorded

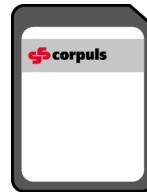

Fig. 5-4 SD™ card

5.5.4 Carrying Bag

With the carrying bag, the user can safely transport and store the corpuls cpr and its accessories. The user must use the carrying bag to safely transport and store the Quadboard or the Recboard. With the backpack straps, the carrying bag can also be used as a backpack.

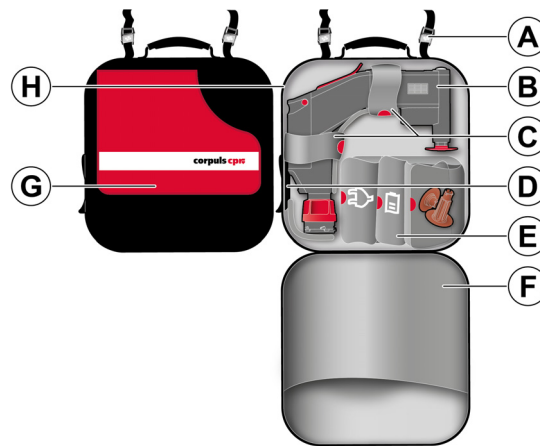

Fig. 5-5 Carrying bag

Item	Component	Description
A	Magnetic lock	Attaches the carrying bag magnetically to a wall, e.g. in a hospital.
B	Position of the arm	Position of the stored arm with pre-connected stamp.
C	Velcro fasteners	Immobilise the arm in the carrying bag.
D	Cover flap	Allows the battery to be charged in the compact backpack (see 6.2.2 Charging the Battery on page 33).
E	Storage compartments for accessories	Allows the accessories to be stored in the carrying bag.
F	Storage compartment	Allows the straps to be stored in the carrying bag.
G	Board storage compartment	Allows the Quadboard or the Recboard to be stored in the carrying bag.
H	Viewport	Allows to check the charging status of the battery (see 6.2.1 Battery Charging Status on page 32).

Tab. 5-4 Carrying bag



The manufacturer recommends to carry two of each stamp variant (see 5.3 Stamp on page 22).

5.5.5 Compact Backpack

The user can safely transport and store the corpuls cpr with its accessories in the compact backpack. The user must use the compact backpack to safely transport and store the Scoopboard.

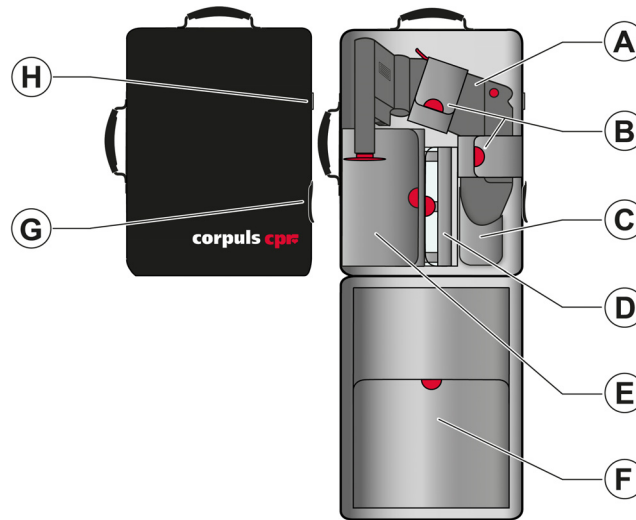

Fig. 5-6 Compact backpack

Item	Component	Description
A	Position of the arm	Position of the stored arm with pre-connected stamp.
B	Velcro fasteners	Fasten the arm in the compact backpack.
C	Insert pocket	Positions the arm in the compact backpack.
D	Storage compartment, small	Allows to store the stamp.
E	Storage compartment, medium	Allows to store the AC adapter and the reserve battery.
F	Storage compartment, big	Allows to store the Scoopboard and the Fixation Ring.
G	Cover flap	Allows the battery to be charged in the compact backpack (see 6.2.2 Charging the Battery on page 33).
H	Viewport	Allows to check the charging status of the battery (see 6.2.1 Battery Charging Status on page 32).



The manufacturer recommends to carry two of each stamp variant (see 5.3 Stamp on page 22).

5.5.6 Straps

The Straps allow to securely position and transport the patient on an appropriate transport device. In combination with the arm, the Recboard or the Scoopboard therapy is also possible during transport (see 13.4 Patient Securing System on page 104). With an appropriate head restraint, immobilisation for trauma care is also possible.



For securing the patient in the transport vehicle the existing restraint systems must be used. The restraint systems must not impair therapy with the corpuls cpr. In particular, one must ensure sufficient compression and full release of the thorax as well as unhindered access to the therapy zone of the corpuls cpr.

5.5.7 Recboard

The Recboard allows:

- To perform in-hospital and pre-hospital therapy with the arm of the corpuls cpr (see 13.2 Therapy with the Recboard on page 102)
- Transport of the patient while therapy is in progress, if an appropriate transporting device is used (see 13.3 Transport with the Recboard on page 102)

The following illustration provides an overview of the components of the Recboard.

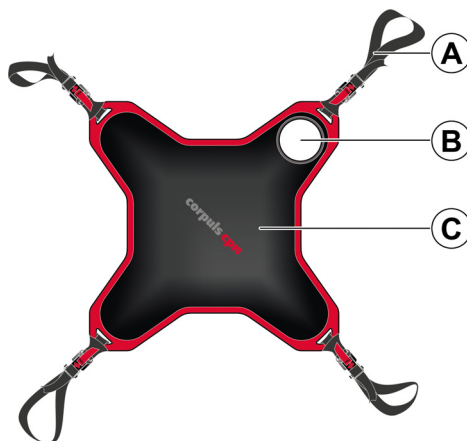

Fig. 5-7 Components of the Recboard

Item	Component	Description
A	Attachment straps	The following functions are available: <ul style="list-style-type: none"> • Allow to secure the Recboard on a carrying device • Allow to easily lift the Recboard with the patient by means of the hand loops • Allow to secure the patient on the Recboard by means of the Fixation Ring
B	Socket for the arm	Allows assembly of the arm on the Recboard.
C	Recboard	Board for therapy with the arm.

Tab. 5-5 Components of the Recboard

5.5.8 Fixation Ring

The Fixation Ring allows to secure the patient on the Recboard or on the Scoopboard by means of the Straps. The Fixation Ring has to be used if the use of the Straps for securing the patient is not possible, e.g. when transporting the patient with a rescue sheet. The following section explains the use of the Fixation Ring with the example of patient transport with a rescue sheet.



The manufacturer recommends a rescue sheet with a foot bag for patient transport.

The following illustration provides an overview of the components of the Fixation Ring.

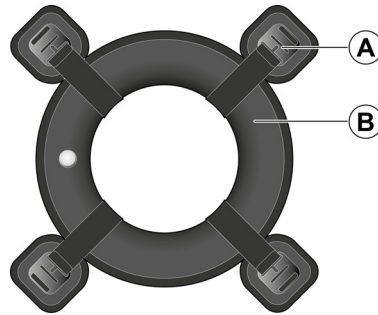

Fig. 5-8 Components of the fixation ring

Item	Component	Description
A	Magnetic clasp	Part of the buckle of the Fixation Ring serving to secure the attachment straps at the Fixation Ring.
B	Ring	Distributes the traction force evenly around the therapy zone.

Tab. 5-6 Components of the fixation ring

5.5.9 Scoopboard

The Scoopboard allows:

- To perform in-hospital and pre-hospital therapy with the arm of the corpuls cpr (see 14.2 Therapy with the Scoopboard on page 109)
- Transport of the patient while therapy is in progress, if an appropriate transporting device, such as a rescue sheet or scoop stretcher is used (see 14.3 Transport with the Scoopboard on page 110)

The following illustration provides an overview of the components of the Scoopboard.

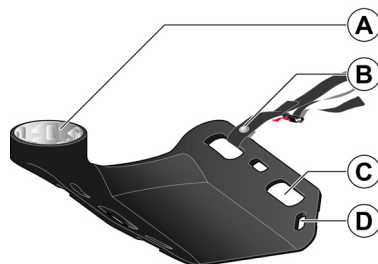

Fig. 5-9 Components of the Scoopboard

Item	Component	Description
A	Socket for the arm	Allows assembly of the arm on the Scoopboard.
B	Attachment straps	The following functions are available: <ul style="list-style-type: none"> • Allow to secure the Scoopboard on a carrying device • Allow to easily lift the Scoopboard with the patient by means of the hand loops • Allow to secure the patient on the Scoopboard by means of the Fixation Ring
C	Handles	Allow to lift the Scoopboard.
D	Eyelets for attachment straps	Allow to install the attachment straps.

Tab. 5-7 Components of the Scoopboard

5.5.10 Stamp Extension

With the stamp extension, the higher position of the arm that is caused by being assembled on the Scoopboard, can be compensated.



Fig. 5-10 Stamp extension



When using the Scoopboard, always insert the stamp extension.

5.5.11 Quadboard

The Quadboard allows in-hospital therapy using the arm of the corpuls cpr (see 9 Therapy on page 65). The following illustration provides an overview of the components of the Quadboard.

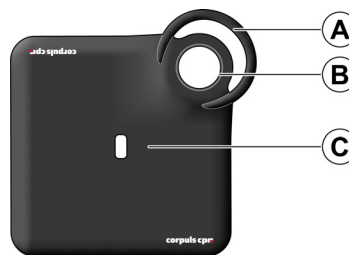

Fig. 5-11 Components of the Quadboard

Item	Component	Description
A	Carrying handle	Allows to transport the Quadboard.
B	Socket for the arm	Allows to assemble the arm on the Quadboard.
C	Quadboard	Board for therapy with the arm.

Tab. 5-8 Components of the Quadboard

5.5.12 External Battery Charger

The external battery charger allows to charge the battery outside of the arm. The following illustration provides an overview of the components of the external battery charger.

The external battery charger can be used as follows:

- Use as desktop charger
- Use as wall-mounted charger

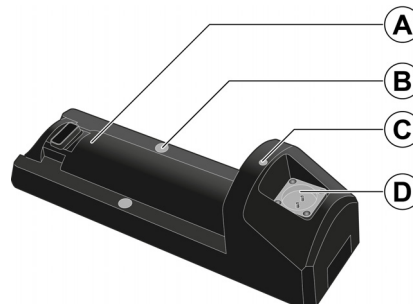

Fig. 5-12 External battery charger

Item	Component	Description
A	Battery shaft	Mechanical and electrical coupling for the battery.
B	Wall-mounting recesses	Allow mounting on a wall.
C	Status display	LED for displaying the status of the external battery charger.
D	Mains connection	Allows to connect the AC adapter or the DC connector cable.

Tab. 5-9 External battery charger



The external battery charger may not be installed in airplanes.

6 Before First Use

This chapter contains basics with which users must familiarise themselves before using the device for the first time.

6.1 Unpacking the Device

Contact your authorised sales and service partner immediately in the following cases:

- If the packaging is damaged or opened;
- If the device is damaged
- If parts of the device or the accessories are missing



Keep the transport box and the packaging material stored (see 16.5 Regular Maintenance Work on page 117).

6.2 Checking the Battery

The battery guarantees the power supply to the corpuls cpr arm.

6.2.1 Battery Charging Status

The charging status of the battery is shown on the battery display separately from the operational status of the arm. The number of LEDs lit indicates the charging status of the battery. One LED lit in orange indicates that the battery is empty.

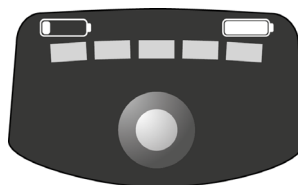

Fig. 6-1 Battery display

Battery charging status					
0 %	1 % to 20 %	21 % to 40 %	41 % to 60 %	61 % to 80 %	81 % to 100 %

Tab. 6-1 Battery charging status



The LEDs only light up when the battery is inserted in a switched-on arm or in an external battery charger that is connected to the mains supply. If a battery is not inserted or if the arm is not switched on, the **Charging status** key activates the battery display LEDs for 3 s.



As the battery discharges itself if stored over a longer period of time, the battery charging status must be checked regularly. To prevent deep discharge of a battery, the battery and the replacement battery must be used regularly in turns, or the replacement battery must remain in the external battery charger.



To display the charging status of the battery, proceed as follows:

1. Press the key Charging status (see 5.4.1 Components of the Battery on page 24).
The LEDs of the battery display show the battery charging status for 3 s.

6.2.2 Charging the Battery

To charge the battery, the following options are available:

- AC adapter (see 5.5.1 AC Adapter on page 25)
- DC connector cable (see 5.5.2 DC Connector Cable on page 25)

While charging is in progress, the battery remains inserted in the arm (see 6.2.3 Changing the Battery on page 34). The user can charge the battery with the arm switched on or off. The charging time of the battery can be found in the technical specifications (see V Technical Specifications on page 129). Optionally, the battery can also be charged in the external battery charger.



The user can operate the arm while charging is in progress.

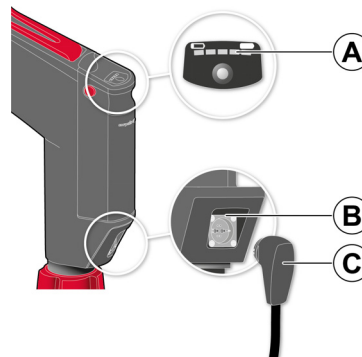

Fig. 6-2 Charging the battery

Item	Component	Description
A	Battery display	The following displays are available: <ul style="list-style-type: none"> • Battery charging status • Charging process of the battery • Battery alarms
B	RoPD contact field	Forms the connection between the arm and the power supply together with the RoPD connector.
C	RoPD connector	Forms the connection between the arm and the power supply together with the RoPD contact field.

Tab. 6-2 Charging the battery

To charge the battery, proceed as follows:



Prerequisite:

- ✓ The battery is inserted correctly in the arm (see 6.2.3 Changing the Battery on page 34)
- ✓ The AC adapter or the DC connector cable are connected to a power supply

1. Connect the RoPD connector to the RoPD contact field of the arm.
The battery is charging. The LEDs of the battery display indicate that battery charging is in progress by flashing steadily.
The symbol  appears in the display field "Info" (see 7.1 Overview of Display and Softkeys on page 40).

- i** The number of flashing LEDs corresponds to the current battery charging status (see 6.2.1 Battery Charging Status on page 32).
- i** The display of the switched-on arm indicates the charging status of the battery in percent while charging is in progress (see 7.1 Overview of Display and Softkeys on page 40).
- i** If the battery is fully charged and still connected to the power supply, all LEDs are glowing green.
- i** Under the conditions indicated in this user manual (see V Technical Specifications on page 129) the battery can stay connected to the mains permanently without any negative effects on the product life span.
- i** To avoid therapy delays, the battery charging status must be >60 %. 61 % charging status and more correspond to at least four lit or flashing LEDs.
- i** In ambient temperatures lower than 0 °C, the actual remaining running time of the battery can differ from the displayed remaining running time.
- i** The battery can only be charged within a temperature range of 0 °C to 45 °C.

6.2.3 Changing the Battery

The battery of the arm can be replaced with an equivalent battery. Users can replace the battery themselves.

- i** The battery may only be replaced with a battery designated by the manufacturer as an approved accessory (see III Approved accessories and consumables on page 127).

The battery must be replaced when:

- The alarm ♦Battery charging status very low♦ is shown
- The alarm ♦Battery charging status low♦ appears and the user cannot connect the arm to an external power supply (see Medium priority alarms on page 56)
- The battery has reached maximum life span (see V Technical Specifications on page 129)
- The battery is damaged
- The LEDs of the battery display indicate an error (see 8.4 Battery Alarms on page 61)
- The message or alarm message ♦Customer service for battery♦ appears

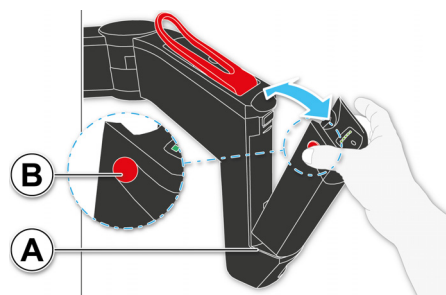

Fig. 6-3 Changing the battery

Item	Component	Description
A	Battery hold	Allows to insert the battery into the arm.
B	Unlocking buttons (on both sides)	Allow to unlock the battery.

Tab. 6-3 Changing the battery

To replace the battery, proceed as follows:



Prerequisite:

- ✓ The charging status of the replacement battery is at least 60 % (3 LEDs lit)
1. Press the unlocking button at both sides of the battery.
The battery is unlocked.
 2. Tilt the upper part of the battery backwards.
 3. Remove the battery.
 4. Insert the replacement battery with the lower part into the battery holder of the arm.
 5. Push the upper part of the replacement battery forwards until it snaps into place.



Therapy cannot begin until the battery has clicked into place.



The arm temporarily saves settings that have been changed by the user while the arm is in operation. If the user removes the battery for a maximum of 30 s, these settings will still be available after re-inserting the battery. Otherwise, the user has to re-adjust the settings.



If the remaining battery running time/capacity falls to less than 20 % or 5 minutes, the arm shows an alarm in each case (see 8.3 Alarms and Messages on the Arm on page 52).

6.3 Inserting the SD Card

To use all functions of the SD card (see 5.5.3 SD Card on page 26), the SD card must be inserted into the arm.

To insert the SD card, proceed as follows:



1. Open the cover of the SD card slot (see 5.5.3 SD Card on page 26).
2. Insert the SD card into the SD card slot.

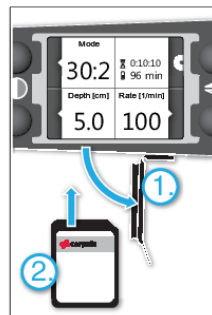

Fig. 6-4 Inserting the SD card



The printed side must face upwards and the marked corner on the right side must point towards the SD card slot.

3. Close the cover of the SD card slot.



Without the SD card, the arm issues a low-priority alarm (see 8.3 Alarms and Messages on the Arm on page 52).



In order to prevent the loss of data, first switch off the arm before removing the SD card.

6.4 Inserting the Stamp

To ready the arm for use, the user must insert the stamp into the arm.

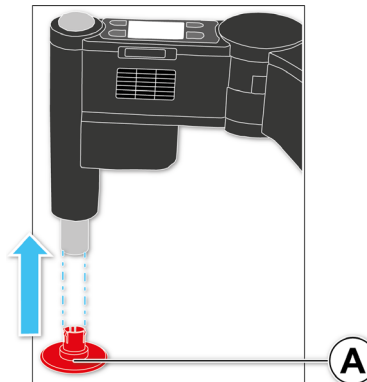

Fig. 6-5 Inserting the stamp

Item	Element	Description
A	Stamp	Allows transfer of compression from the arm to the thorax of the patient.

Tab. 6-4 Inserting the stamp

To insert the stamp into the arm, proceed as follows:



1. Insert the stamp from below into its holder at the arm and push in as far as it will go. The stamp clicks into position.

6.5 Fixing Attachment Straps on a Board

6.5.1 Recboard

Before using the Recboard for the first time, the attachment straps must be secured to the Recboard. The following instruction describes the assembly of the attachment straps on the Recboard using an anchor loop.



Fig. 6-6 Recboard with the attachment strap open

Item	Component	Description
A	Attachment strap loop	Part of the attachment strap.
B	Recboard eyelet	Allows to secure the attachment strap to the Recboard.
C	End of the attachment strap with fastener	Part of the attachment strap.

Tab. 6-5 Recboard with the attachment strap



To secure the attachment strap to the Recboard, proceed as follows:

1. Insert the end of the attachment strap (item C) from above through the Recboard eyelet (item B).
2. Guide the end of the attachment strap (item C) completely through the attachment strap loop (item A) and pull tight.



Fig. 6-7 Recboard with closed attachment strap

The attachment strap is secured to the Recboard.



In addition to the attachment strap pictured, the attachment strap for the Scoopboard can be used as well. Fastening the attachment straps to the Recboard is analogous to fastening them to the Scoopboard (see 6.5.2 Scoopboard on page 37).

6.5.2 Scoopboard

Before using the Scoopboard for the first time, the attachment straps must be secured to the Scoopboard. The following instruction describes the assembly of the attachment straps on the Scoopboard.

To secure the attachment strap to the Scoopboard, proceed as follows:



1. Guide the end of the attachment strap from above through the eyelet of the Scoopboard.
2. Close the snap fastener.

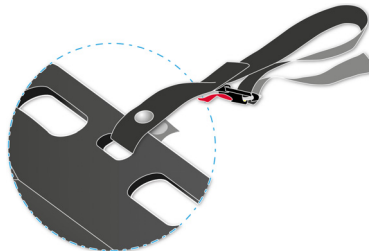

Fig. 6-8 Scoopboard with the attachment strap

The attachment strap is secured to the Scoopboard.

6.5.3 Forming Hand Loops from Attachment Straps

Before using a board for the first time, the four attachment straps must be closed to form hand loops. The buckles of the attachment straps are magnetic and easy to open and close.

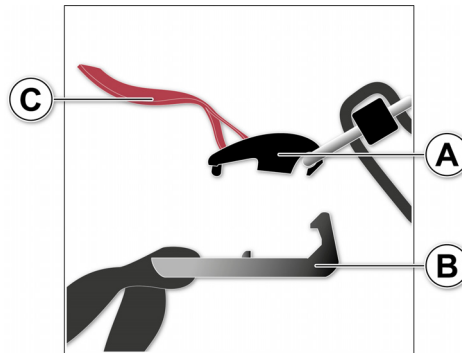

Fig. 6-9 Buckle of the attachment strap

Item	Component	Description
A	Magnetic clip	Part of the buckle of the attachment strap.
B	Magnetic clasp	Part of the buckle of the attachment strap.
C	Red flap	Allows one-handed opening of the buckle.

Tab. 6-6 Buckle of the attachment strap

To form an attachment strap to a hand loop, proceed as follows:



1. Bring the magnetic clasp (item B) and the magnetic clip (item A) towards each other.

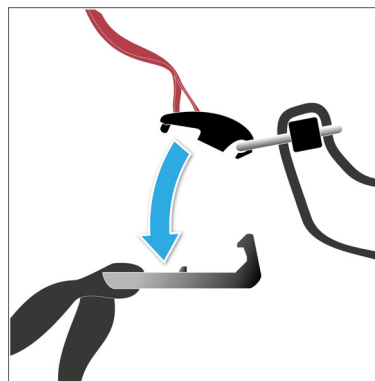

Fig. 6-10 Close the attachment strap to form a hand loop

Both parts of the buckle snap together.

The attachment strap forms a hand loop.



Fig. 6-11 Attachment straps forming hand loops

When using the Scoopboard, make sure to twist the attachment straps once before closing.

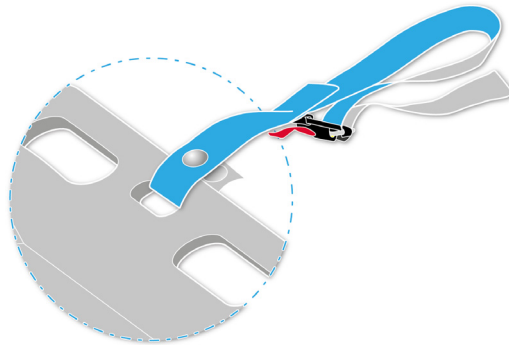

Fig. 6-12 Attachment straps Scoopboard, twisted

6.5.4 Opening the Hand Loops of the Attachment Straps

To open an attachment strap, proceed as follows:



1. Pull on the red flap until the magnetic clip comes loose from the magnetic clasp.

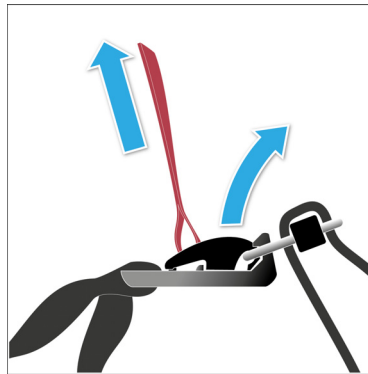

Fig. 6-13 Open attachment strap

Both parts of the buckle are separated from each other.

The attachment strap is open.

7 Operation of the Device

This chapter instructs the user on how to operate the arm.

7.1 Overview of Display and Softkeys

The figure below gives an overview of the display in the **ADVANCED** mode (see 12.4 Usage Selection on page 93) and the softkeys on the support arm.

The four softkeys have different functions depending on the context. The corresponding active functions of the softkeys are represented with symbols on the display. The following figure shows a possible main screen display during therapy.

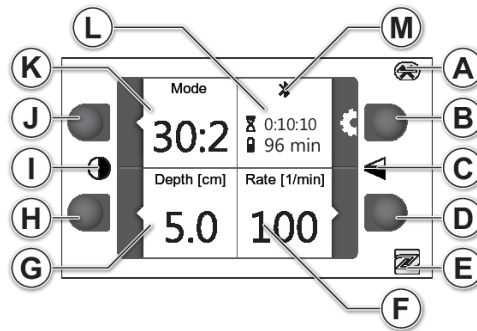







Fig. 7-1 Display and softkeys

Item	Element	Description
A	Symbol 	Indicates the Bluetooth function (see 7.6 Bluetooth on page 46).
B	[Settings] softkey	The following functions are available: <ul style="list-style-type: none"> • Open the "Settings" menu • Confirm the selected settings in all menus
C	Symbol 	Indicates the rotate display function (see 7.4.1 Rotating the Display on page 45).
D	[Pressure frequency] softkey	The following functions are available: <ul style="list-style-type: none"> • Open the "Pressure frequency" menu • Cancel the operation in all menus without saving • Acknowledge alarm messages
E	Symbol 	Indicates the NFC function.
F	Display field "Compression rate"	Shows the configured compression rate in l/min.
G	Display field "Compression depth"	Display of the configured compression depth in cm.
H	[Pressure depth] softkey	The following functions are available: <ul style="list-style-type: none"> • Open the "Pressure depth" menu • Suspending alarm messages • Move the selected line down in all menus
I	Symbol 	Indicates that the function "Invert display" is available (see 7.4.2 Inverting the Display on page 45).
J	[Mode] softkey	The following functions are available: <ul style="list-style-type: none"> • Open the "Mode" menu • Move the selected line up in all menus
K	Display field "Mode"	Display of the active mode.
L	Display field "Info"	The following displays are possible: <ul style="list-style-type: none"> • Display of the current time • Display of the therapy application time • Display of the remaining battery life in min • Display of battery charge level as % during operation with external power source • Display of a suppressed alarm
M	Symbol 	Indicates the current Bluetooth status (see 7.6.6 Checking the Bluetooth Status on page 50).

Tab. 7-1 Display and softkeys

7.2 Main Screen

The main screen consists of these four display fields:

- Display field "Mode"
- Display field "Compression rate"
- Display field "Compression depth"
- Display field "Info"

The contents of the display fields "Mode", "Compression rate" and "Compression depth" correspond to the respective selected therapy settings (see 9.4 Therapy Settings on page 71).

The display field "Info" shows important information.



The display of time and operating time in the "Info" display field changes every 5 s.

7.3 Menu

In the menu, the user can change the settings of the arm.



The settings can only be changed in usage selection mode **ADVANCED** (see 12.4 Usage Selection on page 93).

If the user holds down a softkey for longer than 1 second, quick selection is activated. The user is able to navigate in the menu and change settings faster.



While therapy is in progress, the quick selection function for the depth and rate of compression is deactivated.

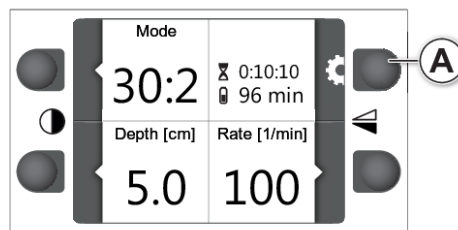

Fig. 7-2 Opening the menu

Item	Element	Description
A	Softkey [Settings]	Allows the menu to be opened.

Tab. 7-2 Opening the menu



If no option is selected after 3 s the display returns to the main screen.

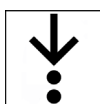

To open the menu, proceed as follows:

1. Press the softkey [Settings].
The screen switches to the menu.

7.3.1 Overview Menu

The following illustration provides an overview of the menu.

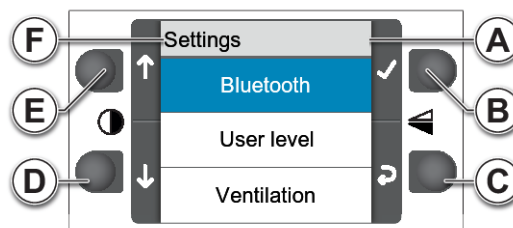

Fig. 7-3 Overview menu (User level DEFAULT-ADVANCED or OPERATOR)

Item	Element	Description
A	<i>Menu item</i>	Menu items can: <ul style="list-style-type: none"> • Open another menu level • Open a configuration dialogue (see 11 Configuration at User Level DEFAULT on page 79).
B	Softkey [OK]	<ul style="list-style-type: none"> • Confirms highlighted menu items • Activates functionalities
C	Softkey [Back]	Back to previous screen without confirmation.
D	Softkey [Down]	Navigating down through the menu.
E	Softkey [Up]	Navigating up through the menu.
F	Menu level	Indicates the current menu level.

Tab. 7-3 Overview menu

7.3.2 Navigating in the Menu

Via the softkeys the user can navigate in the menu.

To navigate in the menu, proceed as follows:



1. Navigate to the menu item using the softkeys [Up] or [Down].
The menu item is highlighted in blue.
2. To select a menu item, press softkey [OK].
Another menu level or a configuration dialogue opens or a functionality is activated.



If the display shows the symbol for the softkey [Back], the user can abort the procedure and return to the former menu.

7.3.3 Confirmation Dialogues

The user has to confirm certain settings before they become active. The following illustration shows the confirmation dialogue "Start update". All other confirmation dialogues offer similar functionality.

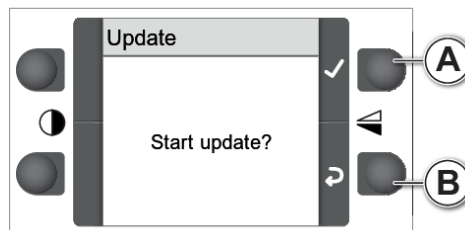
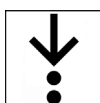

Fig. 7-4 Confirmation dialogue

Item	Element	Description
A	Softkey [OK]	Confirms the selected action.
B	Softkey [Back]	Back to previous screen without confirmation.

Tab. 7-4 Confirmation dialogue

To confirm a selected action, proceed as follows:



1. Press softkey [OK].
The user has confirmed the selected action.
The display shows the previous screen.

7.3.4 Configuration Dialogues

In configuration dialogues, the user can enter values. The following illustration shows the configuration dialogue for LED - Brightness. All other configuration dialogues offer similar functionality.

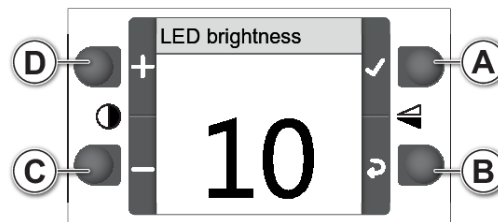
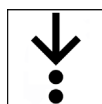

Fig. 7-5 Configuration dialogue

Item	Element	Description
A	Softkey [OK]	Adopting the configured value.
B	Softkey [Back]	Returning to previous screen without adopting the configured value.
C	Softkey [Minus]	Reduces the value.
D	Softkey [Plus]	Increases the value.

Tab. 7-5 Configuration dialogue

To change values in the configuration dialogue, proceed as follows:



1. Adjust the required value with the softkeys [Plus] and [Minus].
2. Press softkey [OK].
The value is changed.
The display shows the previous screen.



The value is not changed permanently. When switched on next time, the corpuls cpr will use the default value (see 10 Factory Settings on page 78).



The value changes immediately, even before the user confirms the required value by pressing the softkey [OK].

7.4 Quick Selection Functions

The quick selection functions allow quick and easy access to certain functions of the arm. The following quick selection functions are available:

- "Rotate display"
- "Invert display"



The quick selection functions "Rotate display" and "Invert display" can be activated from every screen status.

The following illustration describes the quick selection functions using the main screen.

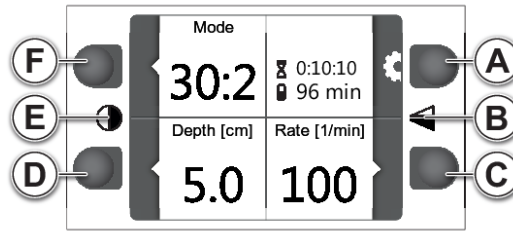

Fig. 7-6 Quick selection functions

Item	Element	Description
A	Softkey [A]	Rotating the display: in combination with softkey [C].
B	Symbol "Rotate display"	Indicates that the function "Rotate display" is available.
C	Softkey [C]	Rotating the display: in combination with softkey [A].
D	Softkey [D]	Inverting the display: in combination with softkey [F].
E	Symbol "Invert display"	Indicates that the function "Invert display" is available.
F	Softkey [F]	Inverting the display: in combination with softkey [D].

Tab. 7-6 Quick selection functions

7.4.1 Rotating the Display

With the quick selection function "Rotate display", the user can rotate the display by 180 °.

To rotate the display, proceed as follows:



1. Press the softkeys [A] and [C] simultaneously.



The assignment of the softkeys for the quick selection function "Rotate display" does not change when the display is rotated. Both softkeys are always above and below the symbol "Rotate display".

7.4.2 Inverting the Display

The quick selection function "Invert display" allows the display to be changed to a dark background.

To activate the quick selection function "Invert display", proceed as follows:



1. Press the softkeys [D] and [F] simultaneously.
The quick selection function "Invert display" has been activated.



The assignment of the softkeys for the quick selection function "Invert display" does not change when the display is rotated. Both softkeys are always above and below the symbol "Invert display".

7.5 Start Screen

At user level OPERATOR, the user can configure two start screens. When starting the arm, these start screens appear one after another (see 12.8 Start Screen on page 96).



In the factory settings, not start screen is configured.

**WARNING!**

Jeopardized therapeutic success due to delayed therapy!

In the usage selection mode BASIC, the user cannot change a wrongly selected patient configuration in the start screen. Changing the patient configuration in the start screen is only possible after switching off the device for 30 s and re-starting the device.

- ▶ Pay close attention when selecting the patient class.

7.5.1 Start Screen Patient

The following illustration shows the start screen "Patient" (see 12.8 Start Screen on page 96).

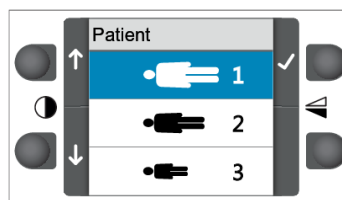

Fig. 7-7 Start screen "Patient"

To select the patient group, proceed as follows:



1. Navigate to the patient symbol using the softkeys [Up] and [Down].
2. Confirm the selection using the softkey [Confirm].

The display shows the main screen or the next configured start screen.

7.5.2 Start Screen Mode

The following illustration shows the start screen "Mode" (see 9.4 Therapy Settings on page 71).

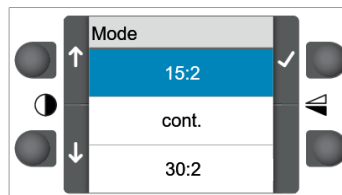

Fig. 7-8 Start screen "Mode"

To select a mode, proceed as follows:



1. Navigate to the mode option using the softkeys [Up] and [Down].
2. Confirm the selection using the softkey [Confirm].

The display shows the main screen.

7.6 Bluetooth

The corpuls cpr can send therapy data wirelessly via Bluetooth to other Bluetooth devices. Based on the therapy data, the user can perform a synchronised therapy with the corpuls cpr and another Bluetooth device.

7.6.1 Limitations

The user can connect **only one** corpuls3 with the corpuls cpr via Bluetooth. Only when the user terminates an existing connection to a corpuls3, the user can connect another corpuls3 to the corpuls cpr.

In general, the user can only connect a maximum of 2 Bluetooth devices simultaneously with the corpuls cpr. A corpuls3 can be one of these Bluetooth devices. If two Bluetooth devices are connected to the corpuls cpr, the user can connect no further devices.

In general, synchronised therapy with a Bluetooth device other than the corpuls3 is possible. At the moment, however, the corpuls3 is the only Bluetooth device that can display therapy data of the corpuls cpr and also control the corpuls cpr.

The paired Bluetooth devices are displayed on the corpuls cpr in the list of paired devices which the user can view via the Bluetooth settings (see Viewing the list of paired devices on page 88). The user can store a maximum of 6 Bluetooth devices in the list of paired devices. If the user is pairing more than 6 devices, the device that was not connected for the longest time will be deleted from the list of paired devices.

7.6.2 Requirements

- A synchronised therapy between the corpuls cpr and corpuls3 is possible as of the following software releases:
 - corpuls cpr (cCPR_1.2.0)
 - corpuls3 (4.0.0)
- The Bluetooth device to be connected has to correspond to the performance- and functionality requirements of Bluetooth Classic of the 2nd version (see Tab. 5-13 Bluetooth on page 135)
- The Bluetooth version on the Bluetooth device to be connected has to be downwards compatible to Bluetooth classic

7.6.3 User of the Bluetooth Interface

The possible actions for users of the Bluetooth interface are different in the user levels.

Possible actions	User level		
	DEFAULT - Basic	DEFAULT - Advanced	OPERATOR
Enable/disable Bluetooth (see Enabling/disabling the Bluetooth function on page 88)		x	x
Enable/disable Bluetooth (see Enabling/disabling the Bluetooth function permanently on page 92) permanently			x
Start Discovery mode (see Pairing and connecting Bluetooth devices via Bluetooth PIN on page 48)	*	*	x
Enable/disable Bluetooth license		**	**
Change Bluetooth PIN (see 12.12 Changing the Bluetooth PIN on page 98)			x

Tab. 7-7 User of the Bluetooth Interface

* If the Bluetooth function is enabled, the user can enable the Discovery mode also in the DEFAULT user level.

** Only the service partner can enable the Bluetooth license. In the user levels DEFAULT-Advanced and OPERATOR, the user can only see the menu entry.

7.6.4 Data Management

The corpuls cpr can transfer mission data via Bluetooth to other Bluetooth devices. The corpuls cpr transfers the mission data continuously during the mission.

The data transmission is prerequisite for the synchronised therapy with the corpuls3 (see 9.9 Synchronised Therapy with corpuls3 on page 77).

Prerequisite:

- The authorised sales and service partner has enabled the Bluetooth license.
- The corpuls cpr is paired with the Bluetooth device (see 7.6.5 Pairing and Connecting Bluetooth Devices on page 48)

If the corpuls cpr transfers mission data to the Bluetooth device, the display shows the symbol  (see 7.6.6 Checking the Bluetooth Status on page 50). If the corpuls cpr is switched off during data transmission, data transmission will be aborted. Therefore, the manufacturer recommends to keep the corpuls cpr switched on during data transmission.



Mission data will not be deleted after a data transmission and are still available on the SD card.

7.6.5 Pairing and Connecting Bluetooth Devices

Pairing means the first contact between two Bluetooth devices. The user can only establish a Bluetooth connection to the corpuls cpr with already paired Bluetooth devices.

The manufacturer recommends to pair the corpuls cpr and the Bluetooth device before the mission. If the user is unable to pair the corpuls cpr and the Bluetooth device before the mission, the user can pair two Bluetooth devices during the mission as well.



The user must change the Bluetooth PIN before first commissioning the corpuls cpr and thus also before pairing (see 12.12 Changing the Bluetooth PIN on page 98) (see 3.2 Cyber Security on page 12).

There are two options to establish a Bluetooth connection to a Bluetooth device:

- Pairing and connecting Bluetooth devices via the Bluetooth PIN (see Pairing and connecting Bluetooth devices via Bluetooth PIN on page 48)
- Connecting Bluetooth devices after pairing without Bluetooth PIN (see Connecting Bluetooth devices after pairing without Bluetooth PIN on page 49)

Pairing and connecting Bluetooth devices via Bluetooth PIN

The user can pair and connect the corpuls cpr with a Bluetooth device via the Bluetooth PIN. In the following, the procedure how to pair the corpuls3 with another Bluetooth device is shown by the example of the corpuls cpr.

To pair and connect the corpuls cpr via the Bluetooth PIN with a Bluetooth device, proceed as follows:



Prerequisite:

- ✓ The user has permanently enabled the Bluetooth function at user level OPERATOR (see Enabling/disabling the Bluetooth function permanently on page 92)
- ✓ The Bluetooth PIN is available (see 11.4.1 Info on page 84)
- ✓ The Bluetooth device to be paired has Bluetooth function
- ✓ The user has enabled the Bluetooth data interface for the corpuls3 at user level OPERATOR (see user manual corpuls3)
- ✓ The user must have read and understood the information pertaining to Bluetooth and pairing in user manual of the device to be paired

1. Navigate with the softkeys [Up] and [Down] to the menu item *Bluetooth*.

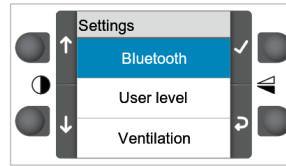



Fig. 7-9 Menu item Bluetooth

2. Activate the selection using the [Confirm] softkey.
The corpuls cpr switches to discovery mode: The Bluetooth symbol  flashes for 2 min on the main screen. For 2 min, other Bluetooth devices can find the corpuls cpr and pair with the corpuls cpr.
3. On the corpuls3, select *Bluetooth > Connect* in the main menu and press the softkey [Scan].
The corpuls3 searches for all Bluetooth devices in discovery mode and lists these with their MAC addresses.

The Bluetooth device to be connected has to be within reach (typically < 10 m) of the corpuls cpr.



4. On the corpuls3 confirm the listed corpuls cpr.
5. Enter the Bluetooth PIN on the corpuls3 and confirm.
The corpuls cpr and the corpuls3 are paired and are establishing a Bluetooth connection.
On the corpuls3, the message <BT connected: „Device“> appears.
The main screen of the corpuls cpr shows the symbol  permanently (see Tab. 7-8 Bluetooth status on page 50).



The paired Bluetooth device appears with its MAC address in the list of paired devices of the corpuls cpr (see Viewing the list of paired devices on page 88).



If the user pairs the corpuls cpr with a corpuls3, the corpuls cpr appears with its MAC address on the corpuls3 in the main menu *Bluetooth > Connections* in the overview of Bluetooth connections. If the user is logged in on the corpuls3 as OPERATOR, the configuration can be stored via the main menu *System > Settings* and store the corpuls cpr permanently in the overview of Bluetooth connections. Otherwise, after switching the corpuls3 off and on again, the corpuls cpr will be deleted from the overview of Bluetooth connections.



Alternatively, the user can also enter the MAC address and the Bluetooth PIN manually in the main menu *Bluetooth > Connections > Add destination* and pair the corpuls3 with the corpuls cpr (see user manual corpuls3).

Connecting Bluetooth devices after pairing without Bluetooth PIN

If the user pairs the corpuls cpr with a Bluetooth device, a Bluetooth connection can be established via the paired Bluetooth device without entering the Bluetooth PIN again. In the following, the procedure how to pair the corpuls3 with an already paired Bluetooth device is shown by the example of the corpuls cpr.

To connect Bluetooth devices after pairing without Bluetooth PIN, proceed as follows:



- ✓ The corpuls cpr and the corpuls3 are paired (see Pairing and connecting Bluetooth devices via Bluetooth PIN on page 48) and the user, logged in as OPERATOR on the corpuls3, has stored the configuration after pairing.
- ✓ The user has permanently enabled the Bluetooth function at user level OPERATOR (see Enabling/disabling the Bluetooth function permanently on page 92)
- ✓ The user has enabled the Bluetooth data interface for the corpuls3 at user level OPERATOR (see user manual corpuls3)

1. On the corpuls3 , select in the main menu *Bluetooth > Connections*.
The overview of Bluetooth connections appears on the corpuls3 .
2. Select the already paired corpuls cpr and confirm.
The corpuls cpr and the corpuls3 are establishing a Bluetooth connection.
On the corpuls3 , the message <BT connected: „Device“> appears.
The main screen of the corpuls cpr shows the symbol  permanently (see 7.6.6 Checking the Bluetooth Status on page 50).







Alternatively, the user can establish the Bluetooth connection from a corpuls3 in defibrillation mode via the softkey [Connect], if the user has enabled the option Quick select in the Bluetooth settings of the corpuls3 (see user manual corpuls3).

7.6.6 Checking the Bluetooth Status

The user can check the Bluetooth status via the main screen.

The following table shows the possible statuses:

Symbol	Description	Status
	No Bluetooth symbol	<ul style="list-style-type: none"> • There is no Bluetooth connection
	Flashing Bluetooth symbol	<ul style="list-style-type: none"> • Bluetooth in Discovery mode • corpuls cpr is visible for other devices
	Permanent Bluetooth symbol with number 1	<ul style="list-style-type: none"> • There is a Bluetooth connection to a Bluetooth device
	Permanent Bluetooth symbol with number 2	<ul style="list-style-type: none"> • There is a Bluetooth connection to two Bluetooth devices
	Permanent Bluetooth symbol with arrows	<ul style="list-style-type: none"> • Bluetooth connection with data transmission of larger amounts of data (e.g.mission data)
	Permanent greyed out Bluetooth symbol with "X"	<ul style="list-style-type: none"> • Bluetooth connection not possible for technical reasons.

Tab. 7-8 Bluetooth status

7.6.7 Connection lost



CAUTION!

Loss of Bluetooth connection!

Can result in therapy delay during synchronised therapy.

- ▶ Supervise the device during therapy.
- ▶ Intervene in case of error and re-establish the Bluetooth connection.

If the Bluetooth connection between a corpuls cpr and a corpuls3 is interrupted during synchronised therapy, the arm issues a high priority alarm (see High priority alarms on page 54). The current action is continued (compression or no compression) . When the connection is established again, the alarm ends.

7.6.8 Terminating the Bluetooth Connection

The user has three options to terminate a Bluetooth connection:

- Terminating the Bluetooth connection at the corpuls3
- Terminating the Bluetooth connection at the corpuls cpr (see Enabling/disabling the Bluetooth function on page 88)
- Switching off the corpuls cpr (see 9.6 Switching Off the Arm on page 75)



The manufacturer recommends terminating the Bluetooth connection at the corpuls3. If the user switches off the corpuls cpr, the corpuls3 keeps trying to establish a connection. In this case, the corpuls3 cannot find the corpuls cpr. An alarm message appears on the corpuls3.



To terminate the Bluetooth connection at the corpuls3, proceed as follows:

1. With the jog dial, select in the main menu *Bluetooth > Disconnect*.

If several Bluetooth devices are connected, a configuration dialogue with a list of Bluetooth devices appears. The user has to select the device to be disconnected.

Bluetooth connection is terminated

On the corpuls3, the message <BT disconnected: „Device“> appears.

The main screen of the corpuls cpr shows no longer the symbol .

8 Alarms

This chapter instructs the user about the alarms for the arm and the battery.

8.1 Alarm Design

The alarm line on the display and the LED of the **Start/Stop** key illustrate the alarm priorities visually using different colours (see 8 Alarms on page 52). Acoustically, the alarm generator indicates alarm priorities using different tone sequences. The user can suspend the alarms and undo the suspension. The LED and the alarm generator remind the user that the alarm suspension function is active. For this purpose, the LED flashes once every 60 s, and the alarm generator emits an acoustic signal.

8.2 Warnings

The following warnings inform the user of possible hazards for this chapter.



WARNING!

Jeopardized therapeutic success by not eliminating alarms!

If alarms with a high priority are not eliminated, this can lead to failure of the arm and subsequently to aborted therapy.

- ▶ Eliminate high priority alarms immediately after their occurrence.



If the display and the LEDs fail while the device is switched on, the alarm messages (see 8.3 Alarms and Messages on the Arm on page 52) can only be signalled acoustically. If the device does no longer react to actions of the user, the intended use is no longer guaranteed. In this case, the user has to perform manual CPR immediately and then contact an authorised sales and service partner.



If the arm fails completely, no alarm messages can be issued at all to inform the user of the failure. This requires from the user a heightened awareness for the device functioning as intended. If the arm fails completely, the user has to perform manual CPR immediately and then contact an authorised sales and service partner.

8.3 Alarms and Messages on the Arm

The arm signals alarms in three ways:

- Visually via the LED of the **Start/Stop**key (see 5.2 Components of the Arm on page 21)
- Visually via the alarm line on the display (see 7.1 Overview of Display and Softkeys on page 40)
- Acoustically via the speakers of the alarm generator



During an alarm, the user cannot change settings of the arm. This is also true for suspended alarms. Only the quick selection functions "Rotate display" and "Invert display" are always possible.



The alarm line of the display shows the alarm symbol as well as the alarm ID. This ID allows customer service to determine the exact cause of the alarm.



In case of medium priority alarms, the therapy can be continued (see Tab. 8-2 Medium priority alarms on page 57).

8.3.1 Priorities of the Alarms

The alarm line of the display and the LED of the **Start/Stop** key always show the active alarm with the highest priority. The background colour of the alarm line and the colour of the LED of the **Start/Stop** key correspond to the priority of the alarm signal.

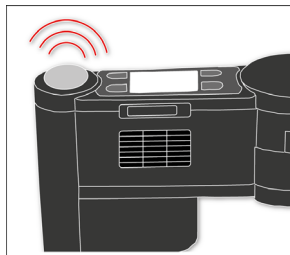

Fig. 8-1 LED of the start/stop key

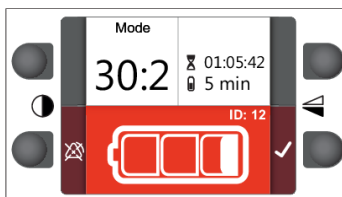











Fig. 8-2 Display with active alarm line

The following tables show all alarms of the arm and describe:

- The symbols used
- The causes of the fault
- The possible consequences
- The measures to be taken to eliminate the fault

High priority alarms

Symbol	Cause	Consequences	Measure
	System error	<ul style="list-style-type: none"> Injury of the patient possible Alarm failure Sensor failure Therapy failure 	<ul style="list-style-type: none"> Switch off the arm* (see 9.6 Switching Off the Arm on page 75) Continue CPR manually without the corpuls cpr Contact customer service <p>During the power-down procedure, the alarm symbol appears again as a message.</p>
	Malfunction	<ul style="list-style-type: none"> False data shown in display Functional error Overheating 	<ul style="list-style-type: none"> Switch off the arm (see 9.6 Switching Off the Arm on page 75) Continue CPR manually without the corpuls cpr Contact customer service <p>During the power-down procedure, the alarm symbol appears again as a message.</p>
	Therapy stopped for longer than 8 s	<ul style="list-style-type: none"> No therapy performed on the patient 	<ul style="list-style-type: none"> Continue therapy with the corpuls cpr (see 9.5.2 Starting, Stopping/Pausing and Resuming Therapy on page 74) Confirm the alarm (see 8.3.2 Alarm Confirmation and Alarm Suspension on page 58) Or continue CPR manually without the corpuls cpr
	Battery charging status very low	<ul style="list-style-type: none"> Imminent failure of the arm 	<ul style="list-style-type: none"> Insert fully charged reserve battery (see 6.2.3 Changing the Battery on page 34) Or continue CPR manually without the corpuls cpr
	Battery not ready for use	<ul style="list-style-type: none"> Arm not operational 	<ul style="list-style-type: none"> Insert fully charged reserve battery (see 6.2.3 Changing the Battery on page 34) Or continue CPR manually without the corpuls cpr
	The locking lever was not initially opened after the arm was switched on	<ul style="list-style-type: none"> Therapy not possible 	<ul style="list-style-type: none"> Open the locking lever Adjust the arm and set the therapy position Close the locking lever Start therapy
	Locking lever not closed	<ul style="list-style-type: none"> Therapy not possible 	<ul style="list-style-type: none"> Close the locking lever







Symbol	Cause	Consequences	Measure
	Arm set too low	<ul style="list-style-type: none"> Therapy not possible 	<ul style="list-style-type: none"> Raise the arm (see 9.3.5 Adjusting the Arm on page 69) Observe the stamp position check (see 9.3.6 Stamp Position Check on page 70)
	Temperature of the arm very high	<ul style="list-style-type: none"> Arm temperature exceeds specifications Imminent failure of the arm 	<ul style="list-style-type: none"> If necessary, continue CPR manually without the corpuls cpr <p>During the power-down procedure, the alarm symbol appears again as a message.</p>
	Connection to corpuls3 lost	<ul style="list-style-type: none"> Synchronised mode not possible or only limited 	<ul style="list-style-type: none"> If necessary, start or stop therapy directly at the corpuls cpr





Tab. 8-1 High priority alarms



* If the arm cannot be switched off in an emergency, remove the battery (see 6.2.3 Changing the Battery on page 34).





Medium priority alarms

Symbol	Cause	Consequences	Measure
	Battery charging status low	<ul style="list-style-type: none"> Imminent failure of the arm 	<ul style="list-style-type: none"> Insert fully charged reserve battery (see 6.2.3 Changing the Battery on page 34)
	The maximum life span of the battery has been reached	<ul style="list-style-type: none"> The technical specifications of the battery are no longer ensured (see V Technical Specifications on page 129) 	<ul style="list-style-type: none"> Insert fully charged reserve battery (see 6.2.3 Changing the Battery on page 34) Or continue CPR manually without the corpuls cpr Obtain a new reserve battery <p>During the power-down procedure, the alarm symbol appears as a message.</p>
	Faulty battery	<ul style="list-style-type: none"> The technical specifications of the battery are no longer ensured (see V Technical Specifications on page 129) 	<ul style="list-style-type: none"> Insert fully charged reserve battery (see 6.2.3 Changing the Battery on page 34) Contact customer service During the power-down procedure, the alarm symbol appears as a message
	Self-test when starting the arm failed	<ul style="list-style-type: none"> The technical specifications of the arm are no longer ensured (see V Technical Specifications on page 129) Therapy might be started with deviations from the technical specification 	<ul style="list-style-type: none"> Contact customer service
	Invalid date/time	<ul style="list-style-type: none"> Response logs with incorrect date / incorrect time 	<ul style="list-style-type: none"> Set the date and time (see 11.4.6 Date on page 87) (see 11.4.5 Time on page 86) Contact customer service, if necessary
	Therapy stopped	<ul style="list-style-type: none"> No therapy performed on the patient After 8 s, the alarm escalates to a high priority alarm 	<ul style="list-style-type: none"> Continue therapy with the corpuls cpr (see 9.5.2 Starting, Stopping/Pausing and Resuming Therapy on page 74) Continue therapy with the corpuls cpr (see 8.3.2 Alarm Confirmation and Alarm Suspension on page 58) Or continue CPR manually without the corpuls cpr

Symbol	Cause	Consequences	Measure
	Arm too high	<ul style="list-style-type: none"> Set compression depth not ensured Inadequate therapy 	<ul style="list-style-type: none"> Adjust the arm lower (see 9.3.5 Adjusting the Arm on page 69)
	Arm too low	<ul style="list-style-type: none"> Full release of the thorax not ensured Inadequate therapy 	<ul style="list-style-type: none"> Adjust the arm higher (see 9.3.5 Adjusting the Arm on page 69) Check moveability of the stamp
	Temperature of the arm high	<ul style="list-style-type: none"> The specification limits of the arm might be reached 	<ul style="list-style-type: none"> If necessary, adjust the compression depth and compression rate If necessary, continue CPR manually without the corpuls cpr
	Overload	<ul style="list-style-type: none"> Overloading the arm possible 	<ul style="list-style-type: none"> Perform stamp position check If necessary, re-adjust the arm Confirm the alarm, if the settings are correct (e.g. in case the thorax rigidity of the patient is higher than normal)

Tab. 8-2 Medium priority alarms

Low Priority Alarms

Symbol in the display	Cause	Consequences	Measure
	Read or write error of the SD card	<ul style="list-style-type: none"> SD card cannot be used 	<ul style="list-style-type: none"> Check SD card Or replace SD card <p>During the power-down procedure, the alarm symbol appears again as a message.</p>
	Free memory <20 %	<ul style="list-style-type: none"> Remaining memory on SD card is low 	<ul style="list-style-type: none"> Replace SD card Or delete data from the SD card <p>During the power-down procedure, the alarm symbol appears again as a message.</p>
	SD card full	<ul style="list-style-type: none"> No space remaining on SD card 	<ul style="list-style-type: none"> Replace SD card Or delete data from the SD card <p>During the power-down procedure, the alarm symbol appears again as a message.</p>
	Battery cannot be charged	<ul style="list-style-type: none"> Full capacity of the battery cannot be guaranteed Failure of the power supply possible 	<ul style="list-style-type: none"> Insert fully charged reserve battery (see 6.2.3 Changing the Battery on page 34)

Tab. 8-3 Low priority alarms

8.3.2 Alarm Confirmation and Alarm Suspension

To terminate alarms, the user has to confirm the alarm messages.

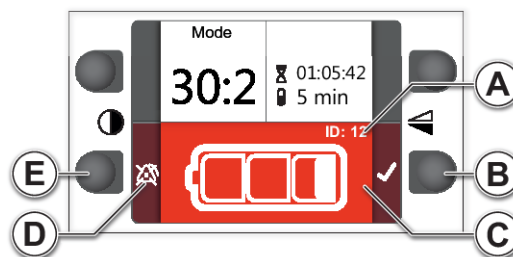



Fig. 8-3 Alarms display

Item	Element	Description
A	Alarm ID	Identifies the cause of the alarm.
B	[Acknowledge alarm] softkey	Confirms the audiovisual alarm message.
C	Alarm line	Displays the reported alarm and additional information.
D	Switch on alarm suppression symbol	Indicates the "Switch on alarm suppression" function.
	Switch off alarm suppression symbol	Indicates the "Switch off alarm suppression" function.
E	[Switch on alarm suppression] softkey	Suspends the audiovisual alarm message.
	[Switch off alarm suppression] softkey	Enables the audio-visual alarm message after suspension.

Tab. 8-4 Alarms display

Optionally, the user can suspend the alarms for a maximum of 120 s (see Activating alarm suspension on page 59). The display shows the symbol  in the display field "Info" (see 7.1 Overview of Display and Softkeys on page 40) and next to the symbol.

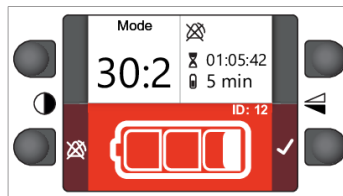

Fig. 8-4 Alarms suppressed



When alarm suppression is activated, the arm does not issue audio-visual alarms for the set period of time. The alarm line of the display continues to show alarms.

Alarm Confirmation

Alarm confirmation ends the alarm message. If there are new alarm conditions, the arm signals new alarms.

To confirm the alarm message, proceed as follows:



Prerequisite:

- ✓ The arm issues an alarm

1. Press softkey [Confirm alarm].

The user has confirmed the alarm message. The arm ends alarm message output.

Activating alarm suspension

Alarm suspension ends the alarm message. The arm does not signal any further alarms during the configured alarm suspension interval (see 11.4.7 Audiovisual Signals on page 87).

To enable alarm suspension, proceed as follows:



Prerequisite:

- ✓ The arm issues an alarm

1. Press the softkey [Activating alarm suspension] for 3 s.

The user has enabled the alarm suspension. An audiovisual signal reminds the user at regular intervals of suspended alarms. The display shows the symbol  in the display field "Info" and next to the softkey.



If the user only suspends an alarm and does not confirm it, the alarm is still active. The user cannot change settings.

Deactivating alarm suspension

The alarm suspension can be disabled again. The current alarm and all future alarms will again be signalled audiovisually.

To disable the alarm suspension, proceed as follows:





Prerequisite:

- ✓ The alarm suspension is enabled

1. Press the softkey [Deactivating alarm suspension] for 3 s.

The user has disabled the alarm suspension. The display shows the symbol  next to the softkey.







8.3.3 Notes

Representation/symbol on the display	Cause	Consequences	Measure
Blue signal of the LED on the Start/Stop key	Ventilation pause	<ul style="list-style-type: none"> • Notice concerning the ventilation of the patient 	<ul style="list-style-type: none"> • Ventilate patient
	Service checkup is due	<ul style="list-style-type: none"> • None 	<ul style="list-style-type: none"> • Contact customer service <p>During the power-down procedure, the symbol appears as a message.</p>
	Customer service for battery	<ul style="list-style-type: none"> • None 	<ul style="list-style-type: none"> • Use the reserve battery for the next mission • Contact customer service <p>During the power-down procedure, the symbol appears as a message.</p>

Tab. 8-5 Notes

8.3.4 LED of the Start/Stop Key

The following table shows all the possible colours of the LED of the Start/Stop key as well as what they can mean.

Symbol	Designation	Meaning
	Red LED	Possible meaning: <ul style="list-style-type: none"> • High priority alarm (see High priority alarms on page 54) • Arm too low (see 9.3.6 Stamp Position Check on page 70)
	Yellow LED	Possible meaning: <ul style="list-style-type: none"> • Medium priority alarm (see Medium priority alarms on page 56) • Arm too high (see 9.3.6 Stamp Position Check on page 70)
	Cyan LED	<ul style="list-style-type: none"> • Low priority alarm (see Low Priority Alarms on page 58)
	White LED	Possible meaning: <ul style="list-style-type: none"> • Self-test passed (see 16.3 Selftest on page 114) • corpuls cpr has been found by another device (Bluetooth) • Alarm suspension enabled (see 8.3.2 Alarm Confirmation and Alarm Suspension on page 58) • The arm is being switched off (see 9.6 Switching Off the Arm on page 75)
	Blue LED	<ul style="list-style-type: none"> • Ventilation signal (see 11.4.7 Audiovisual Signals on page 87)
	Green LED	<ul style="list-style-type: none"> • Optimum stamp position (see 9.3.6 Stamp Position Check on page 70)

Tab. 8-6 LED of the Start/Stop key

8.3.5 Messages at Switch Off

During the power-down procedure, the arm repeats signalling of certain alarms that occurred during operation as audiovisual messages:

- <Temperature of the arm too high>
- <The maximum life span of the battery has been reached>
- <Battery defective>
- <Read and write error of the SD card>
- <Free memory on the SD card <20 %>
- <SD card full>
- <Service due>

This message only appears during the power-down procedure and not during ongoing operation.

- <Customer service for battery>

This message only appears during the power-down procedure and not during ongoing operation.

The display shows each of these messages for 3 s before the arm switches off. If there are several messages, the display shows these messages one after another.



The user can confirm these messages.

8.4 Battery Alarms

The battery indicates different alarms via flashing LEDs.

If two alarm conditions exist, the battery always indicates the oldest alarm. The battery only indicates the alarm once automatically. The current alarm must then be retrieved by pressing the **Charging status** key.

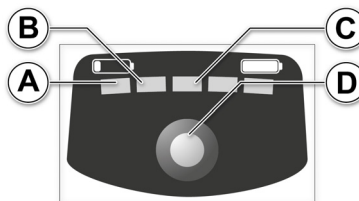

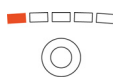







Fig. 8-5 Battery keypad with battery display

Item	Component	Properties
A	LED 1	The following statuses are possible: <ul style="list-style-type: none"> • Off • Orange • Green
B	LED 2	The following statuses are possible: <ul style="list-style-type: none"> • Off • Green
C	LED 3	The following statuses are possible: <ul style="list-style-type: none"> • Off • Green
D	Key Charging status	The following functions are available: <ul style="list-style-type: none"> • Activates the charging status (see 6.2.1 Battery Charging Status on page 32) • Activates the alarm indication

Tab. 8-7 LEDs of the battery display

The following table shows all alarms of the battery and describes:

- The statuses of the LEDs
- The causes of the fault
- The possible consequences
- The measures to be taken to eliminate the fault

Status of the LEDs	Cause	Consequences	Measure
	Battery empty	<ul style="list-style-type: none"> Imminent failure of the arm 	<ul style="list-style-type: none"> Insert fully charged reserve battery (see 6.2.3 Changing the Battery on page 34) Or connect the arm to a power supply (see 6.2.2 Charging the Battery on page 33)
	Battery too cold	<ul style="list-style-type: none"> Battery switches off Starting the arm is not possible 	<ul style="list-style-type: none"> Warm up the battery Or insert a warmed-up and fully charged reserve battery (see 6.2.3 Changing the Battery on page 34) <p>When the battery has warmed up sufficiently, it switches on again automatically. If the battery is inserted in an arm in this case, the arm switches itself on automatically.</p>
	Battery too hot	<ul style="list-style-type: none"> Battery switches off Starting the arm is not possible 	<ul style="list-style-type: none"> Cool down the battery Or insert a colder and fully charged reserve battery (see 6.2.3 Changing the Battery on page 34) <p>When the battery has cooled down sufficiently, it switches on again automatically. If the battery is inserted in an arm in this case, the arm switches itself on automatically.</p>
	Battery voltage too low	<ul style="list-style-type: none"> Battery switches off 	<ul style="list-style-type: none"> Insert fully charged reserve battery (see 6.2.3 Changing the Battery on page 34) Or continue CPR manually without the corpuls cpr <p>The battery will take longer to achieve a battery charge status of 100 % as the voltage is too low (see 6.2.1 Battery Charging Status on page 32).</p>
	Battery voltage too high	<ul style="list-style-type: none"> The battery switches off permanently Starting the arm is not possible 	<ul style="list-style-type: none"> Insert fully charged reserve battery (see 6.2.3 Changing the Battery on page 34) Contact customer service
  	Excess current during discharge	<ul style="list-style-type: none"> Battery switches off Starting the arm is not possible 	<ul style="list-style-type: none"> Check contacts Insert fully charged reserve battery (see 6.2.3 Changing the Battery on page 34) Contact customer service

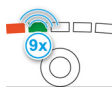
Status of the LEDs	Cause	Consequences	Measure
	Excess current during charging	<ul style="list-style-type: none"> Battery switches off Starting the arm is not possible 	<ul style="list-style-type: none"> Remove the AC adapter Insert fully charged reserve battery (see 6.2.3 Changing the Battery on page 34) Or continue CPR manually without the corpuls cpr Contact customer service
	Critical error	<ul style="list-style-type: none"> The battery switches off permanently Starting the arm is not possible 	<ul style="list-style-type: none"> Insert fully charged reserve battery (see 6.2.3 Changing the Battery on page 34) Contact customer service

Tab. 8-8 Battery alarms

9 Therapy

The corpuls cpr allows to perform electromechanical thorax compressions.

9.1 Warnings

The following warnings inform the user of possible hazards for this chapter.



DANGER!

Cardiovascular arrest due to aborted therapy!

Leads to organ failure of the patient.

- ▶ Avoid interruption of therapy.
- ▶ Reduce the time without therapy to a minimum.



DANGER!

Overheating due to heat accumulation!

Leads to a breakdown of the arm and, due to aborted therapy, subsequent organ failure of the patient.

- ▶ Do not cover the ventilation slots for air intake and -outlet.
- ▶ Keep the ventilation slots for air intake and -outlet clean.



CAUTION!

Neglect of supervisory duty during therapy!

Can lead to injuries of the patient.

- ▶ Supervise the device during therapy.
- ▶ In case of error stop device and continue therapy manually.



CAUTION!

Therapy without stamp!

Can lead to patient injury in the thorax area.

- ▶ Always use a stamp for the therapy.



CAUTION!

Body parts in the therapy zone!

Can lead to patient or user injury.

- ▶ Keep parts of the body away from the stamp while therapy is in progress.



CAUTION!

Defibrillation during therapy!

Can lead to injuries of the patient.

- ▶ Pause therapy for defibrillation or use the synchronised mode with the corpuls3 .



Thorax compressions impair ECG analysis. Briefly pause therapy for the duration of the ECG analysis (see 9.5 Performing Therapy on page 73). Nevertheless, reduce the time without therapy to a minimum.

i The quality of the resuscitation procedure has to be rated with available means, e.g. monitoring. If necessary, adjust the therapy settings or continue resuscitation manually.

9.2 Arrival at the Patient

If cardiac arrest is suspected, immediately start manual cardio-pulmonary resuscitation (CPR). While one assistant is preparing therapy with corpuls cpr, continue manual CPR without interruption.

9.3 Preparing Therapy

To begin therapy, the user must prepare the patient and the corpuls cpr. The following section describes the preparation of therapy using the Quadboard as an example (see 5.5.11 Quadboard on page 30).

Therapy preparation is performed in the same way with the Recboard (see 5.5.7 Recboard on page 28).

9.3.1 Preparing the Patient

To begin therapy, the user must place the board beneath the patient.

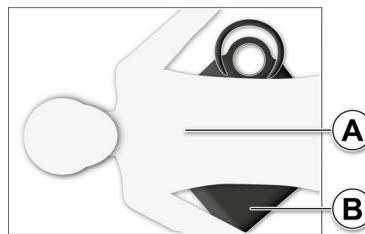

Fig. 9-1 Placing the Quadboard beneath the patient

Item	Element	Description
A	Therapy zone	Body region of the patient where therapy is to be performed: <ul style="list-style-type: none"> On the lower third of the sternum
B	Quadboard	Board for therapy with the arm.

Tab. 9-1 Placing the Quadboard beneath the patient

i Refer to the respective guidelines for the correct definition of the therapy zone for CPR. The latest version is available at www.cprguidelines.eu.

To place the Quadboard beneath the patient, proceed as follows:



1. Slide the Quadboard beneath the patient's back.

i In doing so, ensure that the Quadboard socket for the arm is not obstructed.

The Quadboard is placed beneath the patient.

i Remove all items of clothing and jewellery from the thorax area of the patient.

i Remove existing CPR feedback sensors from the patient's body.

i The manufacturer recommends to position the Quadboard in such a way that the socket for the corpuls cpr arm is located besides the patient. If necessary, the socket may also be located besides the head of the patient.

9.3.2 Checking the Stamp Size

Before starting therapy, the user has to check if the correct size of the stamp is inserted in the arm.



It is the responsibility of the user to select a stamp of the correct size (see 5.3 Stamp on page 22). The manufacturer recommends to use the corpuls cpr stamp (long) for children aged 8 years or older.

9.3.3 Assembling the Arm

The user must assemble the arm on one of the therapy boards of the corpuls cpr. The assembly procedure depends on the type of board.



WARNING!

Damaged equipment due to incorrect assembly of the arm!

Can lead to damage of important or life-saving equipment and to life-threatening patient injury.

- Ensure that no equipment, such as e.g. IV lines, is located between the bayonet lock and the socket of the board during assembly of the arm.



CAUTION!

Risk of crush injuries during assembly of the arm!

Can lead to crush injuries of the patient or the user during assembly of the arm.

- Make sure that no body parts are trapped between the bayonet lock and the therapy board socket.



CAUTION!

Risk of crush injuries!

Can lead to crush injuries in the thorax area of the patient during assembly of the arm.

- Adjust the arm during assembly in such a way that the stamp column is located beside the patient's body.

NOTICE!

Damage due to tilting!

When a load is not applied (no patient weight), the board with the assembled arm can tilt over and damage the corpuls cpr and its accessories.

- Do not transport the corpuls cpr before it has been assembled. When assembling without a patient, place a load on the board used, e.g. in case of the daily functional test.

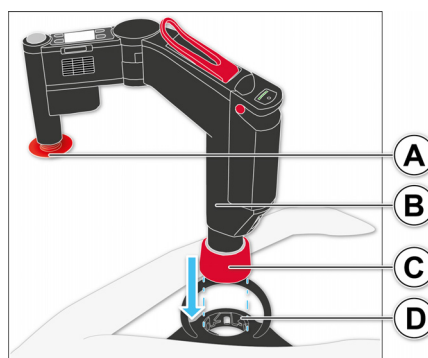

Fig. 9-2 Assembling the arm

Item	Element	Description
A	Stamp column	Telescopic column for holding the stamp.
B	Arm	The arm is the central electromechanical unit for therapy.
C	Bayonet lock	Allows the arm to be assembled on one of the therapy boards.
D	Socket	Counterpart component for the Bayonet lock for assembling the arm on a therapy board.

Tab. 9-2 Assembling the arm

To assemble the arm, proceed as follows:



1. Position the arm at the side of the patient.



The stamp must be located beside the patient's body during assembly.

2. Open the bayonet lock by turning and hold.
3. Insert the arm from above with slight pressure into the Quadboard socket.
4. Close the bayonet lock.

The arm is securely assembled on the Quadboard.



The user is responsible for checking if the arm is assembled correctly.

9.3.4 Switching On the Arm

To minimise the time without therapy, switch on the arm as soon as possible.

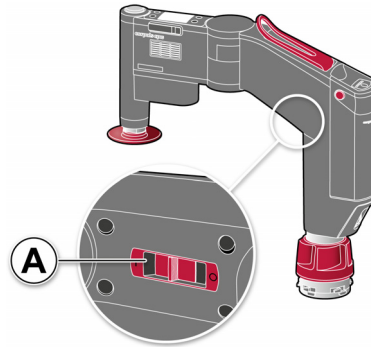

Fig. 9-3 Switching on the arm

Item	Component	Description
A	On/Off switch	Switches the arm on and off.

Tab. 9-3 Switching on the arm

To switch on the arm, proceed as follows:



Prerequisite:

- ✓ The arm is switched off (see 9.6 Switching Off the Arm on page 75)
- ✓ A fully charged battery is inserted (see 6.2.3 Changing the Battery on page 34)

1. Push the **On/Off** switch at the underside of the arm to the "On" position.

The arm performs a self-test.



During the self-test, the LED of the **Start/Stop** key briefly flashes white and emits an acoustic signal. If the self-test of the arm is not successful, the display shows corresponding messages (see 8 Alarms on page 52).

The main screen (see 7.2 Main Screen on page 41) or a start screen (see 7.5 Start Screen on page 45) appears.



Once the arm has been switched on, the additional symbol  is shown at the centre of the main screen that prompts the user to open the locking lever and adjust the arm. Therapy is not yet possible.

9.3.5 Adjusting the Arm

To begin therapy, the user must position the arm above the patient. The arm can be adjusted in height, pivoted vertically, and further adjusted in the joint.

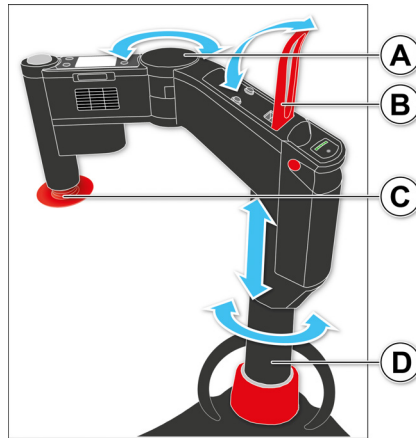

Fig. 9-4 Adjusting the arm

Item	Element	Description
A	Joint	Allows the arm to be swivelled to the left or to the right.
B	Locking lever	The following functions are available: <ul style="list-style-type: none"> • Immobilisation of the arm at the joint and lifting column • Releasing the patient
C	Stamp	Allows transfer of compression from the arm to the thorax of the patient.
D	Lifting column	Telescopic column for adjusting the arm.

Tab. 9-4 Adjusting the arm

To position the arm above the patient, proceed as follows:



1. Release the locking lever.



In order to prevent unintentional opening of the locking lever, a certain amount of force is required for opening.

The joint is unlocked. The user can freely rotate the arm and adjust its height.
The stamp position check is active (see 9.3.6 Stamp Position Check on page 70).

2. Adjust the stamp in the therapy zone of the patient.

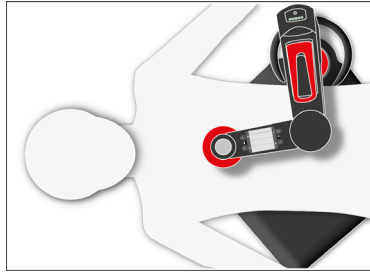

Fig. 9-5 Adjusting the arm in the therapy zone

3. Adjust the height of the arm.
4. Place the stamp on the thorax in accordance with the stamp position check (see 9.3.6 Stamp Position Check on page 70).
5. Close the locking lever.

The arm is adjusted over the sternum of the patient and immobilised.



Choose the pressure point of the stamp in accordance with the guidelines for CPR.



Therapy can only be started once initial opening of the locking lever has been carried out in order to adjust the arm.



Therapy cannot begin until the locking lever has been closed.



The user is responsible for checking if the locking lever is closed correctly.







The user is responsible for regularly checking the correct position of the stamp.

9.3.6 Stamp Position Check

If the user adjusts the arm too high or too low, either full release of the thorax or optimum compression depth cannot be achieved. The stamp position check provides the user with information as to whether the stamp is correctly positioned on the thorax. In this way, the stamp position check helps the user to adjust the height of the arm correctly. The arm shows the result of the stamp position check using the LED of the **Start/Stop** key and the display.

After the user has switched on the arm and released the locking lever, the stamp position check starts. The following table shows the possible results, corresponding descriptions, and necessary measures that the user must take.

Result		Description	Measure
LED of the Start/Stop key	Symbol in the display		
		<ul style="list-style-type: none"> • Arm too low • Release of the thorax not ensured • Therapy not possible 	<ul style="list-style-type: none"> • Adjust the arm higher
		<ul style="list-style-type: none"> • Arm too high • If there is a visible contact between thorax and stamp, the user still can start therapy. • Configured compression depth not ensured throughout 	<ul style="list-style-type: none"> • Adjust the arm lower
		<ul style="list-style-type: none"> • Arm adjusted optimally • Full release and configured compression depth are ensured 	<ul style="list-style-type: none"> • None

Tab. 9-5 Stamp position check



After every therapy pause, the arm checks the stamp position. If required, the arm attempts to compensate for a sunken thorax. If the arm can no longer compensate the difference, the arm signals a medium priority alarm (see Medium priority alarms on page 56).



The arm regularly checks whether full release of the thorax is achieved. If full release of the thorax is no longer ensured, the arm signals a high priority alarm (see High priority alarms on page 54).

9.4 Therapy Settings

The following therapy settings may be selected:

Display field	Setting option	Description
„Mode“	<ul style="list-style-type: none"> • 30:2 • 15:2 • cont. 	<ul style="list-style-type: none"> • Ratio of compressions to ventilation cycles • Continuous compressions without pauses for ventilation
"Compression depth"	<ul style="list-style-type: none"> • 2.0 cm to 6.0 cm 	<ul style="list-style-type: none"> • Adjustable in increments of 0.1 cm
"Compression rate"	<ul style="list-style-type: none"> • 80 /min to 120 /min compressions 	<ul style="list-style-type: none"> • Configurable in increments of 1 /min

Tab. 9-6 Therapy settings

9.4.1 Configuring Therapy Settings

The user can configure the therapy settings before as well as during therapy.

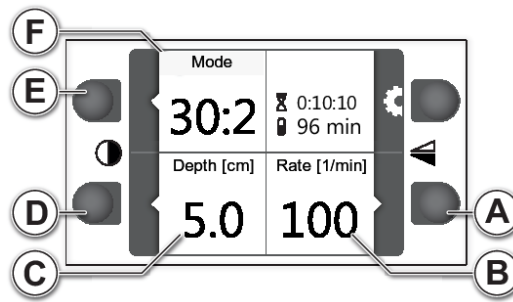

Fig. 9-6 Therapy settings - display on main screen

Item	Element	Description
A	[Pressure frequency] softkey	Calls up the configuration dialogue "Compression rate".
B	Display field "Compression rate"	Shows the configured compression rate in 1 /min.
C	Display field "Compression depth"	Display of the pressure depth in cm.
D	[Pressure depth] softkey	Calls up the configuration dialogue "Compression depth".
E	[Mode] softkey	Calls up the selection dialogue "Mode".
F	Display field "Mode"	Display of the active mode.

Tab. 9-7 Therapy settings - display on main screen



The settings for depth and rate of compression can only be changed in usage selection mode **ADVANCED** (see 12.4 Usage Selection on page 93).

Mode

To open the selection dialogue "Mode", proceed as follows:



1. Press the softkey [Mode].
The selection dialogue "Mode" appears.

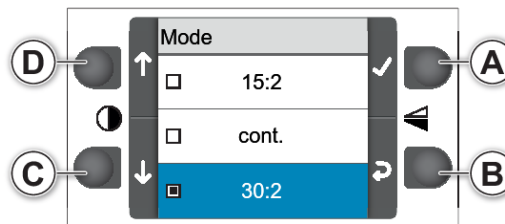

Fig. 9-7 Selection dialogue "Mode"

Item	Element	Description
A	Softkey [Confirm]	Activates the checkbox for the highlighted mode.
B	Softkey [Back]	Back to previous screen.
C	Softkey [Down]	Navigates down through the selection dialogue.
D	Softkey [Up]	Navigates up through the selection dialogue.

Tab. 9-8 Selection dialogue "Mode"



To select a therapy mode, proceed as follows:

1. Navigate to the mode option using the softkeys [Up] and [Down].
2. Activate the checkbox using the softkey [Confirm].
3. Return to the main screen using the softkey [Back].

Compression Depth and Compression Rate

To change the compression rate or compression depth, proceed as follows:



1. Press the softkey [Compression rate] or [Compression depth].
The configuration dialogue "Compression rate" or "Compression depth" appears (see 7.3.4 Configuration Dialogues on page 44).



The user does not need to confirm the configuration dialogues for compression rate and compression depth. The changed settings are immediately active. This only applies for the configuration dialogues of the main screen.

2. Return to the main screen using the softkey [Back].

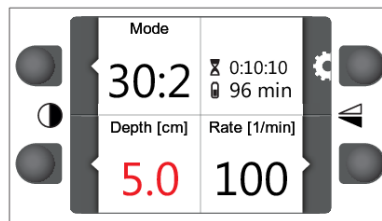

Fig. 9-8 Compression depth if the thorax is very rigid



In patients whose thorax is very rigid, it is possible that the user might not operate the corpuls cpr in accordance with specifications. As a result, the configured compression depth is no longer ensured throughout. The display then shows the compression depth in red.

9.5 Performing Therapy

This chapter describes how to start, stop/pause and resume therapy.

9.5.1 Softstart

So that the thorax of the patient can adjust to the compressions, the arm gradually increases the compression depth. When starting therapy initially or when continuing therapy after operating the locking lever, the arm starts with a softstart.

Compression	Compression depth
First compression	52 % of the configured compression depth
Second compression	75 % of the configured compression depth
Third compression	89 % of the configured compression depth
All further compressions	100 % of the configured compression depth

Tab. 9-9 Softstart



After a compression pause for ventilation, the arm begins therapy at 100 % of the configured compression depth.

9.5.2 Starting, Stopping/Pausing and Resuming Therapy

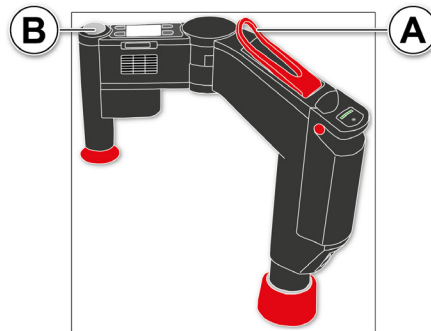

Fig. 9-9 Starting, stopping/pausing and resuming therapy

Item	Element	Description
A	Locking lever	The following functions are available: <ul style="list-style-type: none"> • Immobilisation of the arm • Releasing the patient
B	Start/Stop key	The following functions are available: <ul style="list-style-type: none"> • Starting therapy • Pausing/stopping the therapy • Displaying alarms

Tab. 9-10 Starting, stopping/pausing and resuming therapy

To start the therapy, proceed as follows:



Prerequisite:

- ✓ The arm is switched on and operational (see 9.3.4 Switching On the Arm on page 68)
- ✓ The arm is adjusted (see 9.3.5 Adjusting the Arm on page 69)
- ✓ The stamp position check allows the therapy to begin (see 9.3.6 Stamp Position Check on page 70)

1. Press the **Start/Stop** key.

Therapy starts.



Therapy begins with factory settings (see 10 Factory Settings on page 78), or with settings that have been adjusted by the OPERATOR (see 12.9 Storing the Configuration on page 97).



Therapy cannot begin until the locking lever has been closed.



Therapy can only be started once initial opening of the locking lever has been carried out in order to adjust the arm.

To stop/pause therapy, proceed as follows:



Prerequisite:

- ✓ Therapy has been started

1. Press the **Start/Stop** key.

The arm stops/pauses therapy. Full release of the thorax.



The function "Pause Therapy" only interrupts therapy. The current settings are retained for further continuation of the therapy.



The LED of the **Start/Stop** key indicates a pause in therapy by flashing yellow and an acoustic alarm signal is emitted. The display shows a medium priority alarm. If therapy is not resumed within 8 s, this alarm is escalated to a higher priority (see High priority alarms on page 54).



If the synchronised therapy is paused, a medium-priority alarm is only issued after 15 s. If therapy is not resumed within a further 8 s, this alarm is escalated to a higher priority (see High priority alarms on page 54).

In an emergency, therapy can be interrupted using the following measures:

- Press the **Start/Stop** key (see 5.2 Components of the Arm on page 21)
- Switch off the arm (see 9.6 Switching Off the Arm on page 75)
- Open the locking lever (see 5.2 Components of the Arm on page 21)
- Remove the battery (see 6.2.3 Changing the Battery on page 34)

To resume therapy, proceed as follows:



Prerequisite:

- ✓ Therapy is paused

1. Press the **Start/Stop** key.

The arm resumes therapy using the previous therapy settings.



Therapy cannot begin until the locking lever has been closed.



The user can also resume therapy while the **Therapy stopped** alarm is active. The alarm is then stopped.

9.5.3 Battery Replacement Concept

If the battery needs to be replaced while therapy is in progress, this is possible without losing the current therapy settings (see 9.4 Therapy Settings on page 71). Even if the battery has been removed, these therapy settings remain saved for a maximum of 30 s. Restarting therapy after replacing the battery is possible without initially opening the locking lever.



To reduce the time without therapy to a minimum, always have a charged reserve battery available.

9.6 Switching Off the Arm

If no further therapy is planned, the arm must be switched off.



First stop therapy, then switch off the arm.

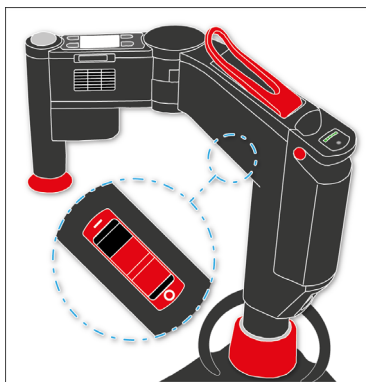

Fig. 9-10 Switching off the arm

To switch off the arm, proceed as follows:



Prerequisite:

- ✓ The arm is switched on (see 9.3.4 Switching On the Arm on page 68)
- ✓ Therapy has been stopped (see 9.5.2 Starting, Stopping/Pausing and Resuming Therapy on page 74)

1. Push the **On/Off** switch at the underside of the arm to the "Off" position.

On the display of the arm, a countdown appears. This countdown signals to the user that the arm will switch itself off within 5 s. The device emits an indication tone and the LED of the **Start/Stop** key flashes up white. The display goes dark.

Before the countdown, messages may appear on the display unit of the arm. The user can confirm these messages (see 8.3.2 Alarm Confirmation and Alarm Suspension on page 58).



The user can cancel the power-down procedure during the countdown. To do so, push the **On/Off** switch to the "On" position. The display shows the previous screen content.



If the user switches the arm on again within 30 s, all previously modified settings are retained (see 9.5.3 Battery Replacement Concept on page 75).



Switching the arm off while therapy is in progress ends therapy immediately. The arm does not signal any alarm.

9.7 Removing the Stamp

The following section describes removing the stamp from the arm.

To remove the stamp from the arm, proceed as follows:



1. Pull the stamp downwards out of the holder on the arm (see 5.2 Components of the Arm on page 21).

9.8 Disassembling the Arm

To disassemble the arm, proceed as follows:



Prerequisite:

- ✓ The arm is switched off (see 9.6 Switching Off the Arm on page 75)

1. Turn the bayonet lock counterclockwise and hold.
2. Pull the arm upwards from the socket of the therapy board.



To disassemble the arm, the user needs both hands.

9.9 Synchronised Therapy with corpuls3



WARNING!

Patient slipping due to shock release during synchronised therapy!

May impair therapy success. Can lead to injuries of the patient.

- ▶ Always supervise the pressure position during therapy and correct, if necessary.
- ▶ Always secure the patient sufficiently for synchronised therapy.

The user can perform a synchronised therapy with the corpuls cpr in combination with the corpuls3 .

So the user can have the therapy data of the corpuls cpr displayed on the corpuls3 and control the functions of the corpuls cpr with the corpuls3 .

The user can start, pause, and stop the synchronised therapy via the corpuls3 as well as configure the following therapy parameters:

- Compression depth
- Compression rate
- Therapy mode

Prerequisite:

- There is a Bluetooth connection to the corpuls3 (see 7.6.5 Pairing and Connecting Bluetooth Devices on page 48)
- The corpuls cpr is adjusted correctly by means of the stamp position check (see 9.3.6 Stamp Position Check on page 70)

The user can control all functions of the corpuls cpr via the corpuls cpr during synchronised therapy.

For further information on synchronised therapy the user has to read the user manual of the corpuls3 .



The user must always supervise the patient and the corpuls cpr during synchronised therapy.

10 Factory Settings

Setting	Value	
Mode	30:2	
Compression depth	5.5 cm	
Compression rate	100 1/min	
Usage selection	Advanced	
User level	DEFAULT	
Duration of the pause for ventilation	4 s	
Volume	10	
LED - brightness	7	
Backlight	7	
Start screens	Not active	
Key tone	Enabled	
Ventilation signal frequency	10 1/min	
Duration of alarm suspension	120 s	
Code for user level DEFAULT	0 0 0 0	
Code for user level OPERATOR	1 0 0 0	
Bluetooth	Not active	
BT PIN	1 2 3 4	
LED	Enabled	
Audio	Enabled	
Reminder signal	Enabled	
Language	English	
Patient group 1	Mode	30:2
	Compression depth	6.0 cm
	Compression rate	100 1/min
Patient group 2	Mode	30:2
	Compression depth	5.5 cm
	Compression rate	100 1/min
Patient group 3	Mode	30:2
	Compression depth	5.0 cm
	Compression rate	100 1/min

Tab. 10-1 Factory settings



The settings can only be changed in usage selection mode **ADVANCED** (see 12.4 Usage Selection on page 93).

11 Configuration at User Level DEFAULT

The user can log in at different user levels. Every user level has different configuration options. Non visible configuration options can only be accessed at higher user levels. This chapter provides an overview of the configuration options at user level DEFAULT.



At user level DEFAULT, changed settings cannot be saved. These settings are no longer available when the arm is restarted. The arm saves date and time settings automatically.



Changed settings can only be permanently saved at user level OPERATOR or higher.



The settings can only be changed in usage selection mode ADVANCED (see 12.4 Usage Selection on page 93).

11.1 Menu item Bluetooth

Under the menu item *Bluetooth*, the user can pair the corpuls cpr with a Bluetooth device via the Bluetooth PIN (see 7.6.5 Pairing and Connecting Bluetooth Devices on page 48).

11.2 Menu item User level

To change the settings of the arm, the user must open the menu "Settings" (see 7.3 Menu on page 42).

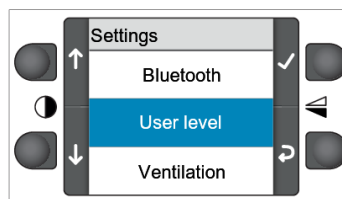

Fig. 11-1 User level

To activate the selection of the user level, proceed as follows:



1. Navigate to the menu item *User level* using the softkeys [Up] and [Down].
2. Activate the selection using the softkey [Confirm].

The display switches to the login screen for entering the 4-digit code.

The user can switch to another user level by entering a 4-digit code (see 10 Factory Settings on page 78).

The following user levels may be selected:

- DEFAULT
- OPERATOR

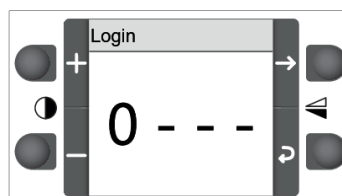

Fig. 11-2 Login screen



To enter the code, proceed as follows:

1. Navigate to the location of the code using the softkeys [Right] and [Left].
2. Set the number using the softkeys [Plus] and [Minus].
3. Confirm the code entered by pressing the softkey [Confirm].



The softkey [Confirm] can only be selected when the last digit of the code is highlighted.

Once the code has been confirmed, the display shows one of the following messages for 3 s:

- If a mistake has been made during entry: <Invalid code>
- If entered correctly: <Logged in as: "User level">



After 3 s, the display switches back to the settings menu.

11.3 Menu item Ventilation

Depending on the therapy mode, different ventilation messages can be configured.

Ventilation message	15:2	30:2	cont.
Switching the acoustic reminder signal on or off for the last five compressions before a pause for ventilation.	Yes	Yes	No
Switching on or off the blue reminder signal of the LED of the Start/Stop key during the compression pause for ventilation.	Yes	Yes	No
Configure the duration of the compression pause for ventilation.	Yes	Yes	No
Switching the acoustic reminder signal for ventilation on or off.	No	No	Yes
Switching on or off the blue reminder signal of the LED of the Start/Stop key for ventilation.	No	No	Yes
Setting the repetition frequency of the ventilation message.	No	No	Yes

Tab. 11-1 Overview of ventilation messages

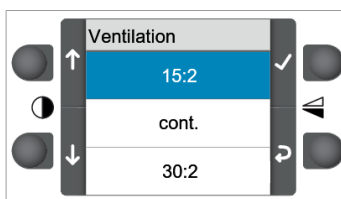

Fig. 11-3 Menu item Ventilation

To open the menu item *Ventilation*, proceed as follows:



1. Navigate to the menu item *Ventilation* using the softkeys [Up] and [Down].
2. Activate the selection using the softkey [Confirm].

The menu item *Ventilation* is open.

The display shows the therapy modes.

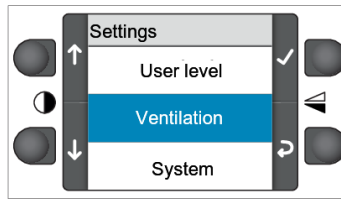

Fig. 11-4 Menu "Ventilation"

To select a therapy mode, proceed as follows:



1. Navigate to the therapy mode using the softkeys [Up] and [Down].
2. Activate the selection using the softkey [Confirm].

The display shows the configuration options for ventilation in the selected therapy mode.

11.3.1 Therapy Modes 15:2 and 30:2

The configuration options for the therapy modes 15:2 and 30:2 are identical.

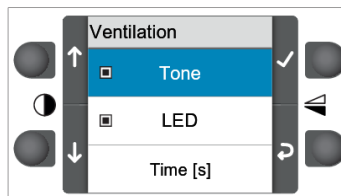

Fig. 11-5 Therapy modes 15:2 and 30:2

The following settings are possible:

- Acoustic reminder signal
- Reminder signal of the LED of the **Start/Stop** key
- Duration of the ventilation pause

Tone

The acoustic reminder signal for the last five compressions before a pause for ventilation can be switched on or off.

To switch the acoustic reminder signal for ventilation on or off, proceed as follows:



1. Navigate to the submenu item > *Tone* using the softkeys [Up] and [Down].
2. Activate or deactivate the checkbox using the softkey [Confirm].

The acoustic reminder signal for ventilation is switched on or off.

LED

The reminder signal of the LED of the **Start/Stop** key during the compression pause for ventilation can be switched on or off.

To switch the reminder signal for ventilation on or off, proceed as follows:

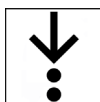

1. Navigate to the submenu item > *LED* using the softkeys [Up] and [Down].
2. Activate or deactivate the checkbox using the softkey [Confirm].

The reminder signal for ventilation is switched on or off.

Time [s]

The ventilation pause can be set in 1-second steps from 3 s to 8 s.

To configure the duration of the compression pause for ventilation, proceed as follows:



1. Navigate to the submenu item > *Time [s]* using the softkeys [Up] and [Down].
2. Activate the selection using the softkey [Confirm].
The configuration dialogue "Time [s]" appears (see 7.3.4 Configuration Dialogues on page 44).

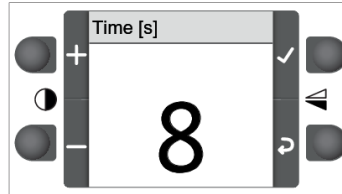

Fig. 11-6 Configuration dialogue "Time [s]"

3. Configure the duration of the compression pause for ventilation.
The duration of the compression pause for ventilation has been configured. The display shows the previous screen.

11.3.2 Therapy Mode Cont.

In therapy mode "Cont.", an audiovisual reminder signal for ventilation can be set.

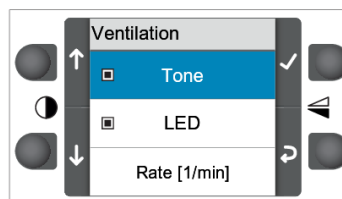

Fig. 11-7 Therapy mode "Cont."

The following settings are possible:

- Acoustic reminder signal for ventilation
- Reminder signal of the LED of the **Start/Stop** key for ventilation
- Repetition frequency of the visual and acoustic reminder signals

Tone

The acoustic reminder signals for ventilation during continuous therapy can be switched on or off.

To switch the acoustic reminder signals on or off, proceed as follows:



1. Navigate to the submenu item > *Tone* using the softkeys [Up] and [Down].
2. Activate or deactivate the checkbox using the softkey [Confirm].
The acoustic reminder signals have been switched on or off.

LED

The reminder signals for ventilation during continuous therapy can be switched on or off.

To switch the reminder signal on or off, proceed as follows:



1. Navigate to the submenu item > *LED* using the softkeys [Up] and [Down].
2. Activate or deactivate the checkbox using the softkey [Confirm].
The reminder signal has been switched on or off.

Rate [1/min]

The repetition frequency of the acoustic and visual reminder signals can be set in increments of 6 to 30 times per minute.

To configure the repetition frequency of the acoustic and visual reminder signals, proceed as follows:



1. Navigate to the submenu item > *Freq [1/min]* using the softkeys [Up] and [Down].
2. Activate the selection using the softkey [Confirm].

The configuration dialogue "Ventilation rate [1/min]" appears (see 7.3.4 Configuration Dialogues on page 44).

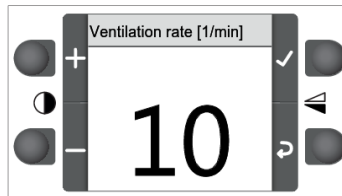

Fig. 11-8 Configuration dialogue "Ventilation rate [1/min]"

3. Adjust the repetition frequency of the visual and acoustic reminder signals.

The repetition frequency of the acoustic and visual reminder signals has been configured. The display shows the previous screen.



To minimise the risk of stomach distention or gastric reflux, make sure to ventilate simultaneously with the reminder tone and reminder signal. Reminder tone and reminder signal are synchronised with the moment of full release.

11.4 Menu item System

In the menu item *System*, general settings for the arm can be configured.

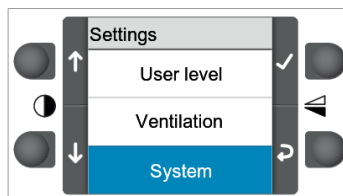

Fig. 11-9 Menu item System

To open the menu item *System*, proceed as follows:



1. Navigate to the menu item *System* using the softkeys [Up] and [Down].
2. Activate the selection using the softkey [Confirm].

The menu item *System* is open.

The display shows the contents of the menu item *System*.

The menu item *System* contains the following entries:

- Info
- LED brightness
- Display brightness
- Volume
- Time
- Date
- Audiovisual signals
- Bluetooth
- UDI info

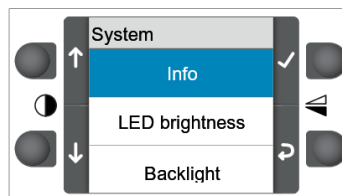

Fig. 11-10 Menu item System

To configure the system settings, proceed as follows:



1. Navigate to a Submenu item using the softkeys [Up] and [Down].
2. Activate the selection using the softkey [Confirm].

The display shows the contents of the selected Submenu item.

11.4.1 Info

The submenu item > *Info* includes the following contents:

Display	Description
Serial number	Serial number
SPC version	Version of the application software
SPC boot version	Bootloader version
Resources version	Version of the resources file
STM version	Version of the control firmware
STM boot version	Bootloader version of motor control
Bluetooth MAC	MAC address of the Bluetooth module
Bluetooth PIN	PIN code of the Bluetooth module
Bluetooth licence	Status Bluetooth licence
Bluetooth state	Status Bluetooth module
Next STK	Date of the next maintenance
Batt. ser. number	Battery serial number
Batt. lot number	Lot number of the battery
Batt. prod. date	Production date of the battery
Batt. cycle count	Number of charging cycles of the battery
Batt. max. diff.	Balance indicator Battery
Power on time	Operating hours
Tot. therapy time	Deployment time

Tab. 11-2 Info

11.4.2 LED - Brightness

The brightness of the LED of the **Start/Stop** key can be gradually adjusted from 1 to 10 in a configuration dialogue (see 7.3.4 Configuration Dialogues on page 44).

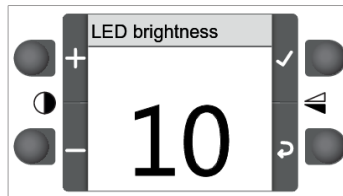

Fig. 11-11 LED - brightness

11.4.3 Backlight

The brightness of the display can be configured in increments of 1 to 10 in a configuration dialogue (see 7.3.4 Configuration Dialogues on page 44).

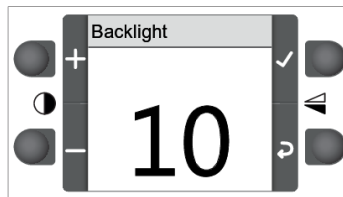

Fig. 11-12 Backlight

11.4.4 Volume

The volume of the signals can only be viewed at user level DEFAULT.

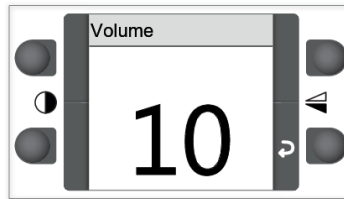

Fig. 11-13 Volume

11.4.5 Time

The user can set the time.

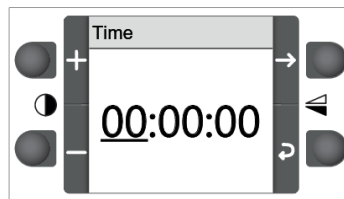

Fig. 11-14 Time - hours

To set the current time, proceed as follows:



1. Set the correct time (hours) using the softkeys [Plus] and [Minus].
2. Select the minutes using the softkey [Right].
The minutes are highlighted.

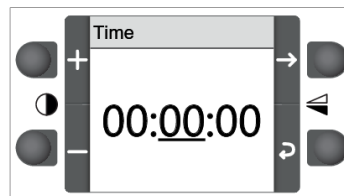

Fig. 11-15 Time - minutes

3. Set the correct time (minutes) using the softkeys [Plus] and [Minus].
4. Select the seconds using the softkey [Right].
The seconds are highlighted.

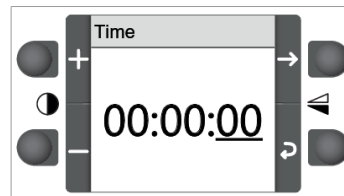

Fig. 11-16 Time - seconds

5. Set the correct time (seconds) using the softkeys [Plus] and [Minus].
6. Confirm the time entered by pressing the softkey [Confirm].



The softkey [Confirm] can only be selected when the seconds are highlighted.

The time has been set.

11.4.6 Date

The user can set the date.

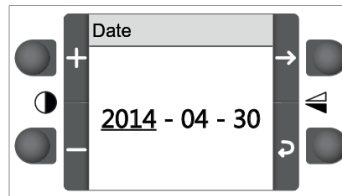

Fig. 11-17 Date - year

To set the date, proceed as follows:



1. Set the correct year using the softkeys [Plus] and [Minus].
2. Select the month using the softkey [Right].

The month is highlighted.

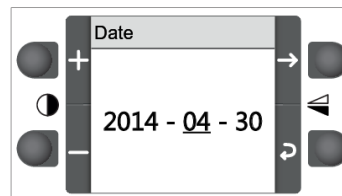

Fig. 11-18 Date - month

3. Set the correct month using the softkeys [Plus] and [Minus].
4. Select the day using the softkey [Right].

The day is highlighted.

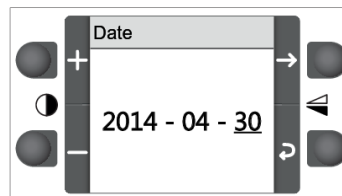

Fig. 11-19 Date - day

5. Set the correct day using the softkeys [Plus] and [Minus].
6. Confirm the date entered by pressing the softkey [Confirm].



The softkey [Confirm] can only be selected when the day is highlighted.

The date has been set.

11.4.7 Audiovisual Signals

The user can activate or deactivate the key tones in the submenu item > *Audiovisual signals*.



At user level OPERATOR, additional settings are available (see 12 Configuration at User Level OPERATOR on page 90).

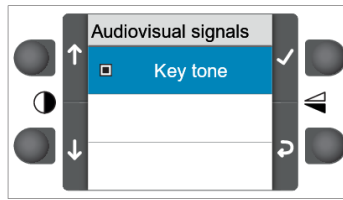

Fig. 11-20 Audiovisual signals

To switch the key tones on or off, proceed as follows:



1. Activate or deactivate the checkbox using the softkey [Confirm].
The key tones have been switched on or off.

11.4.8 Bluetooth settings

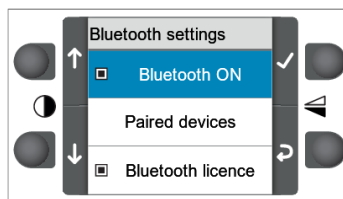

Fig. 11-21 Bluetooth settings

The user has the following options in submenu item > *Bluetooth settings*.

- Enabling/disabling Bluetooth function
- Opening the list of paired devices
- Checking the Bluetooth license

Enabling/disabling the Bluetooth function

To enable or disable the Bluetooth function, proceed as follows:



Prerequisite:

- ✓ User is logged in at user level DEFAULT-Advanced
- ✓ The user has permanently enabled the Bluetooth function at user level OPERATOR (see Enabling/disabling the Bluetooth function permanently on page 92)

1. Use the softkeys [Up] and [Down] to navigate to the entry *Bluetooth ON*.
2. Check or uncheck the checkbox with the [Confirm] softkey.
The Bluetooth function is enabled or disabled.



If the user has not enabled the Bluetooth function permanently at user level OPERATOR, the message <Bluetooth blocked, action not possible> appears in the display.

Viewing the list of paired devices

The user can store up to 6 Bluetooth devices in the list of paired devices. If the user connects another Bluetooth device, the device that was not connected with the corpuls cpr for the longest time will be deleted from the list of paired devices.

To view a list of already paired devices, proceed as follows:



1. Use the softkeys [Up] and [Down] to navigate to the menu item *Paired devices*.
2. Open the list of paired devices with the softkey [Confirm].
In the display appears the list of already paired devices with Mac addresses.



The MAC address is the hardware address of the Bluetooth module and serves as identification of the Bluetooth device. The MAC address cannot be changed.

Checking the Bluetooth license

The user can check whether there is a Bluetooth license available. If there is no Bluetooth license available, the user cannot use the Bluetooth function.

If a Bluetooth license is available, the checkbox of the submenu item > *License* is selected.

11.4.9 UDI Information

The user can check the UDI information. This is e.g. useful to identify the corpuls cpr quickly and unequivocally.

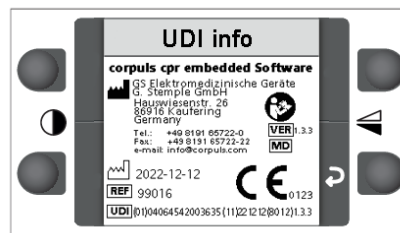

Fig. 11-22 UDI Information

12 Configuration at User Level OPERATOR

At user level OPERATOR, the user has the same configuration options available as at user level DEFAULT (see 11 Configuration at User Level DEFAULT on page 79). In the user level OPERATOR, the user has further configuration options available in the menu item *System*. This chapter provides an overview of the additional configuration options.



The arm always starts at user level DEFAULT. To change settings at user level OPERATOR, the user must be logged in at user level OPERATOR (see 11.2 Menu item User level on page 79).



So that the modified settings are active the next time the arm is started, the user must save these settings (see 12.9 Storing the Configuration on page 97).

To open the menu item *System*, proceed as described in the chapter on settings at user level DEFAULT (see 7.3 Menu on page 42).

To configure the system settings, proceed as described in the chapter on settings at user level DEFAULT (see 11.4 Menu item System on page 83).

12.1 Volume

The volume of signals from the arm can be configured in increments of 1 to 10 in a configuration dialogue (see 7.3.4 Configuration Dialogues on page 44).

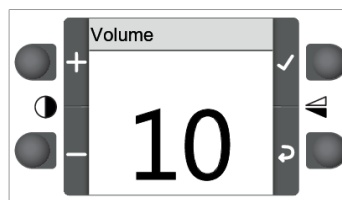

Fig. 12-1 Volume



If the volume of the signals is too low and the area is very noisy, the user may not notice the alarm signals.

12.2 Audiovisual Signals

At user level OPERATOR, the user can switch the audiovisual signals on or off.



Deactivating audiovisual signals is not recommended. Deactivating audiovisual signals requires increased duty of care on the part of the user.

12.2.1 Turning Key Tones On or Off

The user can turn the key tones on or off.

To turn the key tones on or off, proceed as described in chapter "Settings User Level DEFAULT" (see 11.4.7 Audiovisual Signals on page 87).

12.2.2 Turning the LED On or Off

The user can turn the signals of the LED of the **Start/Stop** key on or off.

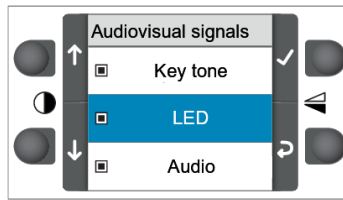

Fig. 12-2 Audiovisual signals - LED

To switch the LED signals on or off, proceed as follows:



1. Navigate to the menu item *LED* using the softkeys [Up] and [Down].
2. Activate or deactivate the checkbox using the softkey [Confirm].

The LED signals have been switched on or off.

12.2.3 Turning Audio Signals of the Alarm Generator On or Off

The user can turn audio signals of the alarm generator on or off.

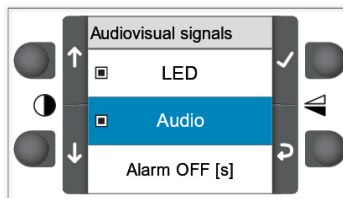

Fig. 12-3 Audiovisual signals - Audio

To switch the signals of the alarm generator on or off, proceed as follows:



1. Navigate to the menu item *Audio* using the softkeys [Up] and [Down].
2. Activate or deactivate the checkbox using the softkey [Confirm].

The audio signals of the alarm generator have been switched on or off.

12.2.4 Configuring the Duration of the Alarm Suspension

The user can configure the duration of alarm suspension from 15 s to 120 s.

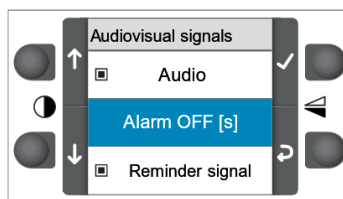

Fig. 12-4 Audiovisual signals - Alarm OFF [s]

To change the duration of alarm suspension, proceed as follows:



1. Navigate to the submenu item > *Alarm OFF [s]* using the softkeys [Up] and [Down].
2. Activate the selection using the softkey [Confirm].
The configuration dialogue "Time [s]" appears (see 7.3.4 Configuration Dialogues on page 44).

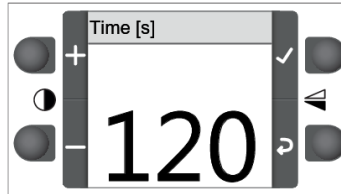

Fig. 12-5 Configuration dialogue - Alarm OFF [s] - Time [s]

3. Configure the duration of alarm suspension.

12.2.5 Turning the Reminder Signal On or Off

The reminder signal for alarm suspension on or off.

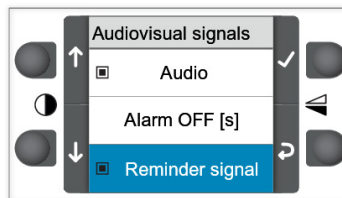

Fig. 12-6 Audiovisual signals - Reminder signal

To switch the reminder signal on or off, proceed as follows:



1. Navigate to the menu item *Reminder signal* using the softkeys [Up] and [Down].
2. Activate or deactivate the checkbox using the softkey [Confirm].

12.3 Bluetooth settings

Enabling/disabling the Bluetooth function permanently

The user can enable or disable the Bluetooth function permanently at user level OPERATOR.

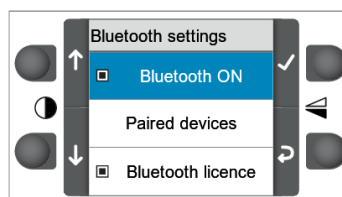
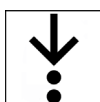

Fig. 12-7 Bluetooth settings

To enable or disable the Bluetooth function permanently, proceed as follows:



Prerequisite:

- ✓ User is logged in at user level OPERATOR
1. Use the softkeys [Up] and [Down] to navigate to the entry *Bluetooth ON*.
 2. Check or uncheck the checkbox with the [Confirm] softkey.
 3. Save the changes (see 12.9 Storing the Configuration on page 97).

The Bluetooth function is enabled or disabled permanently.



If the user wants to permanently enable or disable the Bluetooth function, the changes have to be saved at user level OPERATOR (see 12.9 Storing the Configuration on page 97).

12.4 Usage Selection

At user level OPERATOR, the usage selection can be changed.



WARNING!

Jeopardized therapeutic success due to delayed therapy!

In the usage selection mode BASIC, the user cannot change a wrongly selected patient configuration in the start screen. Changing the patient configuration in the start screen is only possible after switching off the device for 30 s and re-starting the device.

► Pay close attention when selecting the patient class.

With factory settings, the arm starts in usage selection mode ADVANCED (see 10 Factory Settings on page 78).

Only in usage selection mode ADVANCED, the user can change system settings, compression depth and compression rate (see 9.4.1 Configuring Therapy Settings on page 71). In usage selection mode BASIC, only the functions "Mode", "Bluetooth" and "User level" can be selected.

To change a usage selection option, proceed as follows:



1. Navigate with the softkeys [Up] and [Down] to the required Usage selection option.

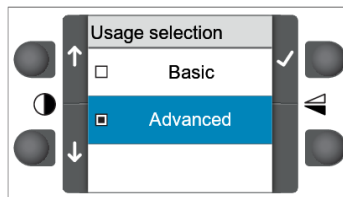

Fig. 12-8 Usage selection

2. Activate the checkbox using the softkey [Confirm].
The usage selection has been changed.



The change in usage selection has to be saved in order to be active at the next start of the arm.

Usage selection mode BASIC and ADVANCED can be clearly distinguished from one another in terms of main screen layout.

The following illustration shows the main screen in usage selection mode ADVANCED. All four softkeys can be activated. A corresponding symbol is provided on the display for each softkey.

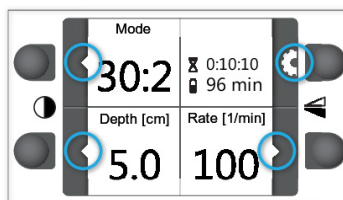

Fig. 12-9 Main screen in usage selection mode ADVANCED

The following functions are available to the user in usage selection mode **ADVANCED**:

- Changing menu settings
- Changing compression rate for therapy
- Changing compression depth for therapy
- Changing therapy mode
- Activating all quick selection functions

The following illustration shows the main screen in usage selection mode **BASIC**. Only the softkey [Mode] can be activated. A corresponding symbol is provided on the display for the softkey [Mode].

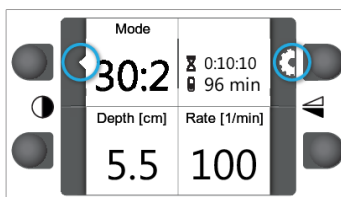

Fig. 12-10 Main screen in usage selection mode **BASIC**

The following functions are available to the user in usage selection mode **BASIC**:

- Changing therapy mode
- Activating all quick selection functions



In synchronised mode with the corpuls3 , the user can configure settings on the corpuls cpr via the corpuls3 although the **BASIC** usage is set.

12.5 Changing Codes

The user can change the codes for the user levels **DEFAULT** and **OPERATOR**.

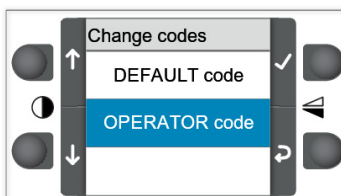

Fig. 12-11 Changing codes

To change the code for a user level, proceed as follows:



1. Navigate to the user level using the softkeys [Up] and [Down].
2. Confirm the selection using the softkey [Confirm].

The display switches to the configuration dialogue for entering the 4-digit code.

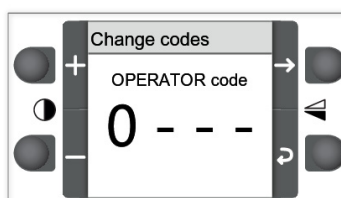

Fig. 12-12 Changing codes - configuration dialogue

3. Navigate to a location of the code using the softkeys [Right] and [Left].
4. Set the number using the softkeys [Plus] and [Minus].

5. Confirm the code entered by pressing the softkey [Confirm].



The softkey [Confirm] can only be selected when the last digit of the code is highlighted.

Once the code has been confirmed, the display shows one of the following messages for 3 s:

- If the code is already in use: <Invalid code>
- In the case of a new valid code: <Code changed>

12.6 Language

The language of the system can be changed.

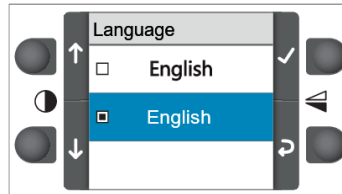

Fig. 12-13 Language

To select a different language, proceed as follows:



1. Navigate to "Language" using the softkeys [Up] and [Down].
2. Activate the checkbox using the softkey [Confirm].

12.7 Patient Settings

At user level OPERATOR, the user can configure the therapy settings individually for up to three patient groups. When the start screen "Patient" is active (see 7.5.1 Start Screen Patient on page 46), the user has to select a configuration.

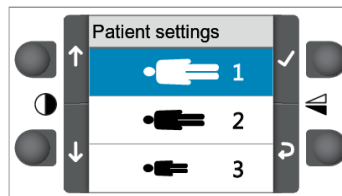

Fig. 12-14 Patient settings

To configure the patient settings, proceed as follows:



1. Navigate to the patient group using the softkeys [Up] and [Down].
2. Select the patient group using the softkey [Confirm].

The settings menu for the selected patient group appears.

Patient groups 1, 2 and 3

The following section describes individual modification of the therapy settings for the patient groups.

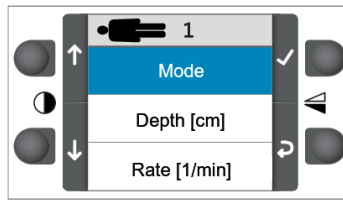

Fig. 12-15 Therapy settings, patient group 1

The following instruction explains how to modify the therapy settings for patient group1. Patient groups 2 and 3 can be modified accordingly.

To configure the therapy settings for patient group1, proceed as follows:



1. Navigate to a therapy setting using the softkeys [Up] and [Down].
2. Activate the selection using the softkey [Confirm].
The selection- or configuration dialogue of a therapy setting appears (see 7.3.4 Configuration Dialogues on page 44).
3. Adjust the therapy setting in the selection- or configuration dialogue.
4. Use the softkey [Back] to return to the therapy settings of patient group1.
5. Navigate to another therapy setting using the softkeys [Up] and [Down].
6. Activate the selection using the softkey [Confirm].
The selection- or configuration dialogue of a further therapy setting appears (see 7.3.4 Configuration Dialogues on page 44).
7. Adjust the therapy setting in the selection- or configuration dialogue.
8. Use the softkey [Back] to return to the therapy settings of patient group1.
9. Return to the patient settings using the softkey [Back].
The therapy settings for patient group1 have been configured.

12.8 Start Screen

At user level OPERATOR, the user can configure two start screens. These start screens appear first when the user switches on the arm. The display then shows the main screen.

The following start screens are available:

- Patient
- Mode

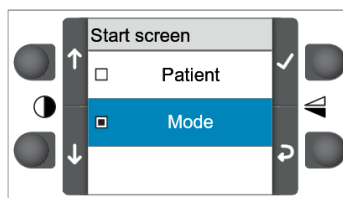
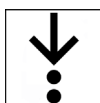

Fig. 12-16 Settings "Start screen"

To change the start screens, proceed as follows:



1. Navigate to "Start screen" using the softkeys [Up] and [Down].
2. Activate the checkbox using the softkey [Confirm].
The start screen is activated.

3. Navigate to another start screen using the softkeys [Up] and [Down].
4. Activate the checkbox using the softkey [Confirm].
The next start screen is activated.
The start screens have been changed.



Multiple selection is possible. The user has to store changed settings, so that the start screens will appear in sequence the next time the arm is started (see 12.9 Storing the Configuration on page 97).

12.9 Storing the Configuration

So that the modified settings are retained the next time the arm is started, the user must save these changes.

To save the settings, proceed as follows:



1. Confirm the confirmation dialogue (see 7.3.3 Confirmation Dialogues on page 43).
A green confirmation tick indicates that saving the settings was successful. The screen switches to the menu "System".



A red X-symbol indicates that the procedure failed.



If the user changes the therapy settings of the main screen (see 9.4 Therapy Settings on page 71), these changes are retained after the settings have been saved. The therapy settings are active in the main screen the next time the arm is started.

12.10 Exporting the Configuration

To transfer the modified settings to other corpuls cpr arms, the user can export these settings to the SD card.

The arm exports the following settings:

- Codes for the user levels *DEFAULT* and *OPERATOR*
- Settings in the menu item *Ventilation*
- Settings in the menu item *System*

To export the settings, proceed as follows:



Prerequisite:

- ✓ An SD card is inserted in the SD card slot (see 6.3 Inserting the SD Card on page 35)

1. Confirm the confirmation dialogue (see 7.3.3 Confirmation Dialogues on page 43).
A green confirmation tick indicates that exporting the settings was successful. The screen switches to the menu "System".



A red X-symbol indicates that the procedure failed.



The arm does not export the therapy settings in the main screen.



The arm writes a file called SETUP.DAT to the master directory of the SD card.

If a file called SETUP.DAT already exists, the arm overwrites this file.

12.11 Importing the Configuration

The user can import exported settings from the SD card to other corpuls cpr devices.



A file called SETUP.DAT must be located in the master directory of the SD card.

To import settings, proceed as follows:



1. Confirm the confirmation dialogue (see 7.3.3 Confirmation Dialogues on page 43).
A green confirmation tick indicates that importing the settings was successful. The screen switches to the menu "System".



A red X-symbol indicates that the procedure failed.



SETUP.DAT overwrites existing settings with the imported settings.



In order to also use the imported settings after the arm is restarted, the user must save these settings (see 12.9 Storing the Configuration on page 97).

12.12 Changing the Bluetooth PIN

The user can change the Bluetooth PIN.

To change the Bluetooth PIN, proceed as follows:



Prerequisite:

- ✓ User is logged in at user level OPERATOR

1. Open the configuration dialogue for entering the 4-digit code.

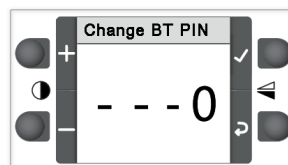

Fig. 12-17 Changing Bluetooth PIN - Configuration dialogue

2. Use the softkeys [Right] and [Left] to navigate to a location of the Bluetooth PIN.
3. Set the number using the softkeys [Plus] and [Minus].
4. Confirm the Bluetooth PIN entered by pressing the softkey [Confirm]. The user can only select the softkey [Confirm] when the last digit of the Bluetooth PIN is highlighted.

The message <BT PIN changed> appears for 3 s on the display.



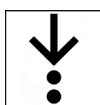

12.13 Factory Settings

At user level OPERATOR, the user can reset the settings of the arm to factory settings (see 10 Factory Settings on page 78).

To reset settings to factory settings, proceed as follows:





1. Confirm the confirmation dialogue (see 7.3.3 Confirmation Dialogues on page 43).
A green confirmation tick indicates that resetting to factory settings was successful. The screen switches to the menu "System".

-  A red X-symbol indicates that the procedure failed.
-  After resetting to factory settings, it is not necessary to save the settings.
-  When resetting to factory settings, the PINs for Bluetooth, OPERATOR and DEFAULT are reset.
-  When resetting to factory settings, the usage selection will be reset to "ADVANCED".
-  When resetting to factory settings, the list of paired devices will be deleted. These devices must be paired again.

12.14 Update

The user can import updates of the arm software using the SD card (see 5.5.3 SD Card on page 26).

-  The update can only be installed if the SD card is inserted.
-  The update file must be named "cCPR-update.pck" and be located in the /update folder on the SD card.
-  When updating the device, the list of paired devices will possibly be deleted. These devices must be paired again.

NOTICE!

Cancellation of the update!

Can lead to irreparable failure of the arm.

- ▶ Do not switch off the arm while the update is in progress.
- ▶ The battery charging status must correspond to at least three lit LEDs.
- ▶ Do not remove the battery while the update is in progress.
- ▶ During the update, connect the arm to a power supply.

To install the update, proceed as follows:



Prerequisite:

- ✓ An SD card with a valid update file is inserted in the SD card slot (see 6.3 Inserting the SD Card on page 35)
1. Confirm the confirmation dialogue (see 7.3.3 Confirmation Dialogues on page 43).
The system checks the update file.

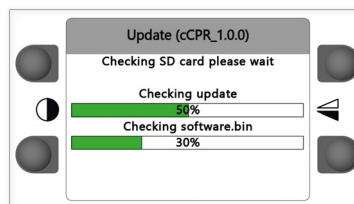

Fig. 12-18 Update check

2. Start the update using the softkey [START].

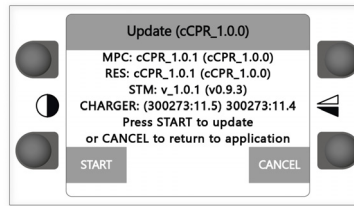

Fig. 12-19 Update - version overview



To cancel the action, press softkey [CANCEL]. The arm performs a restart.

The update starts.

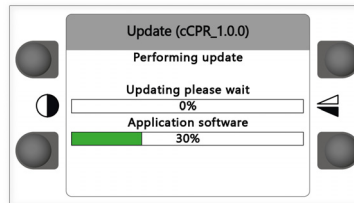

Fig. 12-20 Update process

The display indicates that the update has been successful.

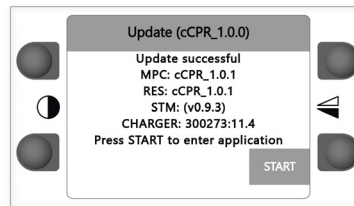

Fig. 12-21 Update successful

The update has been performed.



3. Restart the arm using the softkey [START].
The arm performs a restart.



After every update, a functional test must be carried out for the arm (see 16.4 Functional Test on page 114).

The following table shows the error messages possible during an update and describes:

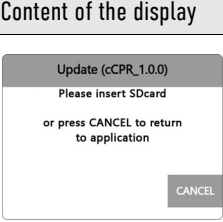
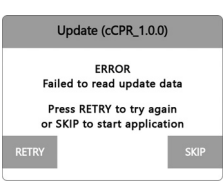
- The causes of the fault
- The possible consequences
- The measures to be taken to eliminate the fault

Content of the display	Cause	Consequences	Measure
	SD card not found	Update not possible	<ul style="list-style-type: none"> Insert an SD card with an update file into the SD card slot
	Update file read error	Update not possible	<ul style="list-style-type: none"> Check the SD card and the update file
	No update file found on the SD card	Update not possible	<ul style="list-style-type: none"> Save the update file to the SD card

Tab. 12-1 Update errors

13 Therapy and Transport with the Recboard

This chapter instructs the user on how to use the Recboard, Straps and the Fixation Ring for therapy and patient transport.

13.1 Warnings



WARNING!

Displacement of therapy zone when transporting the patient sitting up!

Therapy during transporting the patient sitting up can lead to severe internal injuries of the patient with ineffective therapy.

- ▶ Implement the transport with the patient sitting up as flat as possible.
- ▶ Continually check the correct pressure position.

13.2 Therapy with the Recboard

Assembly of the arm and therapy using the Recboard corresponds to assembly and therapy using the Quadboard (see 9 Therapy on page 65). The Recboard can be used in four different positions underneath the patient. The following illustrations describe the four possible orientations.

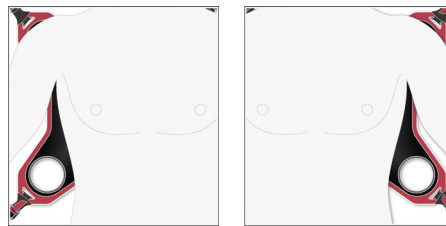

Fig. 13-1 Recboard aligned above shoulders



In the case of obese patients, the manufacturer recommends aligning the Recboard above the shoulders. When aligning beside the thorax, the maximum thorax width of the patient is limited to 48 cm.

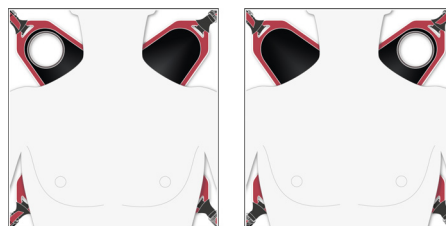

Fig. 13-2 Recboard aligned beside thorax



The user is responsible for the appropriate alignment of the Recboard underneath the patient.

13.3 Transport with the Recboard

In combination with an appropriate transport device and patient securing system, it is possible to transport the patient with the Recboard while therapy is in progress.



An appropriate head restraint must be used during transport.



The user is responsible for a sufficient fixation and has to use additional means of fixation, if necessary.

To transport the patient using the Recboard, proceed as follows:



Prerequisite:

- ✓ The patient has been positioned on the Recboard while therapy is in progress
1. Stop therapy (see 9.5.2 Starting, Stopping/Pausing and Resuming Therapy on page 74).
 2. Position the patient together with the Recboard on the transport device.



CAUTION!

Inadvertent commencement of therapy while repositioning the patient!

Can lead to patient or user injury.

- ▶ Do not press the **Start/Stop** key before the arm has been adjusted.
- ▶ Take special care to avoid unintended pressing of the **Start/Stop** key.



Grip and lift the Recboard with the patient using the hand loops of the attachment straps.



The user is responsible for choosing the appropriate method of positioning the patient with the Recboard on the transport device in accordance with the type of transport device used.

3. Check the arm and stamp positions and adjust where required (see 9.3.5 Adjusting the Arm on page 69) (see 9.3.6 Stamp Position Check on page 70).

The arm is adjusted and the stamp is positioned above the therapy zone (see Fig. 9-5 Adjusting the arm in the therapy zone on page 70).

4. Start therapy (see 9.5.2 Starting, Stopping/Pausing and Resuming Therapy on page 74).
5. Fixate the Recboard on the transport device with the safety straps.



Use the available recessed grips and eyelets at the transport device.



Fig. 13-3 Recboard on transport device



The user is responsible for proper and secure positioning of the Recboard on the transport device.

Recboard is fixated on the transport device.

6. Secure the patient on the transport device using the Straps and a suitable head restraint (see 13.4.1 Securing the Patient with Straps on page 104).

The patient is ready for transport.



As long as there is no mechanical thorax compression, CPR must be performed manually.



Suitable transport devices include standard commercial spine boards or stretchers, which are not part of the corpuls cpr system. The manufacturer recommends a flat spineboard for patient transport.

13.4 Patient Securing System

Use the fixation systems Straps and Fixation Ring only to secure adult patients.

The selection of the right securing system depends on the used transport device.

- The height of the patients is sufficient to have them secured on, among others, spineboards or stretchers
- Patients have to be secured on Recboard or Scoopboard for transport, among others, with rescue sheets or vacuum mattresses

13.4.1 Securing the Patient with Straps

The user can secure the patient for transport using the Straps. This chapter instructs the user how the Straps work and how to use them.

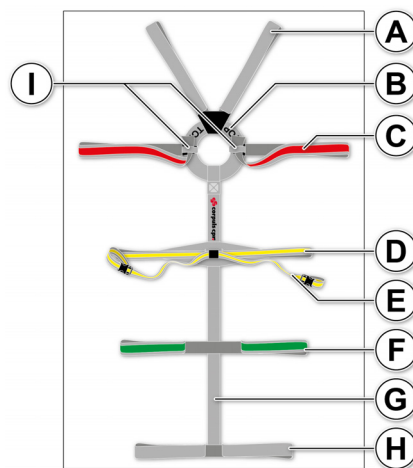

Fig. 13-4 Straps

Item	Component	Description
A	Grey shoulder strap	Immobilises the patient in the shoulder area.
B	Chest ring	Allows therapy to be performed on the secured patient through the round opening.
C	Red chest strap	Immobilises the patient in the chest area.
D	Yellow pelvic strap	Immobilises the patient in the pelvic area.
E	Hand loops	Immobilise the hands of the patient near the body. The hand loops can be removed.
F	Green leg strap	Immobilises the patient in the leg area.
G	Sagittal band	Centers the Straps on the patient.
H	Grey foot strap	Immobilises the patient in the foot area.
I	Velcro fasteners	Secure the overlapping ends of the red chest strap.

Tab. 13-1 Straps

**CAUTION!**

Patient not secured due to damaged Straps!

Can lead to patient injury during transport, if the patient is secured with damaged Straps.

- ▶ Use the Straps only to secure the patient.
- ▶ Do not use the Straps as carrying or lifting equipment.
- ▶ Only use non-damaged Straps to secure the patient.

**CAUTION!**

Therapy stamp in movement!

Can cause crush injuries to the user.

- ▶ Do not reach under the moving stamp.



To attach the Straps, the user needs a helper. All steps should be performed simultaneously on both sides of the patient.

To secure the patient for transport using the Straps, proceed as follows:

Prerequisite:

- ✓ The patient has been positioned on a suitable transport device
- ✓ The Recboard is placed between the transport device and the patient and is secured to the transport device with the straps

1. Place the Straps with the sagittal band (item G) on the middle of the patient's body.

The label TOP and the corpuls cpr lettering must face upwards.



2. Pause the therapy.
3. Position the chest ring (item B) beneath the stamp.
4. Continue therapy.
5. Position the grey shoulder strap (item A) at the head of the patient.
6. Position the grey foot strap (item H) at the feet of the patient.
7. Position the yellow pelvic strap (item D) at the pelvic area.
8. Place the grey shoulder strap (item A) on both sides over the shoulders of the patient.
9. Thread the grey shoulder strap (item A) through the lowest reachable recessed grip towards the pelvic area.
10. Position the grey shoulder strap (item A) back over the shoulders of the patient and secure.
11. Position the grey foot strap (item H) and secure through the lowest reachable recessed grip.
12. Thread the red chest strap (item C) at the upper body under the armpits of the patient towards the head.
13. Thread the red chest strap (item C) through the highest reachable recessed grip and secure.



To prevent the protruding ends of the red chest straps entering the therapy area, use the Velcro fasteners.

14. Position the yellow pelvic strap (item D) over the pelvis of the patient and secure.
15. Position the green leg strap (item G) over the thighs of the patient and secure.
16. Re-tighten the grey shoulder strap (item A) and the red chest strap (item C).
17. Attach the head restraint.

18. Immobilise the wrists of the patient with the hand loops (item E).
The patient is immobilised on an appropriate transport device and secured for transport.

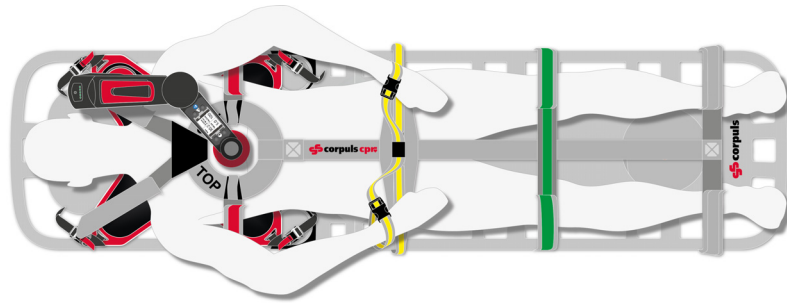

Fig. 13-5 Securing the patient



The user is responsible for checking the correct placement of the Straps.



The user is responsible for checking the correct placement of the chest ring during therapy.



In the case of trauma, steady the patient's head with your hands until the head restraint has been mounted.

13.4.2 Securing with the Fixation Ring

The following section explains the use of the Fixation Ring with the example of patient transport with a rescue sheet.



The manufacturer recommends a rescue sheet with a foot bag for patient transport.



The user needs 3 helpers to put the patient with the Recboard onto the rescue sheet.



To secure the patient for transport using the Fixation Ring, proceed as follows:

Prerequisite:

- ✓ The patient has been positioned on the Recboard while therapy is in progress
- ✓ The attachment straps are fastened to the Recboard, closed to form hand loops and freely accessible

1. Prepare the rescue sheet beside the patient.



The foot bag of the rescue sheet has to be beside the feet of the patient.

2. Pause the therapy.
3. Move the Recboard with the patient on to the rescue sheet by means of the hand loops.



The manufacturer recommends that the user and one helper grasp two hand loops each. The remaining helpers lift the head and the legs of the patient.

Patient with Recboard lies on the rescue sheet.

4. Position the Fixation Ring centrally on the thorax of the patient and hold to keep in place.



The opening of the Fixation Ring has to keep the therapy zone of the stamp free.

5. Check the arm and stamp positions and adjust where required (see 9.3.5 Adjusting the Arm on page 69) (see 9.3.6 Stamp Position Check on page 70).

The arm is adjusted and the stamp is positioned above the therapy zone.

6. Continue therapy.



CAUTION!

Therapy stamp in movement!

Can cause crush injuries to the user.

- ▶ Do not reach under the moving stamp.

7. Open the hand loops of the attachment straps.
8. Fasten the Fixation Ring with the attachment straps of the Recboard.



Fig. 13-6 Fitting the fixation ring



The manufacturer recommends to keep the Fixation Ring in position while helpers pull tight the attachment straps at carefully and evenly.



The manufacturer recommends to secure the arms of the patient close to the body with the attachment straps.

The patient can no longer slip on the Recboard.

9. Put the feet of the patient into the foot bag.

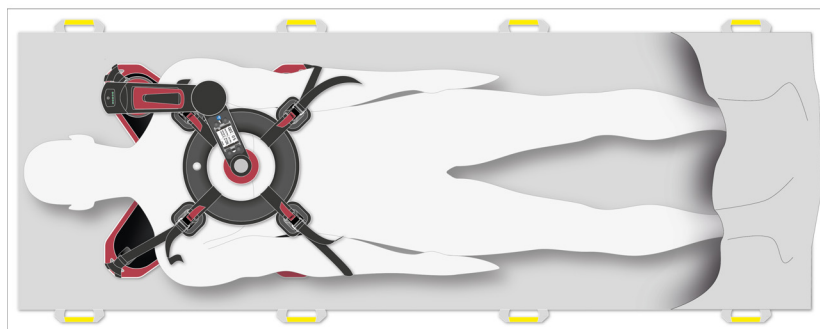

Fig. 13-7 Patient secured with the fixation ring

The patient lies on the rescue sheet and is ready for transport.



The user is responsible for checking the correct placement of the Fixation Ring and the stamp position during therapy.



As long as there is no mechanical thorax compression, CPR must be performed manually.

14 Therapy and Transport with the Scoopboard

This chapter instructs on how to use the Scoopboard for therapy and patient transport.

14.1 Warnings

NOTICE!

Damage due to tilting!

If the arm is assembled on the Scoopboard with no patient on it, the board can tilt over and damage the corpuls cpr and its accessories.

- ▶ Only assemble the arm of the corpuls cpr on a Scoopboard with a patient on it. When assembling without a patient, e.g. for the daily functional test, support the Scoopboard with your hand.

NOTICE!

Improper removal of stamp extension!

Can lead to damage of the device.

- ▶ Hold the stamp column and pull the stamp extension carefully downwards with a slight turning motion.
- ▶ Remove the stamp extension with the arm switched on.

14.2 Therapy with the Scoopboard

Assembly of the arm on the Scoopboard corresponds to assembly on the Quadboard (see 9.3 Preparing Therapy on page 66). The Scoopboard has been developed specifically for use in combination with scoop stretchers.

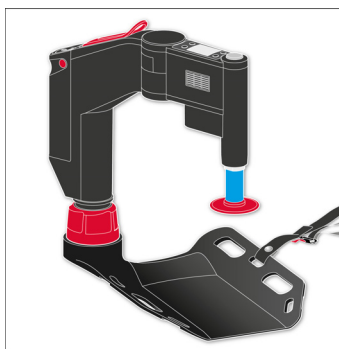

Fig. 14-1 Scoopboard with stamp extension



WARNING!

Jeopardized therapeutic success due to delayed therapy!

To reach the required compression depth, there may be avoidable re-adjustments of the arm with the use of the Scoopboard.

- ▶ When performing therapy with the Scoopboard always insert the stamp extension.



The manufacturer recommends to remove the stamp extension when changing boards.



To put the patient on the Scoopboard, the user needs several helpers.



To place the Scoopboard beneath the patient, proceed as follows:

1. The user and the helpers roll the patient on his side.
2. The Scoopboard is positioned at the back of the patient.



The Scoopboard can be used in only one position underneath the patient. The socket for the arm should be located besides the head and above the right shoulder of patient.

3. Roll back the patient together with the Scoopboard.
The Scoopboard is positioned under the patient.
4. Assemble the arm.
5. Adjust the arm and start therapy (see 9 Therapy on page 65).
The patient has been positioned on the Scoopboard while therapy is in progress.



The user is responsible for choosing a suitable method to put the patient on the Scoopboard.

14.3 Transport with the Scoopboard

Due to the form of the Scoopboard, use with curbed transport devices such as scoop stretchers is possible and allows transport during therapy in combination with the attachment straps and the Fixation Ring (see 5.5.8 Fixation Ring on page 28). In the following, the procedure for transport with a scoop stretcher and a vacuum mattress is explained.

To transport the patient using the Scoopboard, proceed as follows:



Prerequisite:

- ✓ The patient has been positioned on the Scoopboard while therapy is in progress
- ✓ The attachment straps are fastened to the Scoopboard and freely accessible

1. Pause the therapy (see 9.5.2 Starting, Stopping/Pausing and Resuming Therapy on page 74).
2. Position the Fixation Ring centrally on the thorax of the patient and hold to keep in place.



The opening of the Fixation Ring has to keep the therapy zone of the stamp free.

3. Check the arm and stamp positions and adjust where required (see 9.3.5 Adjusting the Arm on page 69) (see 9.3.6 Stamp Position Check on page 70).
The arm is adjusted and the stamp is positioned above the therapy zone.
4. Continue therapy.



CAUTION!

Therapy stamp in movement!

Can cause crush injuries to the user.

- ▶ Do not reach under the moving stamp.

5. Fasten the Fixation Ring with the attachment straps of the Scoopboard (see 13.4.2 Securing with the Fixation Ring on page 106).



The manufacturer recommends to keep the Fixation Ring in position while helpers pull tight the attachment straps at carefully and evenly.



The manufacturer recommends to secure the arms of the patient close to the body with the attachment straps.

The patient can no longer slip on the Scoopboard.



Fig. 14-2 Patient secured with the fixation ring

6. Open the scoop stretcher and bring it together beneath the Scoopboard.
7. Close both halves of the scoop stretcher.
8. Secure the patient for transport with the securing system of the scoop stretcher.
The patient can be transferred during therapy to the vacuum mattress by means of the scoop stretcher.



The user is responsible for checking the correct placement of the Fixation Ring and the stamp position during therapy.



As long as there is no mechanical thorax compression, CPR must be performed manually.

15 External Battery Charger

15.1 Intended Use of External Battery Charger

The external battery charger allows to charge the battery of the corpuls cpr.



The manufacturer recommends to leave a replacement battery of the corpuls cpr in the external battery charger connected to a power supply. The performance of the battery is not impaired by this.

15.2 Intended Use of the External Battery Charger

The following points must absolutely be observed to comply with the intended use:

- The user must have read and understood the user manual
- The external battery charger is used exclusively to charge the battery of the corpuls cpr
- The user exclusively uses the corpuls cpr AC adapter (see 5.5.1 AC Adapter on page 25) or the corpuls cpr DC connector cable to connect to a power supply (see 5.5.2 DC Connector Cable on page 25)

The external battery charger can be operated either as permanently installed as wall-mounted charger or as stationary desktop charger.



When used as wall-mounted charger, make sure to correctly secure the device according to the supplied assembly instruction.



The use as wall-mounted charger is possible in mobile rescue vehicles as well as in closed rooms.



The external battery charger is intended for operation in a humid environment, corresponding to protection class IP X3. Do not expose the external battery charger to water splashes or -jets.

15.3 Operation Statuses

The operating status of the external battery charger is signalled via the status LED at the device. The state of charge of the battery can be read from the LEDs of the battery display.

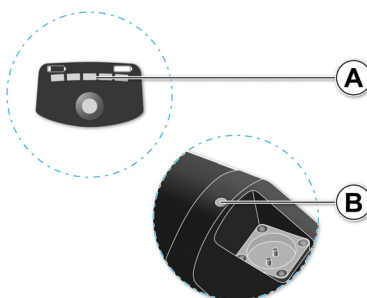

Fig. 15-1 Operating status of the external battery charger

Item	Component	Description
A	LEDs of the battery display	The following displays are available: <ul style="list-style-type: none"> • Battery charging status • Charging process of the battery • Battery alarms
B	LED of the status display	LED for displaying the status of the external battery charger.

Tab. 15-1 Operating status of the external battery charger

15.3.1 Operational Status

If the external battery charger is connected to a power supply without a battery inserted, a slow flashing of the LED in green signals the operational status of the device.

15.3.2 Error Status

An error in the external battery charger is signalled by an orange glow / flashing of the status display.

15.4 Charging with the External Battery Charger

To charge the battery with the external battery charger, proceed as follows:



Prerequisite:

- ✓ The external battery charger is connected to a power supply intended for that purpose (see 6.2.2 Charging the Battery on page 33) and a visual check has made sure that the battery and battery shaft are clean

1. Insert the battery.

An acoustic signal is sounding.



The charging process starts automatically. The LEDs of the battery are flashing, the status display of the external battery charger flashes rapidly. The number of flashing LEDs at the battery corresponds to the current battery charging status.



If the battery is fully charged, the LED of the external battery charger is glowing permanently. The status display of the battery is deactivated.



Do not touch the charging contacts and the patient simultaneously.



If the power supply is interrupted during the charging process, the device emits several acoustic warning signals.



Do not cover the external battery charger during operation to prevent heat accumulation.

15.5 Battery Removal

The removal of the battery from the external battery charger is done analogously to the removal from the arm (see 6.2.3 Changing the Battery on page 34).

15.6 Disconnecting from the Mains

To disconnect the external battery charger from the mains, the magnetic connector of the supply cable has to be removed. When installing the external battery charger, make sure that the connector is always easily accessible.

16 Functional Test and Maintenance

Regular functional testing and maintenance guarantee unrestricted function and operability of the device. This can prevent electrical and mechanical faults or identify them in a timely fashion.

16.1 Warnings

The following warnings inform the user of possible hazards for this chapter.



WARNING!

Limited functionality due to device malfunctions!

Can result in the device no longer functioning correctly.

- ▶ If faults cannot be repaired, contact your authorised service and sales partner.
- ▶ Do not use the device on patients.
- ▶ If necessary, take device out of commission.



The complete corpuls cpr system, comprised of an arm and the board used, must be taken into consideration during all test and maintenance measures.

16.2 Intervals

The following table provides an overview of the intervals at which to perform the functional test and maintenance measures.

Intervals	Functional test	Maintenance
Initial start-up	x	
Daily/per shift	x	
After use*	x	
As required *	x	
Annually		x
If faulty	x	x

Tab. 16-1 Intervals - Functional test and maintenance

*Manufacturer's recommendation

16.3 Selftest

While powering up is in progress, the arm carries out a self-test. The functional test includes a complete system check of all critical components. If there are malfunctions during the system check, these are listed on the arm display (see 16.4 Functional Test on page 114).

16.4 Functional Test





The functional test is aimed at testing the device functions. If the correct result is obtained for all steps, the functional test is considered a pass. The manufacturer recommends logging the functional test using a checklist.

NOTICE!

Damage due to tilting!

Can tilt over in assemble state without a patient and damage the corpuls cpr and its accessories.

- ▶ Do not transport the corpuls cpr before it has been assembled. When assembling without a patient, e.g. for the daily functional test, support the board with your hand.
-

Step	Task	Result
1	Check the corpuls cpr and its accessories for damage (visual check).	<ul style="list-style-type: none"> The corpuls cpr and its accessories are not visibly damaged.
2	Check the charging status of the battery and reserve battery (see 6.2 Checking the Battery on page 32).	<ul style="list-style-type: none"> At least 4 LEDs of the battery display light up.
3	Check whether an SD card is inserted (see 6.3 Inserting the SD Card on page 35).	<ul style="list-style-type: none"> An SD card is inserted
4	Assemble the arm with the battery inserted on the board (see 9.3.3 Assembling the Arm on page 67).	<ul style="list-style-type: none"> The arm locks easily into the socket of the board The arm is securely connected to the board
5	Release the locking lever.	<ul style="list-style-type: none"> The arm is easy to move and does not lock
6	Close the locking lever.	<ul style="list-style-type: none"> All moveable parts of the arm are fixed.
7	Check the stamp for stress whitening and insert stamp (see 6.4 Inserting the Stamp on page 36).	<ul style="list-style-type: none"> The stamp clicks into position.
8	Switch on the arm (see 9.3.4 Switching On the Arm on page 68).	<ul style="list-style-type: none"> The self-test starts The screen is illuminated The Start/Stop key flashes white and a short acoustic signal is emitted. The arm does not signal any alarm. The main screen or a start screen appears
9	Perform stamp position check.	
	a) Open the locking lever.	<ul style="list-style-type: none"> The LED of the Start/Stop key lights up yellow The display shows the symbol 
	b) Press the stamp gently inwards.	<ul style="list-style-type: none"> The LED of the Start/Stop key lights up green The display shows no symbol
	c) Press the stamp firmly inwards.	<ul style="list-style-type: none"> The LED of the Start/Stop key lights up red The display shows the symbol 
	d) Release stamp.	<ul style="list-style-type: none"> The LED of the Start/Stop key lights up yellow The display shows the symbol 
	e) Start therapy (check safety function) (see 9.5.2 Starting, Stopping/Pausing and Resuming Therapy on page 74).	<ul style="list-style-type: none"> Therapy does not start The display shows the symbol 
	f) Close the locking lever.	<ul style="list-style-type: none"> The symbol  disappears from the display.
	g) Start therapy.	<ul style="list-style-type: none"> The arm performs compressions in the configured mode**
10	Switch off the arm (see 9.6 Switching Off the Arm on page 75).	<ul style="list-style-type: none"> The arm does not signal any alarm. The arm is switched off
The daily functional test is finished.		

Tab. 16-2 Daily functional test

*The stamp is intended for repeated use. The user must replace the stamp immediately if stress whitening occurs. Stress whitenings are fine cracks in the material which typically occur on the stamp surface. If the user does not replace the stamp in case of stress whitening, the stamp can break along these cracks and injure the patient. Nevertheless during the daily functional test, the user must check the stamp for damage such as white material discolouration or cracks and replace it if necessary.

** Thorax compression devices can cause various operation noises due to different of compression rate levels. Squeaking noises are in general normal operation noises of the corpuls cpr.

In case of deviating results of the daily functional test, the user may not operate the corpuls cpr.

In case of deviating results, the user has to proceed as follows:

- Deviating result in step 5: Charge the battery or reserve battery
- Deviating result in step 6: Insert the SD card
- In case of all other deviating results, the user must contact an authorised sales and service partner immediately

16.5 Regular Maintenance Work

Maintenance works are to be performed exclusively by authorised sales and service partners. Maintenance work performed by non-authorised sales and service personnel can result in damage to the corpuls cpr and loss of warranty claims at GS Elektromedizinische Geräte G. Stemple GmbH.



In order to prevent transport damage when shipping the device, the original packaging must be used. If the original packaging is no longer available, use appropriate packaging. This appropriate packaging must guarantee safe transport of the device.

The maintenance intervals can be found in the overview of test and maintenance intervals (see Tab. 16-1 Intervals - Functional test and maintenance on page 114).

A maintenance check is mandatory for:

- Arm, including battery provided
- Quadboard
- Recboard
- Scoopboard

17 Cleaning and Disinfection

This chapter describes the reprocessing of the corpuls cpr and its accessories through cleaning and disinfection.

17.1 Warnings



CAUTION!

Touching hot parts!

Can cause injury to the user as a result of burns.

- ▶ Ensure that the arm cools down sufficiently after use.



CAUTION!

Chemical interaction due to use of different disinfection agents!

Can lead to user injury.

- ▶ Do not mix cleaning or disinfecting liquids.



CAUTION!

Reduced effectiveness or cancellation of the cleaning/disinfection effect!

Can lead to cross contamination as well as user and patient injury.

- ▶ Only use fresh water of at least drinking quality.
- ▶ Mind the manufacturer's indications of cleaning-, disinfecting- and reprocessing agents (compatibility, concentration, exposure time, temperature and change of cleaning- or disinfecting agent, use of personal protective wear).
- ▶ Before first commissioning the device and after every application or use, all used components must be reprocessed.
- ▶ The respective accepted standards of hygiene for handling and disinfecting equipment contaminated with bodily fluids must be observed.
- ▶ The local regulations for disposal of infectious waste and materials contaminated with bodily fluids must be followed.
- ▶ If there is a suspected risk of contamination of the device with dangerous pathogens, contact your authorised sales and service partner, as it may be necessary to process the insides of the device with disinfectants.
- ▶ Only use disinfecting agents that are approved nationally and suited for the respective reprocessing methods (e.g. RKI list).

NOTICE!

Damage to the corpuls cpr as a result of incorrect cleaning and disinfection!

Can damage the material of the corpuls cpr and of its accessories, restrict their function, or nullify the effect of cleaning and disinfection.

- ▶ Do not immerse the corpuls cpr and its accessories in liquids and cleaning- or disinfecting agents.
- ▶ Do not let fluids penetrate into the interior of electrical devices and into the plug connections.
- ▶ To remove coarse dirt or stains exclusively use clean, soft and lint-free cloths.
- ▶ Do not use microfibre cloths.
- ▶ Do not clean/disinfect the corpuls cpr and its accessories by machine and do not sterilise them in an autoclave, under pressure or with gas.

NOTICE!

Damage to the corpuls cpr as a result of using an incorrect disinfectant!

Can damage the material of the corpuls cpr and of its accessories or restrict their function.

- ▶ Do not use disinfectants based on the following active ingredients:
 - Alkyl amine compounds
 - Phenolic compounds
 - Halogen-releasing compounds
 - Strong organic acids
- ▶ Make sure to use active substances belonging to the same group and keep in mind the maximum concentrations for use (see 17.2 Disinfectants on page 119).
- ▶ Check the fundamental suitability of disinfecting agents for cleaning or disinfection of instruments made from metal or plastics.
- ▶ Do not use disinfectants based on pure alcohol. Alcohol-based disinfectants or disinfectants containing high alcohol concentrations have only limited effectiveness and can lead to damage of the material.



The manufacturer also points out that oxygen- and chlorine releasing agents can lead to discolourations in some materials. Discolourations do not impair the functionality of the product.

17.2 Disinfectants

The following disinfectants of PAUL HARTMANN AG (Bode Chemie) have been tested by the manufacturer and are recommended for effectiveness and product specific material compatibility:

Disinfectants	Active ingredients	CAS No.	Max. application concentration % (m/m)
Mikrobac[®] Virucidal Tissues	Quaternary ammonium compounds	7173-51-5	0.25
		68391-01-5	0.25
	Aminoalcohols	141-43-5	1
Bacillo[®] Sensitive 30	Alcohols	71-23-8	10
		67-63-0	20
		64-17-5	20
	Surfactant	139734-65-9	0.25
Dismozon[®] plus	Peroxide	84665-66-7	100
	Fatty alcohol	69011-36-5	2.5
	Amine	308062-28-4	2.5
Kohrsolin[®] FF	Aldehyde	111-30-8	10
	Surfactants	69011-36-5	10
		68439-50-9	10
	Quaternary ammonium compounds	7173-51-5	5
		68391-01-5	5
	Alcohol	67-63-0	3
Mikrobac[®] Forte	Quaternary ammonium compound	68391-01-5	20
	Amine	2372-82-9	5
	Surfactants	69011-36-5	3
		68439-50-9	2.5

Tab. 17-1 Overview of recommended disinfectants



If the user utilises other disinfecting agents, responsibility lies with the user.

17.3 Intervals

The following table provides an overview of the intervals at which to perform cleaning and disinfection measures.

Intervals	Cleaning and Disinfection
Initial start-up	x
Daily/per shift	
After use	x
As required *	x
Annually	
If faulty	

Tab. 17-2 Intervals - Cleaning and Disinfection

*Manufacturer's recommendation

17.4 Cleaning and Disinfection Procedure

To clean and disinfect the corpuls cpr and its accessories, proceed as follows:

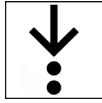

Prerequisite:

- ✓ The arm is switched off and the stamp removed (see 9.6 Switching Off the Arm on page 75) (see 9.7 Removing the Stamp on page 76)
- ✓ All surfaces of the corpuls cpr and its accessories that are to be cleaned and disinfected are freely accessible
- ✓ For all cleaning-, disinfection- and postprocessing steps respectively, a clean, lint-free cloth soaked in disinfecting agent is available.

1. Pre-clean all surfaces of the corpuls cpr manually with a clean, lint-free cloth soaked in disinfecting agent and remove all coarse dirt.
2. Clean the corpuls cpr manually.
 - a) Distribute the disinfecting liquid with wiping motions on the surface. Make sure the surface is wetted evenly and completely, if necessary use several cloths per cleaning.
 - b) Press a clean, lint-free cloth soaked in disinfecting agent into the recesses and grooves of the outer housing, so that less accessible outer surfaces are also wetted thoroughly with disinfecting agent.
 - c) Keep on cleaning until all visible dirt or stains are removed and the entire surface has been wetted with disinfecting agent. Pay particular attention to hand contact points and device surfaces that are often touched.
3. Disinfect the corpuls cpr manually.
 - a) Distribute the disinfecting liquid with wiping motions on the surface. Make sure the surface is wetted evenly and completely, if necessary use several cloths per cleaning.
 - b) Press a clean, lint-free cloth soaked in disinfecting agent into the recesses and grooves of the outer housing, so that less accessible outer surfaces are also wetted thoroughly with disinfecting agent.
 - c) Keep on disinfecting until the entire surface has been wetted with disinfecting agent. Pay particular attention to hand contact points and device surfaces that are often touched.
4. Postprocess the corpuls cpr

After the application time of the disinfecting agent has expired, wipe down the surfaces with a clean, lint-free cloth soaked in water. The water should be at least drinking quality. After wiping down, let the surfaces dry completely.



Postprocessing is only required, if this is indicated in the manufacturer's instructions of the respective disinfecting agent. Observe the application time of the disinfectant in accordance with the manufacturer's instructions.

The corpuls cpr and its accessories have been cleaned and disinfected.

After cleaning and disinfection, store the corpuls cpr protected from dust and moisture.



If the user detects visible damage after cleaning and disinfection, the user must not operate the corpuls cpr and has to contact an authorised sales and service partner.

17.4.1 Battery

To clean and disinfect the battery, proceed as follows:



1. Remove visible and coarse dirt from the battery (see 17.4 Cleaning and Disinfection Procedure on page 121).
2. Clean and disinfect the surfaces of the battery (see 17.4 Cleaning and Disinfection Procedure on page 121).

3. Allow the battery to dry.
4. Inspect the battery for visible damage.

17.4.2 Arm

The following section describes the preparation, cleaning and disinfection of the arm.

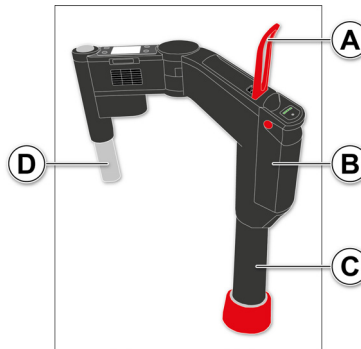

Fig. 17-1 Cleaning the arm

To clean and disinfect the arm, proceed as follows:



1. Preparing the arm for cleaning and disinfection:
 - a) Remove the arm from the board (see 9.8 Disassembling the Arm on page 76).
 - b) Switch off the arm (see 9.6 Switching Off the Arm on page 75).
 - c) Disconnect the arm from the power supply.
 - d) Remove the battery (item B) (see 6.2.3 Changing the Battery on page 34).
 - e) Release the locking lever (item A).
 - f) Remove the stamp (see 9.7 Removing the Stamp on page 76).
 - g) Remove stamp extension, if inserted.
2. Extend both columns.
 - a) Pull out the lifting column (item C).



CAUTION!

Touching hot parts!

Can cause injury to the user as a result of burns.

- Ensure that the arm cools down sufficiently after use.

- b) Pull out the stamp column (item D).
3. Remove visible and coarse dirt from the arm (see 17.4 Cleaning and Disinfection Procedure on page 121).
4. Clean and disinfect the surfaces of the arm (see 17.4 Cleaning and Disinfection Procedure on page 121).
5. Allow the arm to dry.
6. Prepare the arm for the functional test:
 - a) Insert stamp extension, if needed.
 - b) Insert stamp.
 - c) Press the lifting column inwards.
 - d) Close the locking lever.
 - e) Insert the battery.
 - f) Assemble the arm on the board.

7. Inspect the arm for visible damage and perform the functional test.



So that the stamp column is automatically retracted again, the arm must be switched on after cleaning and the locking lever then opened. The arm with inserted stamp only fits into the carrying bag with the stamp column retracted.

17.4.3 Stamp

To clean and disinfect the stamp, proceed as follows:



1. Remove visible and coarse dirt from the stamp (see 17.4 Cleaning and Disinfection Procedure on page 121).
2. Clean and disinfect the surfaces of the stamp (see 17.4 Cleaning and Disinfection Procedure on page 121).
3. Allow the stamp to dry.
4. Inspect the stamp for visible damage.

17.4.4 Stamp Extension

To clean and disinfect the stamp extension, proceed as follows:



1. Remove visible and coarse dirt from the stamp extension (see 17.4 Cleaning and Disinfection Procedure on page 121).
2. Clean and disinfect the surfaces of the stamp extension (see 17 Cleaning and Disinfection on page 118).
3. Allow the stamp extension to dry.
4. Inspect the stamp extension for visible damage.

17.4.5 Boards

To clean and disinfect the boards, proceed as follows:



1. Remove visible and coarse dirt from the boards (see 17.4 Cleaning and Disinfection Procedure on page 121).
2. Clean and disinfect the surfaces of the boards (see 17.4 Cleaning and Disinfection Procedure on page 121).
3. Allow the boards to dry.
4. Inspect the boards for visible damage.



If necessary, the straps of the boards must be cleaned separately in a washing machine and then disinfected. The manufacturer's cleaning and disinfection specifications are available at www.pax-bags.de/service/download.

17.4.6 Carrying Bags and Straps

The manufacturer's cleaning and disinfection specifications are available at www.pax-bags.de/service/download.

17.4.7 External Battery Charger

To clean and disinfect the external battery charger, proceed as follows:

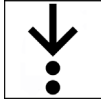

1. Remove visible and coarse dirt from the external battery charger (see 17.4 Cleaning and Disinfection Procedure on page 121).
2. Clean and disinfect the surfaces of the external battery charger (see 17.4 Cleaning and Disinfection Procedure on page 121).
3. Let the external battery charger dry.
4. Inspect the external battery charger for visible damage and perform the functional test.

Appendix

I Warranty

In addition to the statutory warranty conditions, the manufacturer offers a limited warranty on material defects and manufacturing faults. The scope of the warranty is described in the respective warranty conditions.

This warranty conclusively regulates the legal relationship between the purchaser and the manufacturer. Further damage claims are excluded, unless liability is prescribed by law.

The warranty does not cover wear parts, faults and damage as a result of improper use, incorrect setup or installation, extraneous causes such as transport damage, damage due to impact or jolts, or repairs and modifications carried out by an unauthorised third party.

The warranty claim shall also be void if unauthorised accessories are used, or if accessories or spare parts are used that were not provided by the manufacturer or an authorised sales and service partner. Software support (except updates) is not covered under the warranty.

In the event of a defect or a warranty claim, please contact an authorised sales and service partner or the manufacturer.

The manufacturer shall only accept responsibility for user and operating safety of the device if maintenance, maintenance checks, repairs, additions and reinstallations were performed by the manufacturer itself or by persons specifically authorised by the manufacturer.

Additionally, the valid version in each case of the manufacturer's general terms and conditions shall apply.

II Protection Rights and Patents

The device and certain accessories are protected by patents that are either pending and/or already granted. Consequently, possession or purchase of this device does not automatically confer licence to use this device with spare parts or accessories which, alone or in combination with this device, infringe applicable patents for this device or patents of individual components which are used with this device.

It is therefore not permitted to, e.g.:

- Dismantle parts of the device and use them for other purposes
- Replicate components or accessories

Goods are mentioned in this user manual without any mention of any existing patents, samples or trademarks.

corpuls[®] is a registered trademark of GS Elektromedizinische Geräte G.Stemple GmbH.

 GS is a registered trademark of GS Elektromedizinische Geräte G.Stemple GmbH.

The device as well as some of its accessories may be subject to one or more of the following, patent-protected inventions:

- U.S. patent N° 9,775,771
- U.S. patent N° 9,956,135
- and other patents

III Approved accessories and consumables

A list of approved accessories and consumables can be found at my.corpuls.world. For further information, advice and sales please contact an authorised service and sales partner.

IV Disposal



Do not dispose of the corpuls cpr or the accessories in household waste. Please ask your local authorities for information on correct disposal of the corpuls cpr and the accessories or return them to the manufacturer.



Dispose of the packaging of the corpuls cpr by means of your local institutions e.g. recovered paper container, recycling centre, paper collection etc.

V Technical Specifications

Patient parameters					
Thorax height		Short stamp		Long stamp	
		min.	max.	min.	max.
	Quadboard	19.3 cm	34.2 cm	13.3 cm	28.2 cm
	Recboard	18.4 cm	33.5 cm	12.8 cm	27.4 cm
	Scoopboard	18.6 cm	33.0 cm	12.6 cm	27.1 cm
Maximum thorax width	No restriction*				
Weight of the patient	No restriction				

Tab. 5-3 Technical specifications - patient parameters



* When assembling the arm besides the head of the patient (see 13.2 Therapy with the Recboard on page 102).

Therapy parameters	
Compression depth*	2 cm to 6 cm
	+/- 5 mm
Compression rate	80 1/min to 120 1/min
	+/- 2 1/min
Mode	30:2
	15:2
	cont.
Compression cycle (compression : release)	50 % : 50 %
	+/- 5 %

Tab. 5-4 Technical specifications - therapy parameters



* At a force greater than 600 N, the configured compression depth can deviate from the actual compression depth.

Dimensions		
Arm	Height	45 cm
	Width	43 cm
	Depth	9 cm
Arm, assembled on the Quad-board	Height	46 cm
	Width	49 cm
	Depth	49 cm
Battery	Height	20 cm
	Width	7 cm
	Depth	6 cm
Stamp, long	Height	9.8 cm
	Diameter	8.0 cm
Stamp, short	Height	3.8 cm
	Diameter	8.5 cm
Stamp extension	Height	9.5 cm
	Diameter	3.4 cm
Quadboard	Height	46 cm
	Width	46 cm
	Depth	10 cm
Recoboard	Height	47 cm
	Width	47 cm
	Depth	3.5 cm
Scoopboard	Height	45.8 cm
	Width	34.7 cm
	Depth	8.5 cm
Quadboard carrying bag, filled to capacity	Height	55 cm
	Width	50 cm
	Depth	24 cm
External battery charger	Height	9 cm
	Width	8 cm
	Depth	28 cm

Tab. 5-5 Technical specifications - Dimensions

Weight		
Arm (without battery)		4.7 kg
Battery	Li-Po	0.8 kg
	Li-Ion	0.6 kg
Stamp, long		50 g
Stamp, short		30 g
Stamp extension		100 g
Quadboard		1.7 kg
Recboard		2.2 kg
Scoopboard		1.7 kg
Carrying bag, filled to capacity		12.0 kg
External battery charger (incl. battery)		1.4 kg

Tab. 5-6 Technical specifications - weight

Storage and transport conditions		
Arm	Temperature	-30 °C to 70 °C
Quadboard	Humidity	max. 97 %
Recboard	Atmospheric pressure	616 hPa to 1060 hPa
Scoopboard		
Stamp		
Stamp extension		
Battery	Temperature	Min/max: -20 °C to 65 °C Typ. 10 °C to 35 °C
	Humidity	max. 97 %
	Atmospheric pressure	616 hPa to 1060 hPa
External battery charger	Temperature	-40 °C to 70 °C
	Humidity	max. 97 %
	Atmospheric pressure	616 hPa to 1060 hPa

Tab. 5-7 Technical specifications - Storage and transport conditions



The arm is immediately operational after storage. When used outside the specifications, the running time may be limited.

Environmental requirements		
Arm	Temperature	-20 °C to 45 °C
Quadboard	Transient temperature	-20 °C to 50 °C
Recboard	Humidity	max. 95 %
Scoopboard	Atmospheric pressure	616 hPa to 1060 hPa
External battery charger		
Stamp		
Stamp extension		
Battery		
	Temperature charge	0 °C to 45 °C
	Transient temperature	-20 °C to 50 °C
	Humidity	max. 95 %
	Atmospheric pressure	616 hPa to 1060 hPa

Tab. 5-8 Technical Specifications - Environmental requirements

Energy management and power output			
Internal power supply (battery) Capacity 3100 mAh Voltage range • Min. 24.0 V • Typ. 29.6 V • Max. 33.6 V	Version of the battery	Replaceable and chargeable lithium polymer (Li-Po) battery P/N 09120	Replaceable and chargeable lithium ion (Li-Ion) battery P/N 09120.1
	Capacity	3100 mAh	
	Voltage range	<ul style="list-style-type: none"> • Min. 24.0 V • Typ. 29.6 V • Max. 33.6 V 	
	Output current	4.5 A (for 500 ms)	5 A (for 500 ms)
Battery charging time at 20 °C ambient temperature in the arm (without therapy) or in external battery charger	Battery level	0 % to 80 %	<120 min
		80 % to 100 %	<60 min
Operating time of arm in battery operation	<ul style="list-style-type: none"> • Normal thorax • Compression depth 5.2 cm • Compression rate 100 /min • Mode: 30:2 		≥ 90 min
	In other thorax rigidities, the therapy duration can differ.		
DC connector cable Power consumption 120 W at 12 V/10 A Protection of the on-board power supply 15 A Length 2 m	Nominal voltage	12 V to 33 V	
	Power consumption	120 W at 12 V/10 A	
	Protection of the on-board power supply	15 A	
	Length	2 m	
AC Adapter Voltage, nominal 12 V Max. current 12.5 A	Output power, max.	150 W	
	Voltage, nominal	12 V	
	Max. current	12.5 A	
Maximal number of charging cycles 300			300
External battery charger Power consumption 120 W	Voltage supply	<ul style="list-style-type: none"> • Min. 10.8 V • Max. 33.0 V 	
	Power consumption	120 W	

Tab. 5-9 Technical data - Energy management and power output

General specification			
Screen	Type		2.4 " Blanview TFT LCD with LED backlight
	Definition	Horizontal	720 pixels
		Vertical	320 pixels
Volume	Operating volume		Max. 70 dB
	Volume of alarms		80 dB
Protection	Arm		IP54
	Battery		IP55
	External battery charger		IP33
Data interface			SD Card
Alarms			Audiovisual

Tab. 5-10 Technical specifications - general specifications

The following table describes the acoustic alarm signals of the arm.

Characteristic of alarm signal	High priority		Medium priority		Low priority		Reminder signal
	Medium priority		Low priority				
Number of tones of the tone pulse group	10		3		2		1
Pause between tone pulse groups	10 s		20 s		No repeat		60 s
Duration of a tone of the tone pulse group	90 ms		130 ms		190 ms		110 ms
Pause between the tones of the tone pulse group	1. - 2.	100 ms	1. - 2.	200 ms	1. - 2.	200 ms	n/a
	2. - 3.	100 ms	2. - 3.	200 ms	n/a		
	3. - 4.	290 ms	n/a				
	4. - 5.	100 ms					
	5. - 6.	1000 ms					
	6. - 7.	100 ms					
	7. - 8.	100 ms					
	8. - 9.	290 ms					
	9. - 10.	100 ms					

Tab. 5-11 Technical specifications - alarm signal

The following table describes the alarm signals of the LED of the **Start/Stop** key (see 5.2 Components of the Arm on page 21).

Characteristic of alarm signal		High priority	Medium priority	Low priority	Reminder signal
Colour of LED		Red	Yellow	Cyan	White
Duty cycle	Pulse duration	200 ms	800 ms	Permanent	20 ms
	Duration of pulse pause	250 ms	2000 ms	n/a	60 s

Tab. 5-12 Technical specifications - LED alarm signal

Bluetooth		
Version	Bluetooth Stack 2.0	
Bluetooth class (Emission/Transmission power)	Class 2	
Frequency band	2.4 GHz	
Effective radiated power according to IEC 60601-1-2	typ. 0 dBm = 1 mW	
Modulation type	FHSS	
Effective data rate	HF data rate	max. 704 kbps
	Interface data rate	9.6 kbps to 921.6 kbps
Security Protocol	Security Mode 2	
Authentication	Security Level 3	

Tab. 5-13 Bluetooth

VI Overview of Menu Navigation DEFAULT

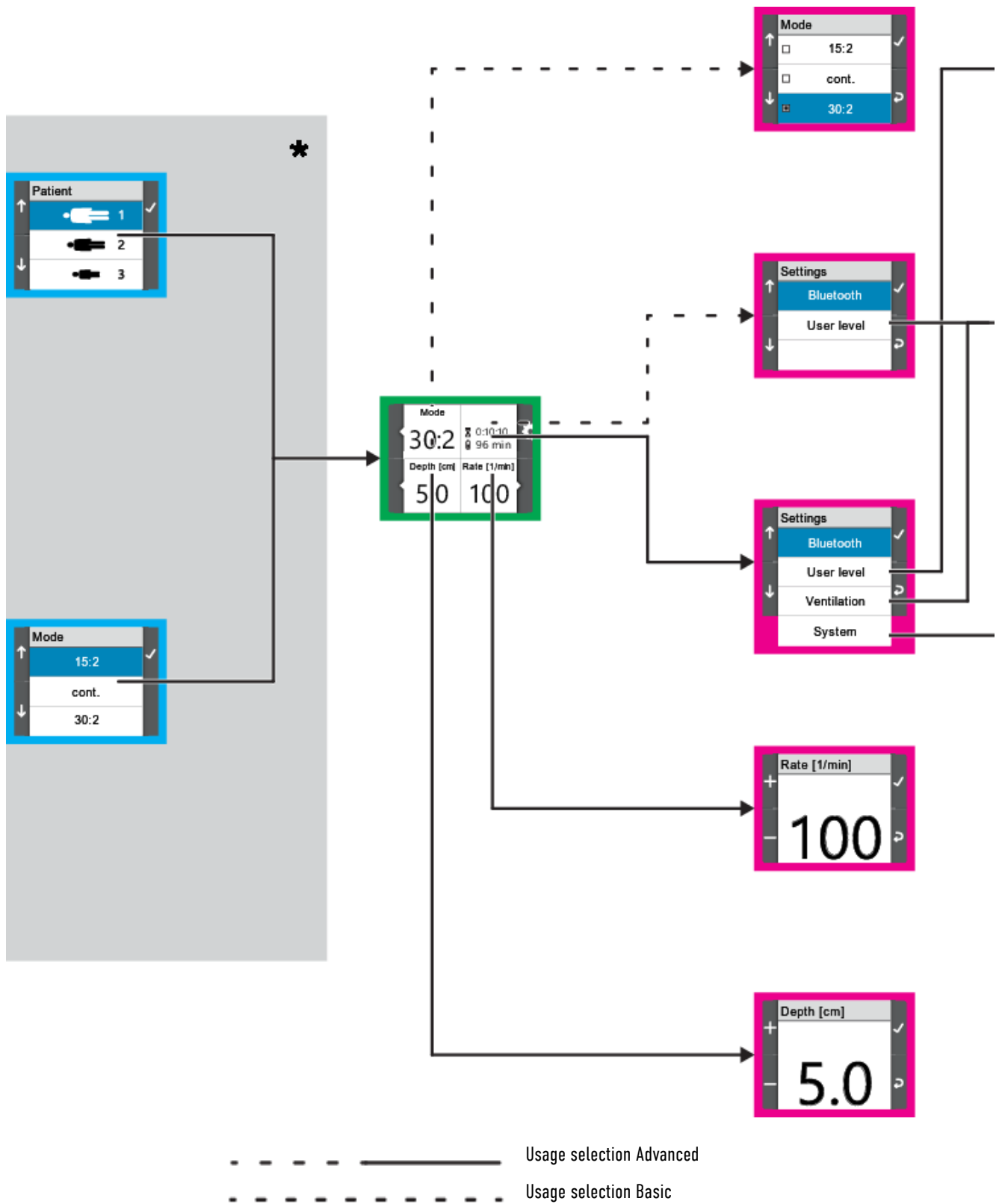

* Not active at first start with factory settings. Can be activated at user level OPERATOR.

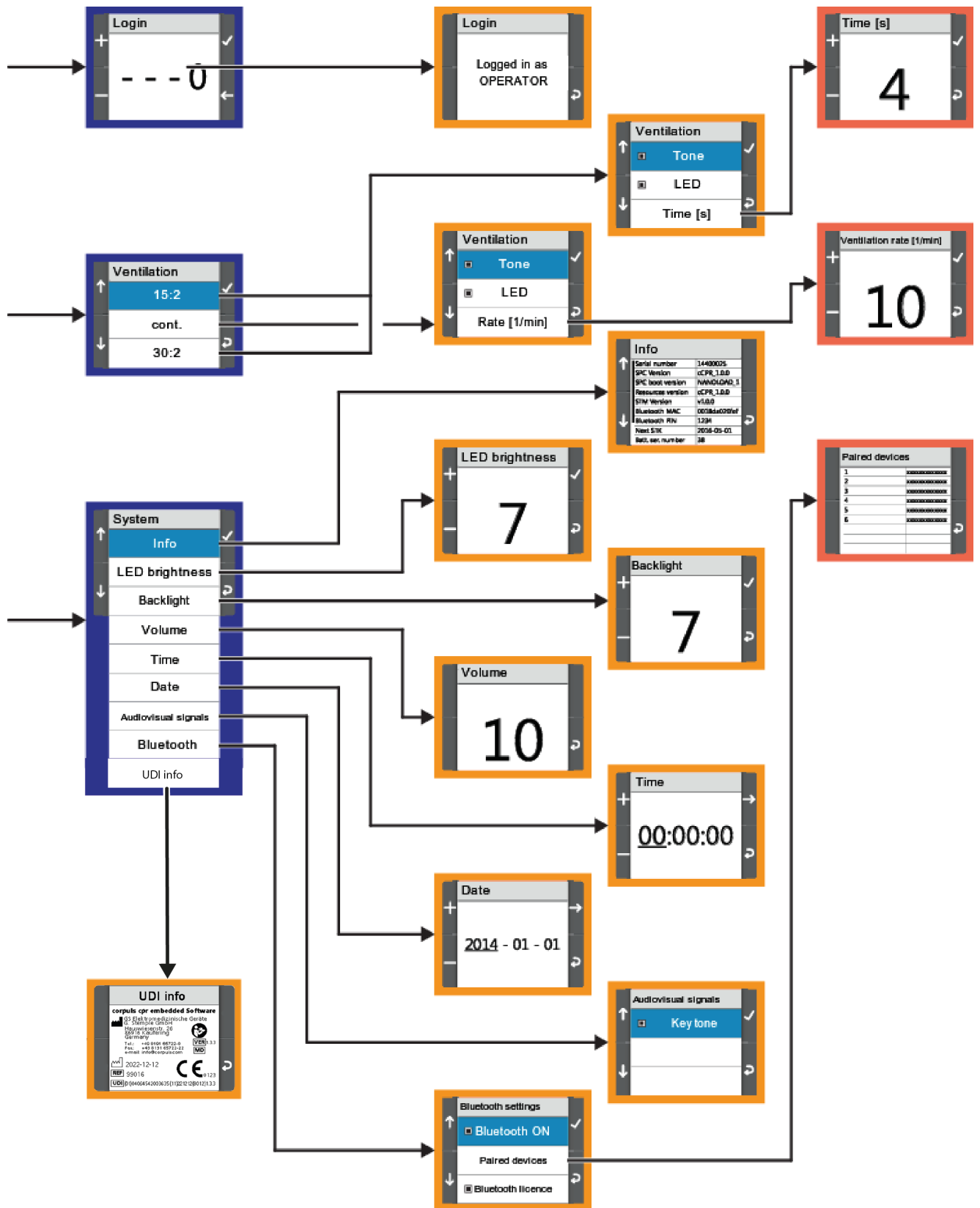

VII Overview of Menu Navigation OPERATOR

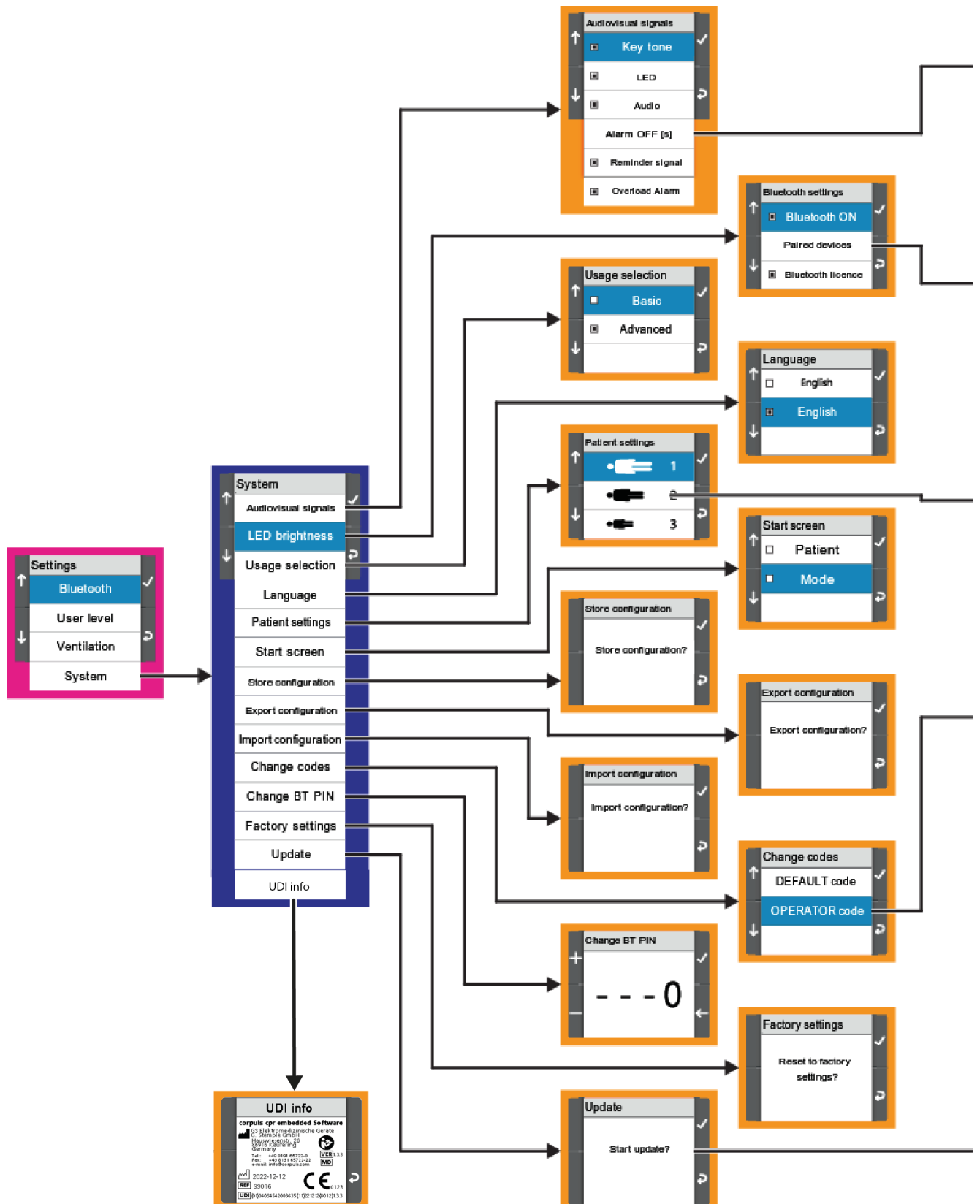

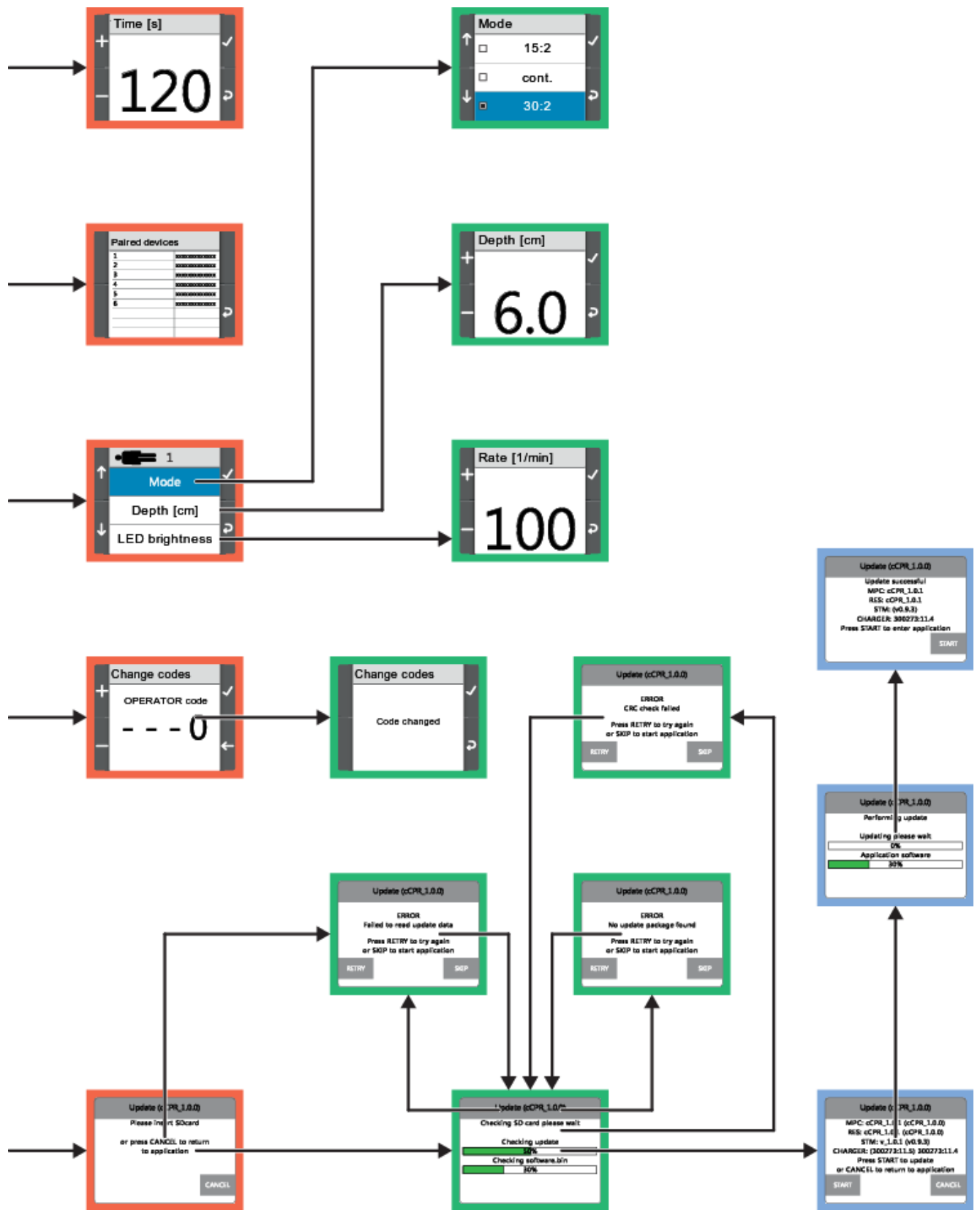

VIII Guidelines and Manufacturer's Declaration

Electromagnetic emission		
The corpuls cpr is intended for operation in the electromagnetic environment indicated below. The operator or the user must ensure that the corpuls cpr is operated in such an environment.		
Emission measurements	Compliance	Electromagnetic environment - guidelines
HF emissions in accordance with CISPR 11	Group 1	<p>The corpuls cpr uses HF energy only for its internal function. The HF emission is very low. Therefore the risk of the corpuls cpr impairing the function of adjacent electronic devices is unlikely.</p> <p>According to IEC 60601-1-2, the corpuls cpr is intended for use in the EM environments "areas of home health care" and "professional healthcare institutions".</p> <p>These are among others:</p> <ul style="list-style-type: none"> • EMS and patient transport vehicles • Pre-hospital and intra-hospital emergency care environments (inside and outside of closed rooms)
HF emissions in accordance with CISPR 25	ECE R-10	
HF emissions in accordance with CISPR 11	Class B	
Emission of harmonic oscillations in accordance with IEC 61000-3-2	Only to be used with a class A AC adapter	
Voltage fluctuations/flicker in accordance with IEC 61000-3-3	Only to be used with an AC adapter	

Tab. 8-14 Electromagnetic emission

Electromagnetic interference immunity			
The corpuls cpr is intended for operation in the electromagnetic environment indicated below. The operator or the user must ensure that the corpuls cpr is operated in such an environment.			
Interference immunity tests	IEC 60601 test level	Compliance level	Electromagnetic environment-guidelines
Electrostatic discharge (ESD) in accordance with IEC 61000-4-2	±8 kV contact discharge ±15 kV aerial discharge	±8 kV contact discharge ±15 kV aerial discharge	Floors should be made of wood, concrete or metal or be covered with ceramic tiles. If the floor is covered with synthetic material, the relative humidity should be at least 30 %.
Rapid transient electrical interference/bursts in accordance with IEC 61000-4-4	±2 kV for mains leads	±2 kV for mains leads	The quality of the power supply should correspond to that of a typical business or hospital environment.
Surges according to IEC 61000-4-5	±1 kV line to line ±2 kV line to ground	±1 kV line to line ±2 kV line to ground	The quality of the power supply should correspond to that of a typical business or hospital environment.
Voltage dips, brief interruptions and fluctuations in the power supply in accordance with IEC 61000-4-11	2 cm 0 % U_T for 0.5/1 period 70 % U_T for 25/30 periods 0 % U_T for 250/300 periods	Only to be used with tabletop AC adapter	The corpuls cpr is always operated with a battery buffer. The user must make sure that the battery in the device is always adequately charged.
Magnetic field of the supply frequency (50/60 Hz) in accordance with IEC 61000-4-8	30 A/m50 Hz	30 A/m50 Hz	Do not operate the corpuls cpr near an activated MRI unit (magnetic resonance imaging).
Note: U_T is the mains alternating voltage before application of the test level.			

Tab. 8-15 Electromagnetic interference immunity part 1

Electromagnetic interference immunity			
The corpuls cpr is intended for operation in the electromagnetic environment indicated below. The operator or the user must ensure that the corpuls cpr is operated in such an environment.			
Interference immunity tests	IEC 60601 test level	Compliance level	Electromagnetic environment - guidelines
n/a	n/a	n/a	Portable/mobile radio devices should not be used at a distance less than the recommended protection distance to the corpuls cpr including the leads. A protection distance of at least 0.3 m is recommended.
Conducted HF interference in accordance with IEC 61000-4-6	$3 V_{\text{eff}}$ 150 kHz to 80 MHz outside the ISM bands ^a $6 V_{\text{eff}}$ 150 kHz to 80 MHz within the ISM bands ^a	$3 V_{\text{eff}}$	$d = 1.2\sqrt{P}$

Tab. 8-16 Electromagnetic interference immunity part 2

Electromagnetic interference immunity			
Radiated HF interference in accordance with IEC 61000-4-3	10 V/m 80 MHz to 2.7 GHz	10 V/m 80 MHz to 2.7 GHz	<p>$d = 0.6\sqrt{P}$</p> <p>P being the maximum nominal output of the transmitter in watts (W) in accordance with the transmitter manufacturer's specifications and d being the recommended protection distance in metres (m).^b</p> <p>The field strength of stationary radio transmitters should be lower than the ambient level ^c for all frequencies according to an on-site test.^d</p> <p>Interference is possible in the vicinity of devices that bear the following pictorial symbol:</p>
	27 V/m	27 V/m	380 MHz - 390 MHz TETRA 400
	28 V/m	28 V/m	380 MHz - 390 MHz TETRA 400
	9 V/m	9 V/m	704 MHz - 787 MHz LTE Band 13, 17
	28 V/m	28 V/m	800 MHz - 960 MHz GSM 800/900 TETRA 800 iDEN 820 CDMA 850 LTE Band 5
	28 V/m	28 V/m	1700 MHz - 1990 MHz GSM 1800 CDMA 1900 GSM 1900 DECT LTE Band 1/3/4/25 UMTS
	28 V/m	28 V/m	2400 MHz - 2570 MHz Bluetooth WLAN 802.11 b/g/n RIFD 2450 LTE Band 7
	28 V/m	9 V/m	5100 MHz - 5800 MHz WLAN 802.11 a/n
<p>Comment 1</p> <p>At 80 MHz and 800 MHz the higher frequency range applies.</p> <p>Comment 2</p> <p>These guidelines may not be applicable in all cases. Propagation of electromagnetic variables is influenced by absorption and reflection via buildings, objects and people.</p>			

Electromagnetic interference immunity

<p>^a The ISM frequency bands (for industrial, scientific and medical applications between 150 kHz and 80 MHz) are 6.765 MHz to 6.795 MHz; 13.553 MHz to 13.567 MHz; 26.957 MHz to 27.283 MHz and 40.66 MHz to 40.70 MHz.</p>

<p>^b The compliance levels in the ISM frequency bands between 150 kHz and 80 MHz and in the frequency range of 80 MHz and 2.5 GHz are intended to reduce the likelihood that portable/mobile communication devices will be able to cause interference if they are unintentionally brought into the patient area. For this reason, the additional factor 10/3 is applied in calculating the recommended protection distances in these frequency ranges.</p>

<p>^c It is theoretically not possible to precisely determine in advance the field strength of stationary transmitters such as e.g. base stations of mobile telephones and mobile terrestrial radio devices, amateur radio stations, and AM and FM radio and television transmitters. To establish the electromagnetic environment with regard to stationary transmitters, a study of the location should be considered. If the measured field strength at the location at which the device is used exceeds the above mentioned compliance level, the device must be observed to verify function as intended. If unusual performance characteristics are observed, additional measures may be required, such as e.g. a modified orientation or another location for the device.</p>

<p>^d Above the frequency range of 150 kHz to 80 MHz the field strength must be less than 3 V/m.</p>
--

Tab. 8-17 Electromagnetic interference immunity part 3



There is no limitation for the operation of the corpuls cpr in an electrically active environment. For operation in an extreme electrically active environment, consultation of the manufacturer is recommended.



Within the framework of intended use, the corpuls cpr, with the exception of the external battery charger, can be operated together with HF surgical devices pursuant to IEC 60601-2-2 Annex BB.4.

Recommended protection distances between portable/mobile HF communication devices and the device				
The corpuls cpris intended for operation in an electromagnetic environment in which radiated HF interference is controlled. The operator or the user of the corpuls cprcan help to prevent electromagnetic interference by observing minimum distances between portable/mobile HF communication devices (transmitters) and the corpuls cpras recommended below in accordance with the maximum output of the communication device.				
Nominal output of the transmitter in W	Protection distance in accordance with transmission frequency in m			
	150 kHz to 80 MHz outside the ISM bands $d = 1.2\sqrt{P}$	150 kHz to 80 MHz in the ISM bands $d = 4.0\sqrt{P}$	When used as a monitor When used as a monitor	
			80 MHz to 800 MHz $d = 4.0\sqrt{P}$	800 MHz to 2.5 GHz $d = 7.7\sqrt{P}$
0.01	0.12	0.40	0.40	0.77
0.1	0.38	1.3	1.3	2.4
1	1.2	4.0	4.0	7.7
10	3.8	13	13	24
100	12	40	40	77
For transmitters, whose nominal output is not indicated in the table above, the distance can be determined using the equation which corresponds to the respective column. P is the nominal output of the transmitter in watts (W) in accordance with the transmitter manufacturer's specification.				
Comment 1 The ISM bands between 150 kHz and 80 MHz are 6.765 MHz to 6.795 MHz; 13.553 MHz to 13.567 MHz; 26.957 MHz to 27.283 MHz and 40.66 MHz to 40.70 MHz.				
Comment 2 To calculate the recommended protection distance of transmitters in the ISM frequency bands between 150 kHz and 80 MHz and in the frequency range between 80 MHz to 2.5 GHz an additional factor of 10/3 is used to reduce the likelihood that a portable/mobile communications device brought into the patient area will result in interference.				
Comment 3 These guidelines may not apply in all situations. Propagation of electromagnetic waves is influenced by absorption and reflection via buildings, objects and people. Subject to technical modifications.				

Tab. 8-18 Recommended protection distances

 **WARNING!**

Electromagnetic interferences due to too little protection distance!

Could result to degradation of the performance of this equipment.

- ▶ Do not use Portable RF communications equipment (including peripherals such as antenna cables and external antennas) closer than 30 cm (12 inches) to any part of the corpuls cpr including cables specified by the manufacturer.

**WARNING!**

Increased electromagnetic emissions or decreased electromagnetic immunity of this equipment due to use of accessories, transducers and cables other than those specified or provided by the manufacturer of this equipment!

Can lead to improper operation.

- ▶ Exclusively use accessories, transducers and cables specified or provided by the manufacturer of this equipment.
-

IX List of Abbreviations

Measuring units:

1/min	Rate
A	Ampere
Ah	Ampere hour
dB	Decibel
s	Second
h	Hour
V	Volt
W	Watt

Abbreviations:

ECG	Electrocardiogramme
CPR	Cardio-pulmonary resuscitation
incl.	including
LED	Light-emitting diode
MPBetreibV	Medical Devices Operator Ordinance
n/a	not available
RoPD [®]	Rosenberger power data connector
SD™ card	Secure digital memory card
UDI	Unique Device Identification

X Residual Risks

The user must read the user manual before using the corpuls cpr and follow the indications, warnings and cautions. Otherwise the following hazardous situations may arise:

No.	Risk situation	Risk group		
		Patient	User	Third party
1	Risk due to publicly available device data (cyber security)	x		
2	Risk due to inadequate ventilation of the lungs	x		
3	Damage to rescue vehicles, rescue materials or rescue stations	x	x	x
4	Inadequate therapy due to wrong positioning in thorax compressions	x		
5	Inadequate therapy due to wrong compression rate	x		
6	Inadequate therapy due to wrong compression depth	x		
7	Slightly delayed therapy (less than 20 s)	x		
8	Delayed therapy (more than 20 s)	x		
9	No therapy / therapy failure without manual therapy	x		
10	Irritation of the patient's skin due to the stamp material	x		
11	Patient falling from the transport device during transfer	x	x	x
12	Injury / burn injury due to touching hot parts	x	x	x
13	Risk due to electrical discharge (max. 32 V)	x	x	x
14	Cross contamination due to biological agents	x	x	x
15	Adverse effects of therapy	x		
16	Risk due to impact of mechanical energy on users and third parties		x	x
17	Risk due to impact of mechanical energy on patient	x		
18	Risk due to therapy during rhythm assessment and defibrillation (unintended)	x	x	x
19	Risk due to unintended therapy (Therapy without indication)	x	x	x

XI RED Declaration of Conformity

Hereby, GS Elektromedizinische Geräte G. Stemple GmbH declares that the corpuls cpr is in compliance with Directive 2014/53/EU. The full text of the EU declaration of conformity is available at the following internet address:

[corpuls cpr: Certificates / Test Results](#)

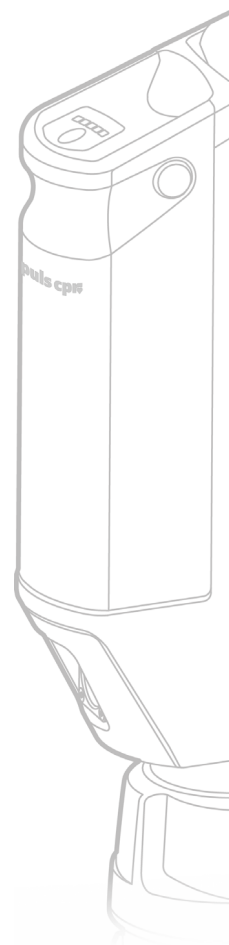

GS Elektromedizinische Geräte GmbH
Hauswiesenstraße 26 | 86916 Kaufering

Telefon + 49 8191 65722-0
Fax + 49 8191 65722-22
E-mail info@corpuls.com
Web www.corpuls.world



P/N 09130.02 | Version 1.3 C

