



**User Manual**

---

(Page intentionally left blank)

 GS Elektromedizinische Geräte

G. Stemple GmbH

Hauswiesenstraße 26

86916 Kaufering

Germany



For a patient/user/third party in the European Union and in countries with identical regulatory regime (Regulation 2017/745/EU on Medical Devices); if, during the use of this device or as a result of its use, a serious incident has occurred, please report it to the manufacturer and/or its authorised representative and to your national authority.

Subject to technical modifications, mistakes and printing errors.

The rights to the trademarks and registered trademarks named remain with the originators and the holders of the respective trademark rights.

The use of this User Manual for the following purposes is not permitted without the written consent of GS Elektromedizinische Geräte G. Stemple GmbH: Reproduction, storage, processing, duplication, translation and distribution.

Further technical information can be obtained from the manufacturer.

## Versions of the User Manual

Issue	Date	Version of User manual	Version corpuls1
1	2013-04-24	1.0	1.0
2	2013-12-17	1.1	1.1.0
3	2015-04-20	1.2	1.2.0
4	2015-11-16	1.3	1.3.2
5	2016-09-23	1.3	1.3.3
6	2018-04-12	2.0	2.0.0
7	2018-09-26	2.0.1	2.0.0
8	2018-11-27	2.0.2	2.0.0
9	2020-02-07	2.1	2.1.0
10	2020-08-18	2.1.1	2.1.0

## New in this Version

The following table gives an overview of all new features in this version:

Description
Issues relevant for MDR.
Updated disinfectant list.
Updated description of therapy with shock paddles and baby shock electrodes.

## Service Address

For questions, please contact authorised sales and service partners:

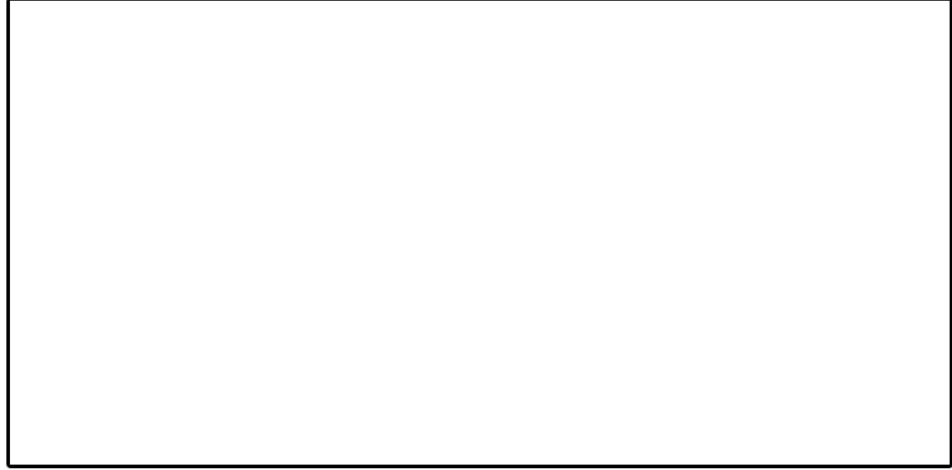

Information on authorised sales and service partners can be found at:

*[www.corpuls.world](http://www.corpuls.world)*

## Table of Contents

1	Evaluation Software.....	1
2	Performance Description .....	3
2.1	Intended Use .....	3
2.2	Appropriate Use.....	3
2.3	Indications and Contraindications.....	4
2.4	Patient group.....	5
3	Directions for Users.....	7
3.1	Requirements for the User.....	7
3.2	Use of the Manual.....	7
3.2.1	Typographic Conventions.....	7
3.2.2	Content-related Conventions.....	8
3.2.3	Depiction of Warnings.....	8
3.2.4	Depiction of Notes .....	8
3.3	Related Documents.....	9
3.4	Data Protection.....	9
3.5	Symbols.....	9
4	Safety.....	12
4.1	Safety instructions for the user .....	12
4.2	Warning- and Notice Labels on the Device.....	14
5	Device Description .....	16
5.1	Description of Functions .....	16
5.1.1	Monitoring Functions .....	16
5.1.2	Therapeutic Functions.....	16
5.2	Connections.....	17
5.2.1	Front Side of the Device.....	17
5.2.2	Rear Side of the Device.....	18
5.2.3	Right Hand Side of the Device.....	19
5.2.4	Bottom Side of the Device.....	20
5.3	Display and Operation Elements.....	21
5.4	Battery Operation.....	22
5.5	Mains Operation.....	23
5.6	Alarm Design .....	23
5.6.1	Warnings .....	23
5.6.2	Alarming in the Status Line .....	24

5.6.3	Alarming in the Vital Parameter Field.....	25
6	Commissioning .....	26
6.1	Unpacking the Device .....	26
6.2	Switching the Device on and off.....	26
6.2.1	Switching on the Device.....	26
6.2.2	Switching the Device off .....	27
6.2.3	Automatic Shutdown.....	28
6.3	Charging the Battery.....	29
6.4	Replacing the Battery .....	30
6.5	Inserting the SD Card.....	31
6.6	Removing the SD Card.....	32
7	User Interface in Monitoring Mode.....	33
7.1	Structure of the User Interface.....	33
7.2	Main Menu.....	35
7.2.1	Opening the Main Menu .....	35
7.2.2	Overview Main Menu.....	36
7.2.3	Navigating in the Menu .....	36
7.3	Overview Parameter- and Curve Context Menu.....	37
7.4	Vital Parameter Context Menu.....	38
7.4.1	Open Vital Parameter Context Menu .....	38
7.4.2	Overview Vital Parameter Context Menu.....	39
7.4.3	Changing Vital Parameter Settings.....	39
7.4.4	Switching off a Vital Parameter Alarm .....	40
7.4.5	Switching on a Vital Parameter Alarm.....	40
7.4.6	Adopting Auto Limits.....	41
7.5	Curve Context Menu .....	41
7.5.1	Open Curve Context Menu .....	41
7.5.2	Overview Curve Context Menu .....	42
7.5.3	Changing Curve Parameters .....	42
7.5.4	Changing the Sweep Speed.....	43
7.5.5	Changing the Curve Amplitude .....	43
7.6	Softkey Context Menu .....	43
7.6.1	Softkey Context Menu QRS/PT.....	44
7.6.2	Softkey Context Menu View .....	44
7.7	Screenshot Function .....	45
7.7.1	Creating a Screenshot.....	45
7.7.2	Showing Screenshots.....	46
7.8	Alarm Suspension.....	47
7.8.1	Activating Alarm Suspension.....	47
7.8.2	Deactivating Alarm Suspension.....	47
7.9	Alarm Tone Silencing Function.....	48



7.9.1	Enabling the Alarm Tone Silencing Function.....	48
7.10	Alarm History.....	48
7.10.1	Opening Alarm History.....	48
7.10.2	Displaying Alarm History.....	49
7.10.3	Confirm Alarms.....	50
8	User Interface in Defibrillation Mode.....	51
8.1	Structure of the User Interface.....	51
8.2	Shock Energy.....	52
8.3	Softkey Context Menu.....	53
8.3.1	Softkey Context Menu Metronome.....	53
8.3.2	Softkey Context Menu Synchronisation Option.....	53
8.3.3	Softkey Context Menu Shock Energy.....	54
8.4	Charging the Defibrillator.....	54
8.5	corPatch CPR for assistance with thorax compressions (option).....	55
8.6	Switching to Monitoring Mode.....	56
9	User Interface in Pacer Mode (Option).....	57
9.1	Structure of the User Interface.....	57
9.2	Main Menu.....	58
9.3	Intensity.....	58
9.4	Pacer Mode.....	58
9.5	Frequency.....	59
9.6	Application Note Pacer.....	59
9.7	Switching to Monitoring Mode.....	60
10	Operation - Monitoring.....	61
10.1	Warnings.....	61
10.2	Patient group.....	61
10.3	ECG Monitoring.....	62
10.3.1	Colour Coding ECG Monitoring Cable.....	62
10.3.2	Starting ECG Monitoring.....	62
10.4	Pulse Oximetry Monitoring (Option).....	63
10.4.1	Warnings.....	63
10.4.2	Pulse Oximetry Measuring Options.....	65
10.4.3	Starting Pulse Oximetry Monitoring.....	66
10.5	Connecting Cables and Sensors to the Device.....	67
10.5.1	ECG Monitoring Cable (Accessories).....	67
10.5.2	Pulse Oximetry Sensor (Accessories).....	67
10.6	Preparing the Patient.....	69
10.7	Attaching Electrodes and Sensors to the Patient.....	69
10.7.1	ECG Monitoring Cable (Accessories).....	69
10.7.2	Pulse Oximetry Sensor (Accessories).....	71

11	Operation – Therapy .....	72
11.1	Warnings .....	72
11.2	Patient group .....	74
11.3	Overview Therapy Electrodes .....	74
11.4	Defibrillation and Cardioversion .....	75
11.4.1	Warnings .....	76
11.4.2	Patient Impedance .....	77
11.4.3	Calling up AED Mode .....	78
11.4.4	Overview AED Mode .....	79
11.4.5	Performing Defibrillation in AED Mode with corPatch easy Electrodes.....	81
11.4.6	Calling up the Manual Mode.....	82
11.4.7	Overview Manual Mode .....	83
11.4.8	Performing Defibrillation and Cardioversion in Manual Mode with corPatch easy Electrodes .....	85
11.4.9	Performing Defibrillation and Cardioversion in Manual Mode with Shock Paddles.....	86
11.4.10	Performing Defibrillation and Cardioversion on Children and Neonates in Manual Mode with Baby Shock Electrodes.....	87
11.4.11	Performing Defibrillation and Cardioversion in Manual Mode with Shock Spoons .....	89
11.5	Pacer (Option).....	90
11.5.1	Warnings .....	91
11.5.2	Calling up the Pacer Mode .....	91
11.5.3	Overview Pacer mode.....	92
11.5.4	Performing Pacer Therapy.....	93
11.5.5	Pausing the Pacer Mode.....	95
11.5.6	Exiting the Pacer Mode .....	96
11.6	Metronome for Assistance with Thorax Compressions.....	96
11.6.1	Overview Metronome Settings.....	97
11.6.2	Starting the Metronome .....	97
11.7	corPatch CPR for assistance with thorax compressions (option) .....	98
11.7.1	Warnings .....	100
11.7.2	Supporting CPR with the corPatch CPR Disposable Sensor .....	100
11.8	Connecting Therapy Electrodes to the Device.....	101
11.8.1	corPatch easy Electrodes or Shock Paddles (Accessories).....	101
11.8.2	corPatch CPR Disposable Sensor (Accessories).....	103
11.8.3	Shock Spoons (Accessories) .....	104
11.9	Preparing the Patient.....	105
11.10	Attaching therapy electrodes to the patient.....	105
11.10.1	corPatch easy Electrodes for Defibrillation and Cardioversion (Accessories).....	105
11.10.2	corPatch easy Electrodes for Pacer Therapy (Accessories) .....	106

11.10.3	Shock Paddles for Defibrillation and Cardioversion (Accessories).....	107
11.10.4	corPatch CPR Disposable Sensor (Accessories).....	108
11.11	End Therapy Mission.....	109
12	Mission Data Management.....	110
12.1	Mission Data Storage.....	110
12.1.1	Warnings.....	110
12.2	SD Card (Accessories).....	111
13	Settings Main Menu.....	112
13.1	Overview Settings.....	112
13.2	Changing Settings.....	113
13.3	Menu item Alarms.....	113
13.3.1	Warnings.....	113
13.3.2	Submenu item Limits.....	114
13.3.3	Submenu item Auto limits.....	116
13.3.4	Submenu item Settings.....	117
13.4	Menu item Signals.....	118
13.4.1	Submenu item Curves.....	118
13.4.2	Submenu item Parameters.....	120
13.4.3	Submenu item Views.....	122
13.5	Menu item ECG.....	123
13.5.1	Submenu item Settings.....	123
13.6	Menu item Defib.....	124
13.6.1	Submenu item Metronome.....	124
13.6.2	Submenu item CPR.....	125
13.7	Menu item Oximetry.....	126
13.7.1	Submenu item Settings.....	126
13.7.2	Submenu item Info.....	129
13.8	Menu item Patient.....	129
13.8.1	Submenu item Screenshots.....	129
13.8.2	Submenu item Patient class/-group.....	130
13.8.3	Submenu item Enter Data.....	130
13.9	Menu Item System.....	132
13.9.1	Submenu item Mission.....	132
13.9.2	Submenu item Settings.....	133
13.9.3	Submenu item Info.....	136
13.9.4	Submenu item Login.....	137
14	Settings Main menu (User level OPERATOR).....	138
14.1	Menu item Alarms.....	138
14.1.1	Warnings.....	138
14.1.2	Submenu item Settings.....	138

14.2	Menu item ECG.....	140
14.2.1	Submenu item Filter .....	140
14.3	Menu item Defib.....	141
14.3.1	Submenu item Metronome .....	141
14.3.2	Submenu item Settings.....	143
14.3.3	Submenu item AED.....	144
14.3.4	Submenu item Manual .....	146
14.3.5	Submenu item CPR.....	148
14.4	Menu item Pacer (Option) .....	149
14.5	Menu item Telemetry .....	151
14.5.1	Submenu item LAN .....	151
14.6	Menu Item System .....	153
14.6.1	Submenu item Settings.....	153
14.6.2	Submenu item Update.....	156
14.6.3	Submenu item Service .....	160
14.6.4	Submenu item Login .....	162
14.6.5	Submenu item Mission.....	163
15	Functional Test and Maintenance.....	165
15.1	Warnings .....	165
15.2	Test- and Maintenance Intervals.....	166
15.3	Functional Test .....	166
15.4	Selftest.....	171
15.4.1	Self Test Switch on .....	171
15.4.2	Automatic Self-test .....	171
15.5	Regular Maintenance Work .....	172
15.5.1	Technical Safety Check.....	172
15.5.2	Repair and Service.....	172
15.6	Cleaning and Disinfection .....	172
15.6.1	Recommended Cleaning- and Disinfecting Agents.....	173
15.6.2	Warnings .....	173
15.6.3	Cleaning and Disinfecting the Device .....	174
15.6.4	Cleaning and Disinfecting the Charging Bracket (Accessories).....	175
15.6.5	Cleaning and Disinfecting the Pulse Oximetry Sensor (Accessories) .....	175
15.6.6	Cleaning and Disinfecting the ECG Monitoring Cable (Accessories) .....	175
15.6.7	Cleaning and Disinfecting the Accessory Bags and Front Cover (Accessories).....	176
15.6.8	Cleaning and Disinfecting Shock Paddles (Accessories).....	176
15.6.9	Cleaning and Disinfecting Baby Shock Electrodes (Accessories) .....	176
15.6.10	Cleaning and Disinfecting the Therapy Master Cable (Accessories).....	177
15.6.11	Cleaning and Disinfecting the corPatch CPR Intermediate Cable (Accessories) .....	177

16	Service Events .....	178
17	Alarms and Messages.....	180
17.1	Warnings .....	180
17.2	Alarm List.....	181
17.3	List of Messages.....	191
18	Charging brackets (Accessories).....	201
18.1	Warnings .....	201
18.2	Replace Fuse .....	201
18.3	Fixating the Charging Bracket .....	202
18.4	Using the Charging Bracket.....	202
18.4.1	Inserting the Device into the Charging Bracket .....	202
18.4.2	Removing from the Charging Bracket.....	203
18.5	Using the Adapter Charging Bracket.....	203
18.5.1	Inserting the Device into the Adapter Charging Bracket .....	203
18.5.2	Remove the Device from the Adapter Charging Bracket.....	204
19	Accessory Bags, Fold-out Supports and Front Cover (Accessories).....	205
19.1	Warnings .....	205
19.2	Packing and Fixating the left Accessory Bag.....	206
19.3	Packing and Fixating the right Accessory Bag.....	207
19.4	Pack the Front Cover.....	208
19.5	Attaching Shock Paddles to Shock Paddle Holders on the Accessory Bags. ....	209
Appendix	.....	211
A	List of Abbreviations.....	211
B	Measuring Units and Operators.....	213
C	Glossary .....	215
D	Warranty.....	216
E	Protection Rights and Patents.....	217
F	Approved Accessories, Spare Parts and Consumables .....	218
G	Disposal.....	219
H	Technical Specifications .....	220
I	Major Performance Characteristics .....	239
J	Guidelines and Manufacturer's Declaration.....	240
K	Reset to Factory Settings.....	246
L	Checklist Functional test .....	251
M	Masimo Safety Information.....	252
N	List of Tables .....	255
O	List of Illustrations .....	259
Index	.....	263

(Page intentionally left blank)

# 1 Evaluation Software

---

The software for evaluation of mission data is available free of charge with every device. The software can be downloaded at *my.corpuls.world*.

## Compatibility with other corpuls products

The following table gives an overview of the compatibility to corpuls1.

version	Compatible corpuls1 version
1.0	-
1.1	-
1.2	1.0.0
1.3	1.0.0 1.1.0
1.4	1.0.0 1.1.0
1.5	1.0.0 1.1.0 1.2.0
1.6	1.0.0 1.1.0 1.2.0 1.3.x
Darwin 1906 (2.1)	1.0.0 1.1.0 1.2.0 1.3.x 2.0.x 2.1.x
Everest 1908 Everest 1912	1.0.0 1.1.0 1.2.0 1.3.x 2.0.x 2.1.x

version	Compatible corpuls1 version
Franklin 2005	1.0.0 1.1.0 1.2.0 1.3.x 2.0.x 2.1.x



## 2 Performance Description

---

### 2.1 Intended Use

The corpuls1 is a defibrillator/patient monitoring system/external pacer and is intended for the following purposes for the treatment of emergency- and intensive-care patients:

- Monitoring patients.
- Measuring vital parameters.
- Performing defibrillations and cardioversions on adults, children and neonates.
- Performing external pacer therapy (option).
- Check the quality of thorax compressions in cardiopulmonary resuscitation (optional).

The following therapy functions are available:

- Defibrillation (AED mode, manual mode)
- Cardioversion
- External pacer therapy (option)

The following monitoring functions are available in monitoring mode:

- ECG

Optional:

- Pulse oximetry (PP, PI, SpO<sub>2</sub>)
- Extended Oximetry (SpCO<sup>®</sup>, SpHb<sup>®</sup>, SpMet<sup>®</sup>)

### 2.2 Appropriate Use

The corpuls1 is intended for use in emergency services on location, in an ambulance, in the emergency room or similar areas of a hospital. It is also intended to be used during transport of a patient.

According to IEC 60601-1-2, the corpuls1 is intended for use in areas of home health care and in professional healthcare institutions.

The corpuls1 is approved for monitoring in operating diagnostic X-ray units (e. g. computed tomography). Exempt from this is the oximetry option, because the readings might be falsified.

If among others the following points are applicable, the user is in compliance with the intended use of the corpuls1:

- The user observes the instructions in the User Manual.
- The battery is inserted in the corpuls1.
- The user uses the corpuls1 according to its purpose (refer to 2.1 Intended Use on page 3).
- The user operates the corpuls1 in monitoring mode with the monitoring functions.
- The user performs defibrillations and cardioversions with the corpuls1 in the defibrillation modes.
- The user operates the corpuls1 with the corPatch CPR function as a feedback instrument

during cardiopulmonary resuscitation.

- The user operates the corpuls1 in pacer mode for external electrical stimulation of the heart muscle.
- The user operates the corpuls1 on only one patient at a time and not on several patients.
- Defibrillation, cardioversion and stimulation are performed with eye contact to the patient.
- The user does not operate the corpuls1 in the defibrillation modes as pacer or stimulation current device.
- The user does not operate the corpuls1 as intracardial pacer.
- The user does not operate the corpuls1 under the influence of strong electromagnetic fields. Example: In the direct vicinity of radio masts, activated magnetic resonance tomography units, high voltage installations and overhead power lines.
- The user does not operate the corpuls1 in the vicinity of readily flammable anaesthetics or other flammable substances.
- The user does not operate the corpuls1 in an oxygen-rich (> 23%) environment.
- The user does not operate the corpuls1 in connection with a high-frequency surgical device.
- The user complies with the operating requirements for operation of the corpuls1 (refer to 3.1 Requirements for the User on page 7).
- The user uses approved accessories, spare parts and consumables (refer to F Approved Accessories, Spare Parts and Consumables on page 218).
- There are no technical faults and critical alarms.

## 2.3 Indications and Contraindications

### Defibrillation and Cardioversion

Indications and contra-indications of defibrillation are described in AED mode and of defibrillation and cardioversion in manual mode in the following. According to the age of the patients, appropriate corPatch easy therapy electrodes must be used.

Indications:

- Defibrillation of adults, children and neonates for tachycardic arrhythmias (e. g. ventricular fibrillation) and resulting circulatory arrest.
- Cardioversion of cardiac arrhythmias.

Contra-indications:

- Defibrillation/cardioversion with normal ECG rhythm.
- Defibrillation/cardioversion with pulseless electrical activity (PEA).
- Defibrillation/cardioversion with asystole.
- Defibrillation with a palpable pulse or other indications of spontaneous circulation.
- Defibrillation of patients younger than 12 months in AED mode is not recommended. For this, the manual mode is intended.

### Pacing

Indications and contra-indications for pacing in FIX/DEMAND mode are described in the following. According to the age of the patients, appropriate corPatch easy therapy electrodes must be used.

Indications:

- Transcutaneous stimulation is used in adults and children with bradycardic arrhythmias.
- Transcutaneous stimulation can be used as stand-by measure, if there is a risk of cardiac

arrest or bradycardia e. g. due to a myocardial infarction.

Contraindications:

- Pacing in case of ventricular fibrillation.
- Pacing in FIX mode when DEMAND mode is indicated.

#### corPatch CPR

Indications and contraindications of the corPatch CPR feedback function are described in the following.

Indications:

- Control of the quality of the cardiac massage, as part of a resuscitation.

Contraindications:

- If chest compression is not indicated.



Chest compression for patients under 8 years with the corPatch CPR feedback function is not recommended.

#### ECG Monitoring

Indications and contra-indications for ECG monitoring are described in the following.

Indications:

- Monitoring and recording of ECG and heart rate of adults, children and neonates with or without cardiac dysfunctions.

Contra-indications:

- none

#### Pulse oximetry monitoring

Indications and contra-indications for non-invasive pulse oximetry monitoring are described in the following.

Indications:

- Pulse oximetry monitoring allows continuous non-invasive monitoring of peripheral pulse rate (PP), perfusion index (PI), and arterial oxygen saturation (SpO<sub>2</sub>). Die Alarmhistorie zeigt alle aktiven unbestätigten und bestätigten und nicht automatisch verschwunden Alarme an. Extended oximetry options (available only with Masimo Rainbow SET® Technology) include measurement of the methemoglobin level (SpMet®) and, depending on the used oximetry sensor, the level of carboxyhemoglobin (SpCO®) in percentage or the level of total hemoglobin (SpHb) in g/dl or mmol/l. The oximetry option and the pertaining accessories are appropriate for use on adults, children and neonates.

Contra-indications:

- none

## 2.4 Patient group

With the selection of available monitoring sensors/electrodes it is possible to treat adults, children as well as neonates (refer to 10.2 Patient group on page 61). For this, different sizes are available.

With the selection of available therapy electrodes it is possible to treat adults, children as well as neonates (refer to 11.2 Patient group on page 74). When using shock spoons, the dimensions of the patient's heart determine the size to be used. For this, three different sizes/types are available.



Therapy electrodes of the type shock spoon should only be used for therapy on children and adults.

---



All available types of monitoring sensors/electrodes and therapy electrodes can be found in the overview of approved accessories and consumables (refer to F Approved Accessories, Spare Parts and Consumables on page 218).

---

## 3 Directions for Users

---

### 3.1 Requirements for the User

In order to operate the corpuls1, among others, the following requirements have to be met by users:

- Users must be specialist medical personnel.
- Users must be trained in basic and advanced resuscitation measures.
- Users have been trained in handling the corpuls1. Applicable national laws and guidelines must be observed during training on the device.

### 3.2 Use of the Manual

The user manual has been compiled to enable better understanding of the corpuls1.

The user manual provides users with the following information:

- Safe and trouble-free operation of the corpuls1.
- Using the corpuls1 on a patient.
- Maintenance of the corpuls1.
- Troubleshooting help.

In addition to this user manual, the currently applicable laws, statutory- and hygiene regulations, generally accepted rules of technology as well as regulations for occupational health and safety and accident prevention must be complied with.

#### 3.2.1 Typographic Conventions

The following table describes the typographic conventions.

Typographic conventions	Description
<b>Key</b>	Indicates a key.
[Softkey]	Indicates a softkey.
"Menu item"	Indicates a menu item.
▶ "Submenu item"	Indicates a submenu item.
"Alarm"	Indicates an alarm.
<b>Message</b>	Indicates a message.
<i>List</i>	Indicates a list.
<i>List box</i>	Indicates a list box.
<i>Value</i>	Indicates the value of a list box.

Table 3-1 Typographic Conventions

### 3.2.2 Content-related Conventions

- (option)** Device options are marked with “(Option)” in the headlines. If the corpuls1 is equipped with the respective option, the user must heed the information regarding this option.
- (Accessories)** Accessories are marked with “(Accessories)” in the headlines. If the corpuls1 is equipped with accessories, the user must heed the information regarding the accessories.
- User** The user is the operator of the corpuls1.  
Depending on the user level DEFAULT, MAN. DEFIB. and OPERATOR, the user is called “User DEFAULT”, “User MAN. DEFIB.” and “User OPERATOR”.

### 3.2.3 Depiction of Warnings

Warnings alert the user of possible sources of danger. Warnings are categorised into four levels of danger. The levels of danger DANGER, WARNING and CAUTION denote bodily injuries. The danger level NOTICE indicates material- and environmental damage. Warnings for a chapter are listed at the beginning of the chapter. The user must heed warnings.



#### DANGER!

A hazard with a high degree of risk which, if not avoided, will result in death or serious injury.



#### WARNING!

A hazard with a medium degree of risk which, if not avoided, may result in death or serious injury.



#### CAUTION!

A hazard with a low degree of risk which, if not avoided, may result in minor or moderate injury.

#### NOTICE!

Denotes a hazard with a low degree of risk which, if not avoided, may result in minor or moderate damage to property or the environment.

### 3.2.4 Depiction of Notes



Notes point out important information which the user must heed when carrying out an instruction. Notes provide the user with additional information on a particular issue.

### 3.3 Related Documents











For information necessary for safe and trouble-free operation of the device and its accessories, read the respective user manuals of the accessories.



















### 3.4 Data Protection

Some device options save personal data for provision of services and patient care in encrypted form. The General Data Protection Regulation (EU) 2016/679 as well as further applicable guidelines, ordinances and laws are respected.

### 3.5 Symbols

The following table describes the symbols used in the user manual.

Symbol	Designation	Description
	Alarm on	Indicates in the status line that alarm suspension is deactivated. Indicates in the vital parameter field the alarm status "on" of the vital parameter.
	Alarm off	Indicates in the status line that alarm suspension is permanently activated. Indicates in the vital parameter field the alarm status "off" of the vital parameter.
	Alarm pause	Indicates in the vital parameter field that alarm suspension is temporarily activated.
	System alarm confirmed	Indicates an confirmed alarm of the alarm history in the status line.
	Upper alarm limit	Indicates the upper alarm limit of a vital parameter in the configuration dialogue.
	Lower alarm limit	Indicates the lower alarm limit of a vital parameter in the configuration dialogue.
	Heart rate (QRS complex)	Indicates the heart rate, measured via ECG- or therapy electrodes in the curve field.
	Heart rate (SpO <sub>2</sub> pulse)	Indicates the heart rate, measured via the oximetry sensor (SpO <sub>2</sub> ), in the curve field.
	QRS marker	Indicates in the curve field that the corpuls1 recognised a QRS complex.
	Pacer impulse mark	Indicates the pacer impulse mark of an implanted pacer in the curve field.
	Mission duration Calibration	The status line indicates the mission duration. Indicates in the vital parameter field that the pulse oximeter is calibrating.

Symbol	Designation	Description
	Confidence	Indicates in the vital parameter field a low confidence of the readings.
	Battery operation	Indicates in the status line that the corpuls1 operates on battery.
	Mains operation	Indicates in the status line that the corpuls1 operates on mains power.
	Screenshot status	Indicates in the status line that the screenshot view is open.
	Screenshot function	Indicates in the softkey line the screenshot function. NOTE: In the screenshot view, this symbol is not assigned to this softkey.
	Patient group Adult	Indicates in the status line that the patient group Adult has been selected.
	Patient group Child	Indicates in the status line that the patient group Child has been selected.
	Patient group Neonate	Indicates in the status line that the patient group Neonate has been selected.
	SD <sup>®</sup> card	Indicates in the status line that the corpuls1 stores mission data on the SD <sup>®</sup> card.
	Selected checkbox	Indicates in the configuration dialogue that the option of the checkbox has been selected.
	Unselected checkbox	Indicates in the configuration dialogue that the option of the checkbox is no longer selected.
	On/Off key	Indicates the On/Off key.
	Shock key	Indicates the Shock key.
	Main menu key	Indicates the Main menu key.
	Alarm key	Indicates the Alarm key.
	Pacer key	Indicates the Pacer key.
	Application part with defibrillation protection, type BF	Indicates a defibrillation-proof application part, type BF (Body Floating).
	Application part with defibrillation protection, type CF	Indicates a defibrillation-proof application part, type CF (Cardiac Floating).
	Manufacturer	Indicates the manufacturer of the corpuls1 on the rating plate.



















Symbol	Designation	Description
	Part number	Indicates the part number on the rating plate.
	Serial number	Indicates the serial number on the rating plate.
	Read the user manual	Indicates in the rating plate that the User Manual must be observed.
	Trash can	Indicates in the rating plate that the materials should not be disposed of via the household waste.
	Protection	Indicates in the rating plate that the corpuls1 is dust- and splash-proof.
	Protection	Indicates that the charging brackets are protected against water dripping at an angle 15 ° relative to vertical.
	Protection class I	Indicates that the device complies with the safety requirements of this protection class.
	Protection class II	Indicates that the charging brackets comply with the safety requirements of this protection class.
	External DC supply	Indicates that the corpuls1 can be supplied and/or charged with direct current via an external AC adapter.
	Recycling	Indicates that there is a recycling process for the materials.
	Medical product	Indicates that the item is a medical device.
	Repackaging	To identify that a modification to the original medical device packaging configuration has occurred.
	Importer	Indicates the entity importing the medical device into the locale.
	Distributor	Indicates the entity distributing the medical device into the locale.
	Unique Device Identifier	Indicates a carrier that contains Unique Device Identifier information.
	Functional test failed	Indicates that a functional test has failed.
	Functional test passed	Indicates that a functional test has been passed.

Table 3-2 Symbols

## 4 Safety

---

### 4.1 Safety instructions for the user

Safety instructions inform the the user of fundamental risks when operating the corpuls1.



---

The corpuls1 is protected against interferences that may stem from electro-surgical devices.

---



#### **DANGER!**

**Burning or explosion of the corpuls1 due to wrong environmental conditions during operation!**

May lead to severe injuries or death of users, patients or third parties.

- ▶ Do not operate the corpuls1 in the following situations: In the vicinity of readily inflammable anaesthetics or other inflammable substances as well as in an oxygen-rich (> 23%) environment.
- 



#### **DANGER!**

**Must not be used with conscious patients!**

Electric shock while using the defibrillator may have the following side effects for patients, users and third parties: cardiac arrhythmia, ventricular fibrillation (VF) or asystole.

- ▶ Do not use the defibrillator function of the corpuls1 if the patient is conscious.
  - ▶ Ventricular fibrillation (VT) or ventricular tachycardia (VT) may be detected even in patients who are conscious.
- 



#### **WARNING!**

**Use of a high-frequency surgical device!**

May lead to burn injuries of the user and patient due to leak currents from the high-frequency device to the therapy electrodes.

- ▶ Do not operate the corpuls1 in connection with a high-frequency surgical device or a microwave therapy device.
-

**WARNING!****Non-approved accessories!**

May result in increased electromagnetic emissions or reduced electromagnetic immunity of the corpuls<sup>1</sup> and result in erroneous functionality of the device. The effects of such an interference can be: Falsification of monitoring function, delay or abort of therapy.

- ▶ Only use accessories supplied by or approved by the manufacturer (refer to F Approved Accessories, Spare Parts and Consumables on page 218).

**WARNING!****System crash!**

Can lead to the user no longer being able to operate the corpuls<sup>1</sup>.

- ▶ Hold down **On/Off** key for 8 s.
- ▶ If necessary, remove battery and re-insert.



If the user removes the battery during operation or holds down the **On/Off** key for longer than 8 s, the corpuls<sup>1</sup> cannot store the current mission data correctly.

**WARNING!****Continuous operation of the corpuls<sup>1</sup>!**

If the user keeps the corpuls<sup>1</sup> running after each patient mission, a permanent availability of the system cannot be guaranteed.

- ▶ Switch off the corpuls<sup>1</sup> regularly (after max. 12 h) and restart, in particular after each patient mission.

**CAUTION!****Electromagnetic fields of other devices!**

Can cause distortions in the ECG of the corpuls<sup>1</sup> and impede ECG analysis so that the release of a shock is not possible or the function of the external pacer is not available. Can lead to malfunctions of other devices in the vicinity.

- ▶ Do not store the corpuls<sup>1</sup> in the immediate vicinity of other devices or stacked with other devices.
- ▶ Check before the mission, if malfunctions occur in the corpuls<sup>1</sup> or in other devices.

**NOTICE!****Conductive parts between electrodes and connectors!**

Can cause malfunctions in the corpuls<sup>1</sup> and in other devices. Can lead to failure of the corpuls<sup>1</sup> or of other devices.

- ▶ Make sure that the conductive parts of electrodes and attached plugs do not touch other conductive parts including the ground. Other conductive parts can be, e. g. metal parts of stretchers.

**WARNING!****Wrong device arrangement!**

Avoid using the corpuls<sup>1</sup> in immediate vicinity of other devices or stacked with other devices, because this could lead to faulty operation of the corpuls<sup>1</sup>.

- ▶ Do not store corpuls<sup>1</sup> in the immediate vicinity of other devices or stacked with other devices.
- ▶ If use as described above is nevertheless necessary, observe the corpuls<sup>1</sup> and other devices to ensure correct functioning.

**WARNING!****Wrong use of portable radios!**

The use of portable radios, including accessories as e. g. antenna cables and external antennas in to short a distance to the corpuls<sup>1</sup> can lead to a decrease of performance characteristics of the corpuls<sup>1</sup>.

- ▶ Do not use portable and mobile HF communications equipment at a distance less than 30 cm (or 12 in ) to the parts and leads of the corpuls<sup>1</sup> indicated by the user.

**WARNING!****Electric shock due to mains voltage!**

If the corpuls<sup>1</sup> is operated with an unauthorized power supply unit without protective conductor, an electric shock is not excluded.

- ▶ To avoid the risk of electric shock, connect the corpuls<sup>1</sup> only to a mains voltage supply with a protective conductor.

## 4.2 Warning- and Notice Labels on the Device

The following table describes the warning- and notice labels on the housing of the corpuls<sup>1</sup>.

Warning-/Notice labels	Description
	Mind the user manual.



Warning-/Notice labels	Description
	Defibrillation-proof application part, type BF (Body Floating). Insulated application parts of this type are approved for external and internal application at the patient.
	Defibrillation proof application part, type CF (Cardiac Floating). Insulated application parts of this type are approved for immediate application at or in the heart of the patient.
 <b>56060.06300</b> <b>T6.3 AH</b>	Safety plate of the charging bracket and the adapter charging bracket.

Table 4-1 Warning- and Notice Labels on the Device

## 5 Device Description

---

### 5.1 Description of Functions

#### 5.1.1 Monitoring Functions

The corpuls1 provides the following monitoring functions:

- ECG

Optional:

- Pulse oximetry (PP, PI, SpO<sub>2</sub>)
- Extended Oximetry (SpCO<sup>®</sup>, SpHb<sup>®</sup>, SpMet<sup>®</sup>)

**ECG** The 4-pole ECG monitoring cable allows to obtain the following extremity leads:

- Einthoven (I, II, III)
- Goldberger (aVR, aVL, aVF)

The corpuls1 represents these extremity leads on the screen.

**Pulse oximetry** Besides the peripheral pulse rate (PR), pulse oximetry measures the perfusion index (PI) and the arterial oxygen saturation (SpO<sub>2</sub>).

The extended oximetry option depends on which oximetry module is installed in the device (only Masimo Rainbow SET Technology) and includes the following measurement options:

- Methaemoglobin levels (SpMet<sup>®</sup>) in percent
- Carboxyhaemoglobin levels (SpCO<sup>®</sup>) in percent
- Measurement of total haemoglobin levels (SpHb<sup>®</sup>) in g/dl or mmol/l

#### 5.1.2 Therapeutic Functions

The corpuls1 provides the following therapeutic functions:

- Defibrillation
- Cardioversion
- Pacing (Option)

**Defibrillation and Cardioversion** The corpuls1 defibrillator operates with a biphasic pulse and has the following two operating modes:

- Automatic external defibrillation (AED mode)
- Manual defibrillation and cardioversion (manual mode)

In AED mode, the corpuls1 supports the user by an automated ECG analysis and verbal instructions (configurable). Additionally, a metronome (configurable) and the corPatch CPR sensor (option, disposable adhesive sensor) support the thorax compressions during cardio-pulmonary resuscitation. If the corpuls1 recommends a shock after ECG analysis, the user has to trigger the defibrillation shock.

In manual mode, the user has full freedom of action and decision-making. The metronome (configurable) is also available in this mode as well as the optional corPatch CPR function.

In case of a manual defibrillation, the corpuls1 releases the shock energy asynchronously. In case of a cardioversion, the corpuls1 releases the shock energy synchronously to the QRS complex. Cardioversion is intended to revert certain arrhythmias of the heart to the normal rhythm.

#### Therapy electrodes

The user can perform defibrillation with the following therapy electrodes:

- corPatch easy electrodes (disposable adhesive electrodes)
- Shock paddles
- Shock spoons

#### Energy selection

In manual mode there are two different options for selecting the energy level:

- Softkeys  
The softkeys allow a quick selection of predefined energy settings (depending on which electrodes are connected) or selection in individual steps.
- Shock paddles  
With short-circuited shock paddles, the user can select the energy levels by pressing one of the shock paddle buttons. This function allows the same energy selection as with the softkeys.

**Pacing (Option)** By external electrical stimulation, the external pacer of corpuls1 can supplement and positively influence the function of the heart muscle. The pacer emits pacing pulses to the patient's heart muscle via the corPatch easy electrodes. The electrodes are placed in the anterior and posterior position in this case.

With the pacer function, the FIX and DEMAND operating modes are available. In the FIX operating mode, the pacer stimulates the heart muscle regardless of the patient's own heart rate. In DEMAND mode, the pacer only stimulates when the patient's heart rate, obtained via the 4-pole ECG monitoring cable, differs from the pre-set pacing frequency. The automatic recognition of QRS complexes prevents pacing during the vulnerable phase of the heart.

## 5.2 Connections

The interfaces of the corpuls1 allow to connect various cables and sensors.

### 5.2.1 Front Side of the Device

At the front side of the device the following interfaces are located:

- Therapy socket



Figure 5-1 Interfaces at the front side of the device (illustration without pacer option)

1 Therapy socket

The therapy socket allows to connect therapy electrodes to the (refer to 11.8 Connecting Therapy Electrodes to the Device on page 101).

### 5.2.2 Rear Side of the Device

At the rear side of the device the following interfaces are located:

- Data interface socket
- Magnetic contact field interface

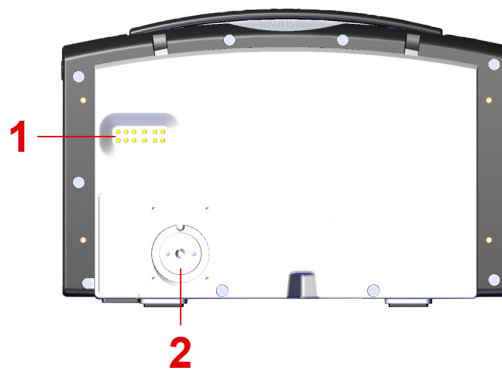

Figure 5-2 Interfaces at the rear side of the device

1 Data interface socket (in preparation)  
2 Magnetic contact field interface

The magnetic contact field allows to operate the corpuls1 in mains operation (refer to 5.5 Mains Operation on page 23) and to charge the battery (refer to 6.3 Charging the Battery on page 29).



### 5.2.3 Right Hand Side of the Device

**Without corPatch CPR** At the right hand side of the device the following interfaces are located:

- Oximetry interface
- ECG-M interface



Figure 5-3 Interfaces at the right hand side of the device (without corPatch CPR disposable sensor)

- 1 Oximetry interface
- 2 ECG-M interface

The oximetry interface allows to connect a pulse oximetry sensor (refer to 10.5.2 Pulse Oximetry Sensor (Accessories) on page 67). The interface ECG-M allows to connect ECG electrodes (refer to 10.5.1 ECG Monitoring Cable (Accessories) on page 67).

**With corPatch CPR** At the right hand side of the device the following interfaces are located:

- Oximetry interface
- CPR interface
- ECG-M interface

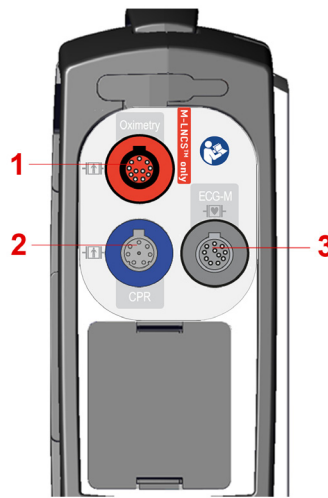

Figure 5-4 Interfaces at the right hand side of the device (with corPatch CPR disposable sensor)

- 1 Oximetry interface
- 2 CPR interface
- 3 ECG-M interface

The oximetry interface allows to connect a pulse oximetry sensor (refer to 10.5.2 Pulse Oximetry Sensor (Accessories) on page 67). Socket CPR allows to connect a corPatch CPR disposable sensor (refer to 11.8.2 corPatch CPR Disposable Sensor (Accessories) on page 103). The interface ECG-M allows to connect ECG electrodes (refer to 10.5.1 ECG Monitoring Cable (Accessories) on page 67).

### 5.2.4 Bottom Side of the Device

At the bottom side of the device the following interfaces are located:

- LAN interface

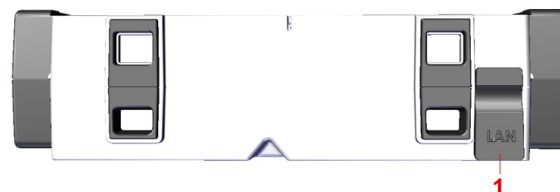

Figure 5-5 LAN interface

- 1 LAN interface

The LAN interface allows to connect a LAN cable for service purposes.

### 5.3 Display and Operation Elements

The following illustration gives an overview of the display and operating elements of the corpuls1.

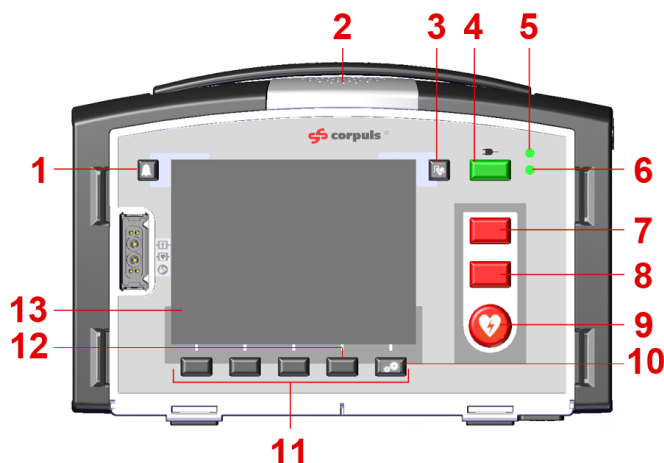

Figure 5-6 Display- and operating elements (Illustration with pacer option)

Item	Element	Description
1	Alarm key	The following functions are available: <ul style="list-style-type: none"> <li>Calling up the alarm history (refer to 7.10 Alarm History on page 48).</li> <li>Confirming alarms (refer to 7.10 Alarm History on page 48).</li> <li>Suspending or silencing patient alarms (refer to 7.8 Alarm Suspension on page 47).</li> </ul>
2	Alarm light	Indicates alarms visually and acoustically (refer to 5.6 Alarm Design on page 23).
3	Pacer key	Allows to call up or close the pacer mode (refer to 11.5.3 Overview Pacer mode on page 92). The <b>Pacer</b> key is only available in corpuls1 devices equipped with the pacer option.
4	On/Off key	Allows to enable or disable the corpuls1 (refer to 6.2 Switching the Device on and off on page 26).
5	LED Battery status	Indicates the charging status. Glow orange in mains operation when battery is being charged. It may take up to 60 s until the LED Battery status is glowing. Glow yellow in mains operation when battery is fully charged. <i>NOTE:</i> Does not glow when operating on battery power.





Item	Element	Description
6	LED operating status	Indicates the operating status. Glow green when corpuls1 is switched on. Indicates full operational readiness of the corpuls1 when the corpuls1 is switched off (flashes up regularly) or whether errors have occurred (no flashes). (refer to 15.4.2 Automatic Self-test on page 171).
7	<b>Defib</b> key	Allows to call up the AED mode or manual mode.
8	<b>Analyse</b> key	Allows to start the ECG analysis or to call up the defibrillation mode.
9	<b>Shock</b> key	Allows to deliver a shock or to call up the defibrillation mode
10	Softkey [Menu] or key <b>Main menu</b> 	Allows to call up the main menu in monitoring mode with a short pressure and in pacer mode and in the defibrillation modes with a long pressure.
11	Softkeys	Allow to navigate in menus and to change settings. The softkeys are assigned different functions, depending on the current operating mode. The respective softkey fulfills the function that is assigned in the user interface.
12	Softkey 	Allows to create a screenshot in monitoring mode, defibrillation mode and pacer mode (refer to 7.7 Screenshot Function on page 45). <i>NOTE:</i> Although the icon  is not indicated, the screenshot function is also available in defibrillation modes and pacer mode.
13	Display	Shows the user interface of the corpuls1.

Table 5-1 Display and operating elements

## 5.4 Battery Operation

Battery operation allows a mobile and flexible use of the corpuls1. The screen shows the symbol for battery operation and the remaining running time of the battery  257 min (refer to 7.1 Structure of the User Interface on page 33).

If the charging status of the battery is < 20%, the corpuls1 issues an alarm (refer to 17 Alarms and Messages on page 180).

## 5.5 Mains Operation

Mains operation allows a stationary use of the corpuls<sup>1</sup> and the charging of the battery (refer to 6.3 Charging the Battery on page 29). The screen shows the symbol for mains operation and the charging status of the battery  61% (refer to 7.1 Structure of the User Interface on page 33).

The user can operate the corpuls<sup>1</sup> on mains power as follows:

- With an AC adapter with magnetic clip (MagCode) (refer to F Approved Accessories, Spare Parts and Consumables on page 218).
- With a charging bracket (refer to 18 Charging brackets (Accessories) on page 201).

## 5.6 Alarm Design

### 5.6.1 Warnings

The following warnings inform the user of possible hazards when using the corpuls<sup>1</sup>.



#### WARNING!

#### Potential danger due to inappropriate alarm presettings in area of application!

If the user operates the device in an area of application other than the usual, the alarm settings may cause misunderstandings.

- ▶ Adjust alarm settings.

The alarms are classified in following groups:

- Patient alarms
  - Alarms for vital parameters (physiological alarms)
  - Alarms indicating loose electrodes and sensors (technical alarms)
- System alarms
  - All other alarms (technical alarms)

The corpuls<sup>1</sup> signals alarms over following device elements:

- Status line/Alarm line (Alarm history) (refer to 7.10 Alarm History on page 48)
- Highlighted vital parameter field – at patient alarms (additional to status line/alarm line)
- Alarm light
- Alarm tone

Alarms are classified according to their priorities high, medium and low. The following table shows how the alarm history and the alarm light indicate and signal the alarm priorities.

Signal	High priority	Medium priority	Low priority
Statusline/Alarmline (Alarm history)	Head of alarm line: "!!!" (Highlighted in red - not confirmed) "!!!" (greyed out - confirmed)	Head of alarm line: "!!!" (Highlighted in red - not confirmed) "!!!" (greyed out - confirmed)	Head of alarm line: "!'" (Highlighted in blue - not confirmed) "!'" (greyed out - confirmed)

Signal	High priority	Medium priority	Low priority
Alarm light	Flashing red and tone sequence.	Flashing yellow and tone sequence.	Flashing cyan and tone sequence.

Table 5-2 Indication of alarm priorities by means of alarm history and alarm light

## 5.6.2 Alarming in the Status Line

If the corpuls1 signals new alarms in the status line/alarm line, the corpuls1 shows these alarms first as follows:



Figure 5-7 Example: Alarm line after a new alarm is issued

This illustration shows the number of not-confirmed alarms. The colour indicates the priority of the not-confirmed alarm. The status line shows the current time or the deployment time alternating every 5 s.

If the user opens the alarm history and confirms alarms (refer to 7.10 Alarm History on page 48), the corpuls1 shows the following alarm list:

Confirm alarms	18:59	00:03:56	385 min
!! ECG cable loose			18:58:46
!! No Oxi cable			18:58:44
!!! Therapy electrode cable loose			<del>18:58:34</del>

Figure 5-8 Example: Open alarm history

The open alarm history shows the user prompt **Confirm alarms** highlighted in blue in the first line. In the following, the not-confirmed alarms are listed and highlighted according to their priority ("!!!"/red - high; "!!"/yellow - medium; "!"/blue - low), with the first alarm entry marked. Below those, the already confirmed alarms are listed, sorted by priority. Confirmed alarms are marked with a crossed-out bell symbol .



Certain technical alarms (system alarms) are latching alarms that will not disappear even after confirmation, as long as the cause is present. All other technical alarms (patient alarms) are non-latching and disappear after a restart of the corpuls1.

The corpuls1 offers two options to suppress an alarm:

- Alarm suspension (optical signal and alarm tone)
- Alarm tone silencing function



Both types of alarm exposure depend on the settings configured by the user OPERATOR. The user OPERATOR can only activate one of these two options, not both simultaneously.

#### Alarm suspension

The general alarm suspension can be activated in every operation mode with the **Alarm** key. The general alarm suspension inactivates the optical signal at the alarm light and the alarm tone for all alarms. The alarm history lists all old alarms and new technical alarms.

In defibrillation mode, all physiological alarms are suspended automatically. That means, physiological alarms do not trigger the optical signal at the alarm light, no alarm tone and are not listed in the alarm history.

When quitting the defibrillation mode and the general alarm suspension is not activated, the corpuls1 checks all physiological alarms and signals them again, if necessary.

#### Alarm tone silencing function

The alarm tone silencing function only inactivates the alarm tone from all former active alarms. As soon as a new alarm is issued, the alarm tone silencing function is deactivated again. The corpuls1 also signals all former alarms again.

#### Reminder signal

The reminder signal indicates that the general alarm suspension has been activated by pressing **Alarm**. If the reminder signal is activated, the alarm light flashes up white and a tone is sounding. The reminder signal is repeated at a time interval of 60 s.

If the reminder signal has been activated (Settings by user OPERATOR) and the general alarm suspension has been activated, the corpuls1 issues the reminder signal.



The particular suspension of a physiological alarm in a vital parameter field does not trigger the reminder signal.

### 5.6.3 Alarming in the Vital Parameter Field

With patient alarms, the pertaining vital parameter field is highlighted in colour, in addition to the alarming in the status-/alarm line.

If vital parameter values are outside the alarm limits, the corpuls1 triggers a physiological alarm. This is not true for defibrillation mode.

#### Alarm suspension Vital parameter field

The suspension of physiological alarms in a vital parameter field (refer to 7.4 Vital Parameter Context Menu on page 38) inactivates the alarm output in the alarm history, the alarm tone and the optical signal at the alarm light. The vital parameter field remains inverted/highlighted.



Deactivation of the general alarm suspension by pressing the **Alarm** key (refer to 7.4.4 Switching off a Vital Parameter Alarm on page 40) does not deactivate the alarm suspension of a specific vital parameter alarm.

## 6 Commissioning

---

### 6.1 Unpacking the Device

Before the user can operate the corpuls1, the user has to unpack the corpuls1.



---

In case the corpuls1 is damaged or if parts of the corpuls1 or of the accessories are missing, immediately contact your authorised service and sales partner.

---

*To make the device fully operational, proceed as follows:*

1. Take the corpuls1 out of the transport box.
2. Remove packaging material.
3. Check if all ordered parts have been delivered.
4. Check the device corpuls1 for damage.
5. Inserting the battery (refer to 6.4 Replacing the Battery on page 30).
6. Fixate (refer to 19.2 Packing and Fixating the left Accessory Bag on page 206) and pack (refer to 19.3 Packing and Fixating the right Accessory Bag on page 207) the accessory bags.

### 6.2 Switching the Device on and off

To operate the corpuls1, the user has to switch on the corpuls1. After the mission, the user can switch off the corpuls1.

#### 6.2.1 Switching on the Device

The corpuls1 can start in Monitoring mode, AED mode or Manual mode. The start modes depend on the settings configured by the user OPERATOR.

*To switch the device on, proceed as follows:*

1. Press On/Off key.



---

To reach operational status, the corpuls1 needs up to 20 s.

---

*The start user interface appears.*

*The user can select the patient group indicated by the symbol Patient group in the status line top right.*



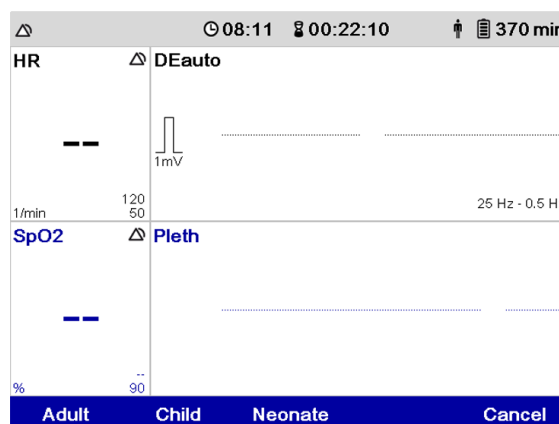

Figure 6-1 Start Screen (monitoring mode)

The corpuls1 automatically closes the patient group selection after an internally defined period of time. Only if no therapy electrodes are connected, the selection dialogue remains. The selection dialogue remains until the user has selected a patient group.

The user can also close the selection dialogue of patient group by pressing e. g. the **Defib** key. The corpuls1 adopts then the standard value of the therapy electrodes.

## 6.2.2 Switching the Device off

After the mission, the user can switch off the corpuls1.

*To switch the device off, proceed as follows:*

1. Press On/Off key.

*The confirmation prompt **Power Off?** appears.*

*When the pacer is active, the confirmation prompt **Switch off pacer? - Power Off?** appears in the message line.*



To abort the process, press softkey [Cancel]. If no softkey is pressed, the message disappears automatically after 10 s. The corpuls1 stays switched on.

2. Press softkey [OK].
3. One of the following situations occurs:
  - a) The corpuls1 switches off.
  - b) The display shows due service events (refer to 16 Service Events on page 178). Confirm service events by pressing the softkey [Confirm]. The corpuls1 switches off.

### 6.2.3 Automatic Shutdown

If the remaining running time of the battery is 10 min or less, the corpuls<sup>1</sup> shuts down automatically after 20 s. The message **System shutting down in 20 s** appears in the message line.

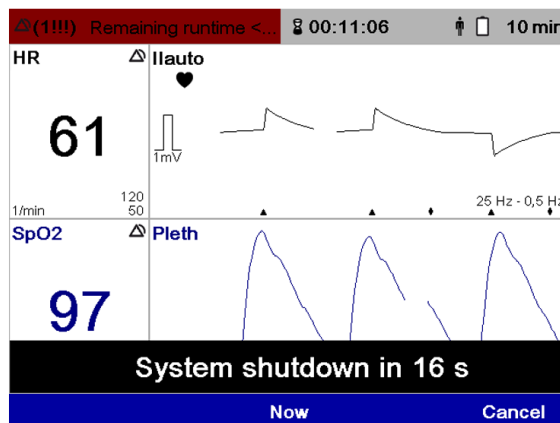

Figure 6-2 Message before automatic shut down

At the same time as the message, the alarm message **Remaining runtime < 10 min** appears.



The message **System shutdown in XX s** appears in all modes. In pacer mode, this message appears only in the calling up phase, not in the pacing phase (even during monitoring mode). In pacer mode, only the parallel alarm message appears.

After the countdown is done, the message **System is shutting down ...** appears in the message line.

The user can accelerate or cancel the shutdown process.

*To accelerate or cancel the shutdown process, proceed as follows:*

1. Press softkey [Now] to save event data and immediately shut down the corpuls<sup>1</sup>.
2. To abort the process, press softkey [Cancel].

#### NOTICE!

#### Continued operation after initiated shutdown!

If the user prevents automatic shutdown and operates the corpuls<sup>1</sup> until the battery is completely empty, mission data may be lost.

- ▶ Acknowledge automatically initiated shutdown to enable the shutdown.

### 6.3 Charging the Battery

To charge the battery, the following options are available:

- AC adapter with magnetic clip (MagCode)
- Charging brackets

The battery can be charged with the corpuls1 switched on or off. During the charging process, the battery remains inserted in the corpuls1. The LED Battery status indicates the current charging status. The screen of the switched-on corpuls1 shows the charging status of the battery. The user can operate the corpuls1 while charging is in progress.



If the user connects the corpuls1 to a power supply (AC adapter or charging bracket) and no battery is inserted, the corpuls1 automatically switches on and issues an alarm message that the battery is missing.

How to charge the battery via AC adapter with magnetic clip (MagCode) is described in the following. For information how to charge the battery in a charging bracket, refer to the chapter Charging Brackets (refer to 18 Charging brackets (Accessories) on page 201).

Prerequisite:

- The battery is inserted (refer to 6.4 Replacing the Battery on page 30)
- The AC adapter is connected to a power supply

*To charge the battery, proceed as follows:*

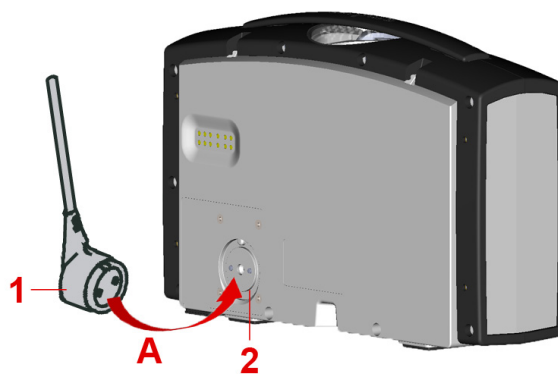

Figure 6-3 Connect the magnetic clip (MagCode) to the magnetic contact field interface

- 1 Magnetic clip (MagCode)
- 2 Magnetic contact field interface

1. Connect (item A) the magnetic clip (item 1) to the magnetic contact field interface (item 2). The cable of the magnetic clip has to point upwards. The magnetic clip automatically snaps into place at the magnetic contact field.

*The status line shows the symbol for mains operation. The LED Charging status glows orange as long as the corpuls1 charges the battery.*

## 6.4 Replacing the Battery

The user can replace the battery.



### WARNING!

#### Improper handling during battery replacement!

Can lead to patient or user injury as a result of electric shock, burns, fire or explosion.

- ▶ Only change the battery by adequately trained personnel.
- ▶ Do not short circuit the battery.
- ▶ Do not deform or disassemble battery.
- ▶ Do not throw the battery into fire and keep away from welding or soldering.
- ▶ Replace aged or damaged battery and discard immediately.

Prerequisite:

- corpuls1 is switched off (refer to 6.2.2 Switching the Device off on page 27)

*To replace the battery, proceed as follows:*

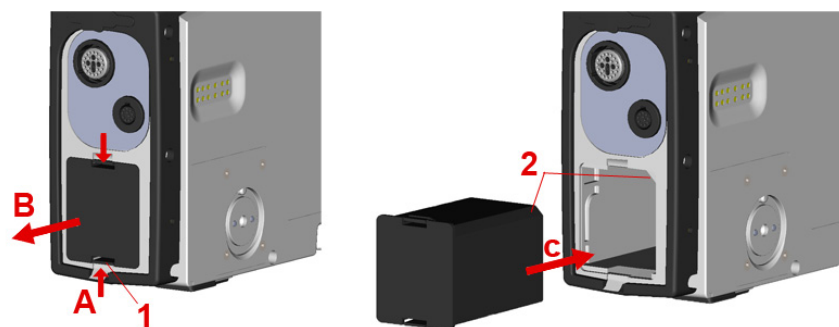

Figure 6-4 Replace battery

- 1 Locking clip
- 2 Guidance groove

1. Pinch together (item A) both locking clips (item 1).  
*The battery is unlocked.*
  2. Pull out the battery (item B).
  3. Insert the new battery into the battery compartment and push (item C).
- Both locks (item 1) engage audibly.

## 6.5 Inserting the SD Card

To be able to store mission data on a SD card, the user has to have a SD card inserted during the mission.



Even if the write protection of the SD card is enabled, the corpuls1 can save mission data on the SD card.



Exclusively use authorised SD cards. The SD card has to be formatted with the FAT32 file system.

*To insert the SD card, proceed as follows:*



Figure 6-5 Inserting SD card (pictured: right side of device without corPatch CPR)

1 SD card slot

1. Remove the protective cover from the SD card slot.
2. Push the SD card with the contacts facing upwards into the SDTM card slot (item 1).

*The SD card snaps into place with an audible click.*

3. Replace the cover of the SD card slot.

*The SD card is inserted in the device.*

## 6.6 Removing the SD Card

To view the mission data with , the user has to remove the SD card after the mission is finished.

*To remove the SD card from the slot, proceed as follows:*



Figure 6-6 Removing SD card (pictured: right side of device without corPatch CPR)

1 SD card slot

1. Remove the protective cover from the SD card slot.
2. Push the SD card further into the SD card slot (item 1).

*The SD card disengages with a click.*

3. Remove the SD card.
4. Replace the cover of the SD card slot.

*The SD card is removed.*



---

Heed the following warning (refer to 12.1 Mission Data Storage on page 110).

---

## 7 User Interface in Monitoring Mode

This chapter shows the user interface and instructs the user how to operate the corpuls1 in monitoring mode. The monitoring mode allows the monitoring of the patient by means of ECG monitoring (refer to 10.3 ECG Monitoring on page 62) and pulse oximetry monitoring (refer to 10.4 Pulse Oximetry Monitoring (Option) on page 63).

### 7.1 Structure of the User Interface

The following illustration shows the structure of the user interface in monitoring mode.

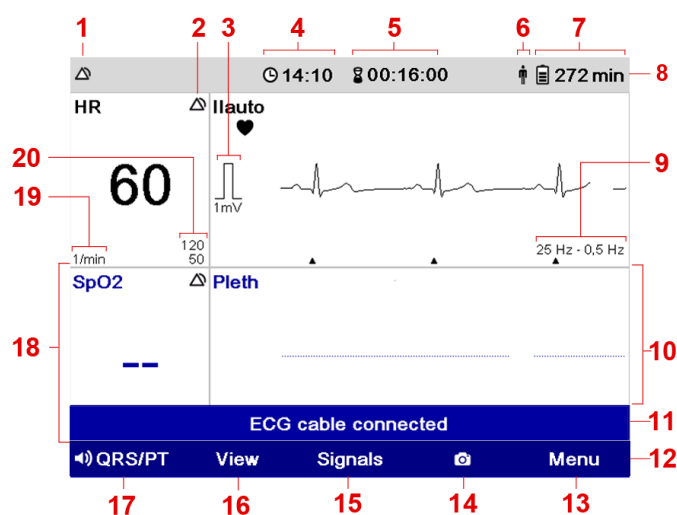





Figure 7-1 Structure of the user interface in monitoring mode

Item	Element	Description
1	Alarm suspension	Indicates whether the alarm suspension has been activated or deactivated (refer to 7.8 Alarm Suspension on page 47).
2	Alarm status of the vital parameters	Indicates if the alarm for a vital parameter has been enabled (refer to 7.4.5 Switching on a Vital Parameter Alarm on page 40) or disabled (refer to 7.4.4 Switching off a Vital Parameter Alarm on page 40).
3	Amplitude settings	Indicates the amplitude setting (refer to 7.5.2 Overview Curve Context Menu on page 42).
4	Time	Indicates the current time (refer to 13.9.2 Submenu item Settings on page 133).
5	Mission duration	Indicates the duration of the mission.

Item	Element	Description
6	Patient group	Shows the selected patient group (refer to 13.8.2 Submenu item Patient class/-group on page 130).
7	Battery operation/Mains operation	Shows either the symbol for battery operation and the remaining running time (refer to 5.4 Battery Operation on page 22) or the symbol for mains operation and the charging status (refer to 5.5 Mains Operation on page 23).
8	Status Line	Indicates the operating status of the corpuls <sup>1</sup> . Shown are: Alarm suspension, alarm history, current time, mission duration, patient group and power supply mode.
9	Filter settings	Displays the filter settings for the ECG filter (refer to 14.2.1 Submenu item Filter on page 140).
10	Curve field	Displays a curve. If a curve gets no valid signal, the curve field shows a dotted line. If a valid signal in a curve field is larger than the display area, the curve field shows a dotted line at the upper and lower borders.
11	Message line	Indicates a message.
12	Softkey line	Indicates the current assignment of the softkeys.
13	Softkey [Menu]	Allows to open the main menu (refer to 7.2.1 Opening the Main Menu on page 35).
14	Softkey 	Allows to create a screenshot in monitoring mode, defibrillation mode (symbol  ) and defibrillation mode and pacer mode (in pacer mode without symbol  ) (refer to 7.7 Screenshot Function on page 45).
15	Softkey [Signals]	Allows to open the parameter- and curve context menu (refer to 7.4.2 Overview Vital Parameter Context Menu on page 39).
16	Softkey [View]	Allows to change the view (refer to 7.6 Softkey Context Menu on page 43).
17	Softkey [QRS]	Allows to change the volume of the QRS/PT tone (refer to 7.6.1 Softkey Context Menu QRS/PT on page 44).



Item	Element	Description
18	Vital parameter field	Displays a vital parameter. If a vital parameter gets no valid signal, the vital parameter field shows two dashes. If a vital parameter value is measured with low confidence, the vital parameter field shows a ? (question mark).
19	Unit of the vital parameter	Shows the measuring unit of a vital parameter.
20	Alarm limits	Indicates the upper and lower alarm limits of the vital parameters (refer to 13.3 Menu item Alarms on page 113). When an alarm limit has been deactivated via the main menu Settings, the field shows two dashes instead.

Table 7-1 Elements of the user interface in monitoring mode



The symbol ▲ in the curve field indicates a QRS marker.

The black flashing symbol ♥ in the curve field indicates a QRS complex. The blue flashing symbol ♥ in the curve field indicates the heart rate measured via the pulse oximetry sensor.

The corpuls1 detects pacemaker pulses coming from another source (e. g. from a pacemaker implanted in the patient) via ECG electrodes and displays them in the curve fields with a lozenge symbol ◆. If the ECG is derived from therapy electrodes (DE lead), these pacemaker marks are not displayed.

## 7.2 Main Menu

In the main menu, the user can change the settings (refer to 13 Settings Main Menu on page 112).



Settings that are reserved for the user OPERATOR cannot be changed by the user DEFAULT and MAN. DEFIB. (refer to 14 Settings Main menu (User level OPERATOR) on page 138)

### 7.2.1 Opening the Main Menu

The user can open the main menu in every operating mode.

*To open the main menu in monitoring mode, proceed as follows:*

1. Press softkey [OK] (refer to 7.1 Structure of the User Interface on page 33).

*The main menu has been opened.*

### 7.2.2 Overview Main Menu

The following illustration gives an overview of the main menu.

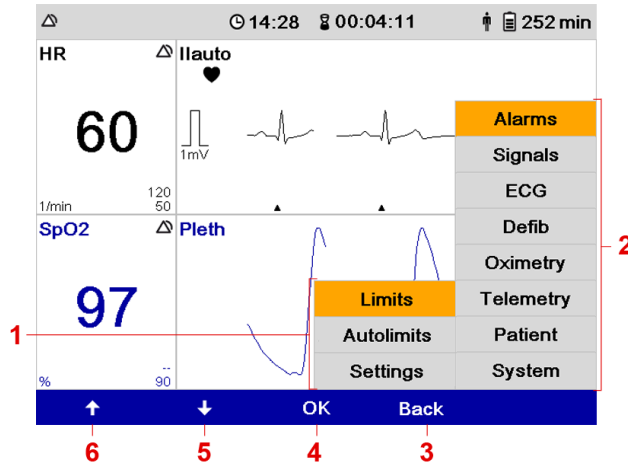

Figure 7-2 Overview main menu

Item	Element	Description
1	Submenu	Shows submenu items.
2	Main Menu	Shows menu items.
3	Softkey [Back]	The following functions are available: <ul style="list-style-type: none"> <li>Closing menus.</li> <li>Closing submenus.</li> </ul>
4	Softkey [OK]	The following functions are available: <ul style="list-style-type: none"> <li>Selecting menu items.</li> <li>Selecting submenu items.</li> </ul>
5	Softkey [Down]	The following functions are available: <ul style="list-style-type: none"> <li>Navigating between the menu items.</li> <li>Navigating between the submenu items.</li> </ul>
6	Softkey [Up]	The following functions are available: <ul style="list-style-type: none"> <li>Navigating between the menu items.</li> <li>Navigating between the submenu items.</li> </ul>

Table 7-2 Overview main menu

### 7.2.3 Navigating in the Menu

Via the softkeys the user can navigate in the menu.

Prerequisite:

The menu has been opened (refer to 7.2.1 Opening the Main Menu on page 35)

To navigate in the menu, proceed as follows:

1. Navigate to the required menu item by pressing the softkey [Up] or [Down].  
*The menu item is marked in yellow.*
2. To select the menu item, press softkey [OK].  
*The submenu has been opened.*



To close the submenu, press softkey [Back].

3. Navigate to the required submenu item by pressing the softkey [Up] or [Down].  
*The submenu item is marked in yellow.*
4. To select the submenu item, press softkey [OK].  
*The settings for the submenu item have been opened (refer to 13 Settings Main Menu on page 112).*

### 7.3 Overview Parameter- and Curve Context Menu

In the vital parameter- and curve context menu the user can change the settings for the vital parameters and curves. The user can change additional settings in the menu (refer to 13.4 Menu item Signals on page 118).

The following illustration gives an overview of the parameter- and curve context menu.

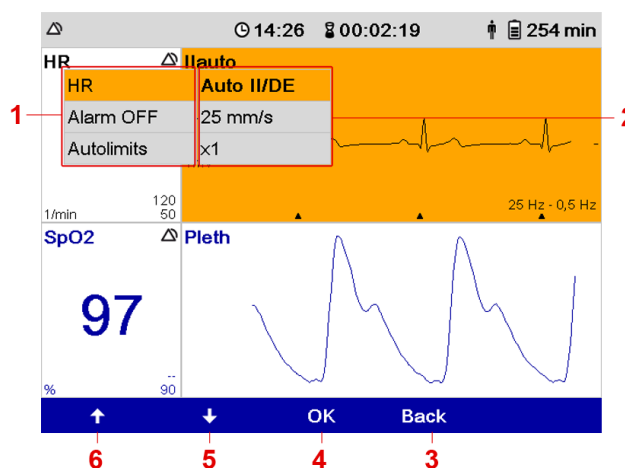

Figure 7-3 Overview parameter- and curve context menu

Item	Element	Description
1	Vital parameter context menu	Allows to change the settings for a vital parameter (refer to 7.4 Vital Parameter Context Menu on page 38).
2	Curve context menu	Allows to change the settings for a curve (refer to 7.5 Curve Context Menu on page 41).

Item	Element	Description
3	Softkey [Back]	The following functions are available: <ul style="list-style-type: none"> <li>• Closing a vital parameter context menu.</li> <li>• Closing a curve context menu.</li> <li>• Cancelling the selection of settings.</li> </ul>
4	Softkey [OK]	The following functions are available: <ul style="list-style-type: none"> <li>• Opening a vital parameter context menu.</li> <li>• Opening a curve context menu.</li> <li>• Selecting and confirming settings.</li> </ul>
5	Softkey [Down]	The following functions are available: <ul style="list-style-type: none"> <li>• Navigating between vital parameters and curves.</li> <li>• Navigating between settings.</li> </ul>
6	Softkey [Up]	The following functions are available: <ul style="list-style-type: none"> <li>• Navigating between vital parameters and curves.</li> <li>• Navigating between settings.</li> </ul>

Table 7-3 Overview parameter- and curve context menu

## 7.4 Vital Parameter Context Menu

The user can change settings for the vital parameters in the vital parameter context menu.

### 7.4.1 Open Vital Parameter Context Menu

The user can open the the vital parameter context menu only in monitoring mode.

*To open the vital parameter context menu, proceed as follows:*

1. Press softkey [Signals] (refer to 7.1 Structure of the User Interface on page 33).
2. Navigate to the required vital parameter field by pressing the softkey [Up] or [Down].

*The required vital parameter field is marked in yellow.*

3. Press softkey [OK].

*The vital parameter context menu is open.*

### 7.4.2 Overview Vital Parameter Context Menu

The following illustration gives an overview of the vital parameter context menu.

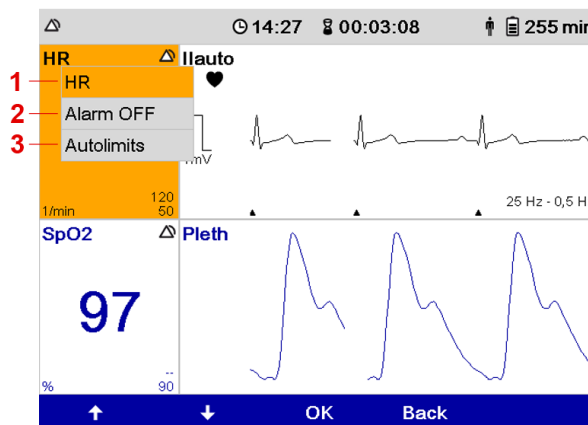

Figure 7-4 Overview Vital parameter context menu

Item	Element	Description
1	List box <i>Vital parameter</i> (here: HR)	Allows to change the vital parameters for a vital parameter field (refer to 7.4.3 Changing Vital Parameter Settings on page 39).
2	List box <i>Vital parameter alarm</i> (here: Alarm OFF)	Allows to disable (refer to 7.4.4 Switching off a Vital Parameter Alarm on page 40) or enable (refer to 7.4.5 Switching on a Vital Parameter Alarm on page 40) the alarm for a vital parameter.
3	List box <i>Vital parameter autolimits</i> (here: <i>Auto. Limits</i> )	Allows to adopt the configured auto limits for a vital parameter (refer to 7.4.6 Adopting Auto Limits on page 41).

Table 7-4 Overview Vital parameter context menu



There are no alarm limits for the vital parameter perfusion index (PI). Therefore the list box *Vital parameter autolimits* is not available.

### 7.4.3 Changing Vital Parameter Settings

Allows to change the vital parameters for a vital parameter field.

Prerequisite:

- The vital parameter context menu is open (refer to 7.4.1 Open Vital Parameter Context Menu on page 38)

**To change a vital parameter, proceed as follows:**

1. Navigate to the list box [Vital parameter] by pressing the softkey [Up] or [Down].

*The list box Vital parameter is marked in yellow.*

2. Press softkey [OK].

*The vital parameter is emphasised in bold font.*

3. Navigate to the required vital parameter by pressing the softkey [Up] or [Down].

*The vital parameter is displayed.*

4. Press softkey [OK].

*The vital parameter field shows the vital parameter.*

#### 7.4.4 Switching off a Vital Parameter Alarm

The user can disable the switched on physiological alarm for a vital parameter.

Prerequisite:

- The vital parameter context menu is open (refer to 7.4.1 Open Vital Parameter Context Menu on page 38)

**To disable the alarm for a vital parameter, proceed as follows:**

1. Navigate to the list box *Alarm OFF* by pressing the softkey [Up] or [Down].

*The list box Alarm OFF is marked in yellow.*

2. Press softkey [OK].

*The vital parameter alarm is switched off. The vital parameter field shows the symbol .*



If the alarm for a particular vital parameter has been disabled, the corpuls1 will signal no alarms for this vital parameter. In case of alarms, only the vital parameter field is highlighted.

---



When the alarm is disabled in the vital parameter context menu, the corpuls1 automatically enables the alarm in the following situations:

- The corpuls1 is configured in such a way that the respective vital parameter field is no longer displayed.
  - A pre-configured view is chosen for the corpuls1 so that the respective vital parameter field is no longer displayed.
  - Defibrillation mode ended.
- 

#### 7.4.5 Switching on a Vital Parameter Alarm

The user can enable a disabled alarm for a vital parameter.

Prerequisite:

- The vital parameter context menu is open (refer to 7.4.1 Open Vital Parameter Context Menu on page 38)

**To enable the alarm for a vital parameter, proceed as follows:**

1. Navigate to the list box *Alarm ON* by pressing the softkey [Up] or [Down].

*The list box Alarm ON is marked in yellow.*

2. Press softkey [OK].

*The vital parameter alarm is switched on. The vital parameter field shows the symbol .*

### 7.4.6 Adopting Auto Limits

To adopt the automatically calculated alarm limits (autolimits) for a vital parameter, the user has the following options: (refer to 7.4.2 Overview Vital Parameter Context Menu on page 39)

- Automatically adopting the configured alarm limits.  
If there is no signal from a vital parameter, the user can adopt the configured alarm limits (refer to 7.4.3 Changing Vital Parameter Settings on page 39).
- Adopting automatically calculated autolimits based on the current value of the vital parameter.  
If there is a signal from a vital parameter, the user can adopt the automatically calculated autolimits.

Prerequisite:

- The vital parameter context menu is open (refer to 7.4.2 Overview Vital Parameter Context Menu on page 39)

***To adopt the autolimits for a vital parameter, proceed as follows:***

1. Navigate to the list box *Autolimits* by pressing the softkey [Up] or [Down].

*The list box *Autolimits* is marked in yellow.*

2. Press softkey [OK].

*The automatically calculated or the pre-set autolimits have been adopted for a vital parameter.*

## 7.5 Curve Context Menu

In the curve context menu the user can change the settings for the curves.

### 7.5.1 Open Curve Context Menu

The user can open the the curve context menu only in monitoring mode.

***To open a curve context menu, proceed as follows:***

1. Press softkey [Signals] (refer to 7.1 Structure of the User Interface on page 33).
2. Navigate to the required curve by pressing the softkey [Up] or [Down].

*The current curve is marked in yellow.*

3. Press softkey [OK].

*The curve context menu is open.*

## 7.5.2 Overview Curve Context Menu

The following illustration gives an overview of the curve context menu.

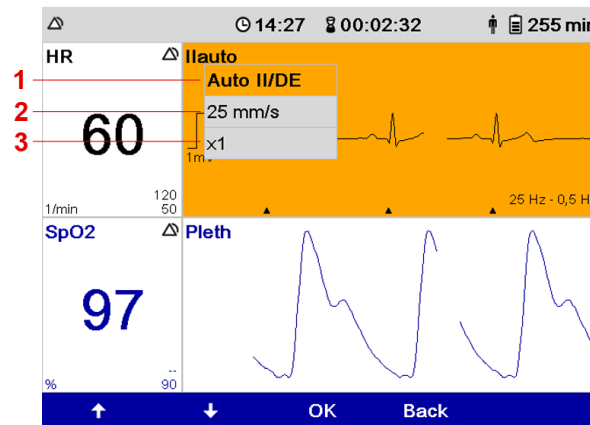

Figure 7-5 Overview Curve context menu

Item	Element	Description
1	List box <i>Curve</i>	Allows to select a different lead (refer to 7.5.3 Changing Curve Parameters on page 42) for a curve.
2	List box <i>Sweep speed</i>	Allows to select the sweep speed (refer to 7.5.4 Changing the Sweep Speed on page 43) for a curve.
3	List box <i>Curve amplitude</i>	Allows to change the amplitude (refer to 7.5.5 Changing the Curve Amplitude on page 43) of a curve.

Table 7-5 Overview Curve context menu

## 7.5.3 Changing Curve Parameters

The user can change the curve of a curve field.

Prerequisite:

- The curve context menu is open (refer to 7.5.1 Open Curve Context Menu on page 41)

**To change a curve, proceed as follows:**

- Navigate to the list box [Curves] by pressing the softkey [Up] or *Down*.  
*The list box Curves is marked in yellow.*
- Press softkey [OK].  
*The current curve is emphasised in bold font.*
- Navigate to the required curve by pressing the softkey [Up] or [Down].  
*The curve is displayed.*
- Press softkey [OK].



*The curve field shows the curve.*

#### 7.5.4 Changing the Sweep Speed

The user can change the sweep speed for a curve.

Prerequisite:

- The curve context menu is open (refer to 7.5.1 Open Curve Context Menu on page 41)

***To change the sweep speed, proceed as follows:***

1. Navigate to the list box *Sweep speed* by pressing the softkey [Up] or [Down].  
*The list box Sweep speed is marked in yellow.*
2. Press softkey [OK].  
*The current sweep speed is emphasised in bold font.*
3. Navigate to the required sweep speed by pressing the softkey [Up] or [Down].  
*The sweep speed is displayed.*
4. Press softkey [OK].

*The curve field shows the curve with the changed sweep speed.*



---

A change of the sweep speed affects all leads including the CPR curve.

---

#### 7.5.5 Changing the Curve Amplitude

The user can change the amplitude for an ECG curve.

Prerequisite:

- The curve context menu is open (refer to 7.5.1 Open Curve Context Menu on page 41)

***To change the amplitude, proceed as follows:***

1. Navigate to the list box [Amplitude] by pressing the softkey [Up] or [Down].  
*The list box Amplitude is marked in yellow.*
2. Press softkey [OK].  
*The current amplitude is emphasised in bold font.*
3. Navigate to the required amplitude by pressing the softkey [Up] or [Down].  
*The amplitude is displayed.*
4. Press softkey [OK].

*The curve field shows the curve with the changed amplitude.*



---

A change of the amplitude affects all leads.

---

### 7.6 Softkey Context Menu

The softkey context menu allows fast access to the settings of the menu.

### 7.6.1 Softkey Context Menu QRS/PT

The softkey context menu QRS/PT allows to enable and disable the QRS/PT tone and to change the volume of the QRS tone and the PT tone.

The user can enable and disable the QRS tone (refer to 13.5 Menu item ECG on page 123) and the pulse tone (refer to 13.7 Menu item Oximetry on page 126), and set the volume of the QRS/PT tone.

Changing the volume for the QRS/PT tone in the softkey context menu affects both the QRS tone and the pulse tone.



If both the QRS tone and the pulse tone are disabled, changing the volume in the softkey context menu QRS/PT implies enabling both for the current mission. If a valid ECG signal is present, the QRS tone sounds.

*To access the softkey context menu QRS/PT, proceed as follows:*

1. The following options are available:
  - a) To disable the QRS/PT tone, press the softkey [QRS/PT].

*The QRS/PT tone has been disabled.*



Figure 7-6 Softkey context menu QRS/PT (here: QRS/PT tone disabled)

- b) To change the volume of the QRS/PT tone, press softkey [QRS/PT] repeatedly until the required volume value is marked in yellow.

*The volume of the QRS/PT tone has been changed.*

### 7.6.2 Softkey Context Menu View

The softkey context menu View allows to invert the screen or to select a pre-configured view.



The user can also invert the screen (refer to 13.9.2 Submenu item Settings on page 133) or select a pre-configured view (refer to 13.4.3 Submenu item Views on page 122) in the configuration settings.

*To access the softkey context menu View, proceed as follows:*

1. The following options are available:
  - a) To invert the screen, press softkey [View] twice.

The screen is inverted.

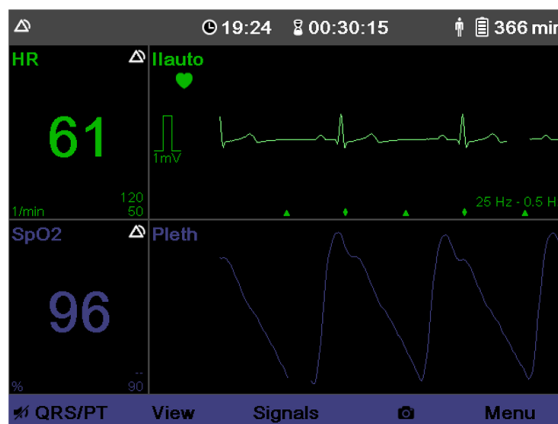

Figure 7-7 Inverted screen

- b) To select a view, press softkey [View] repeatedly until the required view is marked in yellow.

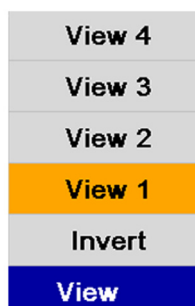

Figure 7-8 Softkey context menu view (here: View 1)

The display shows the selected view.

## 7.7 Screenshot Function

The screenshot function (assigned to the second softkey from the right) allows to save and view the current screen content as a picture file.



Created screenshots are stored in the internal memory or on the SD card (refer to 12.1 Mission Data Storage on page 110).

### 7.7.1 Creating a Screenshot

The user can create a screenshot in every operating mode.

To create a screenshot, proceed as follows:

1. Press softkey  (refer to 7.1 Structure of the User Interface on page 33).



In the other operating modes (defibrillation mode and pacemaker mode), hold down the softkey corresponding to the  icon of the monitoring mode.

The message **Screenshot successful** appears.

## 7.7.2 Showing Screenshots

The screenshot viewer allows to view created screenshots from the current mission.

To open the screenshot viewer, proceed as follows:

1. In the menu "Patient", select ► "Screenshots".

The screenshot viewer shows the most recent screenshot. The status line shows the symbol .



If the user has not yet created a screenshot, the screenshot viewer shows a big camera symbol.

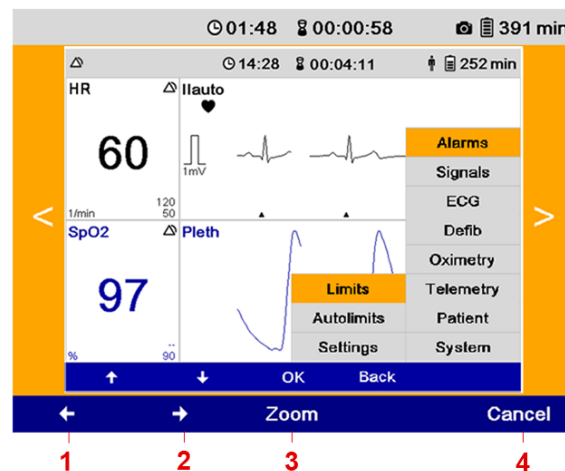



Figure 7-9 Display of Screenshot

- 1 Softkey [Left]
- 2 Softkey [Right]
- 3 Softkey Zoom
- 4 Softkey [Cancel]



To close the screenshot viewer, press softkey [Cancel].

2. The following options are available:
  - a) If the screenshot viewer shows the symbol , press softkey [Left] to view older screenshots.

*The older screenshot appears.*

- b) If the screenshot viewer shows the symbol , press softkey [Right] to view newer screenshots.

*The newer screenshot appears.*

- c) To enlarge the selected screenshot to full screen, press softkey [Zoom].

*The screenshot stays enlarged for approx. 7 s and then returns to thumbnail size.*



By pressing any softkey, the screenshot can be reduced immediately.

## 7.8 Alarm Suspension

The corpuls1 allows to suspend alarms. The alarm suspension inactivates the optical signal at the alarm light and the alarm tone.



The user can activate either the function Alarm suspension or Alarm tone silencing, depending on the settings configured by the user OPERATOR.



The alarm suspension function is only available, if the user OPERATOR has activated the function. If the function Alarm suspension is activated, the following values are available: *perm.* or 30 s, 60 s, 90 s, 120 s, 180 s (temporary alarm suspension).



If the user OPERATOR has deactivated this function (Value: *Off*) the user cannot enable or disable the alarm suspension.

### 7.8.1 Activating Alarm Suspension

The user can enable the alarm suspension. If the alarm suspension is activated, the corpuls1 will issue system alarms but no patient alarms (refer to 5.6 Alarm Design on page 23).

*To enable alarm suspension, proceed as follows:*

1. Hold down the Alarm key for two seconds (refer to 5.3 Display and Operation Elements on page 21).

*In case of permanent alarm suspension the status line shows the symbol . In case of temporary alarm suspension the status line shows the symbol  and a countdown of the remaining seconds of the temporary alarm suspension.*

*The message **Permanent alarm suspension** appears.*

### 7.8.2 Deactivating Alarm Suspension

If the alarm suspension is enabled permanently or the configured suspension time is not yet expired, the alarm suspension may be disabled by the user. After the configured period of time is expired, the alarm suspension is automatically disabled.

*To disable the alarm suspension, proceed as follows:*

1. Hold down the **Alarm** key for two seconds.

*The status line shows the symbol  $\triangle$ .*

## 7.9 Alarm Tone Silencing Function

The corpuls1 allows to silence the alarm tones of all former active alarms.



The user can activate either the function Alarm suspension or Alarm tone silencing, depending on the settings configured by the user OPERATOR.

### 7.9.1 Enabling the Alarm Tone Silencing Function

The user can enable the alarm tone silencing function. If the alarm tone silencing function has been enabled, the corpuls1 no longer signals the alarms acoustically. A new alarm disables the alarm tone silencing function.

*To enable the alarm tone silencing function, proceed as follows:*

1. Hold down the **Alarm** key for two seconds (refer to 5.6 Alarm Design on page 23).

*The corpuls1 emits a short acoustic signal to inform the user about the activation of the alarm tone silencing function.*

## 7.10 Alarm History

The alarm history lists the last six issued alarms. Alarms that have been confirmed by the user, appear at the bottom of the alarm history or disappear automatically from the alarm history.



The alarm history can contain up to 256 alarms. If the alarm history contains more than 256 alarms, the oldest alarms are overwritten.

The alarm history shows all active not-confirmed and confirmed alarms that have not automatically disappeared. The alarms are sorted from confirmed (top) to not-confirmed (bottom). The active alarms are sorted by priority and then in descending order by the time of their occurrence (last time stamp on top). Alarms are active, if the conditions that trigger the alarm are present.

### 7.10.1 Opening Alarm History

If there are alarms present, the user can open the alarm history in every operating mode.

*To open the alarm history, proceed as follows:*

1. Press **Alarm** key (refer to 5.3 Display and Operation Elements on page 21).

*The uppermost non-confirmed alarm is marked in yellow.*



If the user does not press a key or a softkey, the message disappears automatically after four seconds.

### 7.10.2 Displaying Alarm History

If the corpuls1 signals new alarms in the status line/alarm line, the corpuls1 shows these alarms first as follows:



Figure 7-10 Example: Status line/Alarm line with new alarm

This illustration shows the number of not-confirmed alarms. The colour indicates the priority of the not-confirmed alarm. The status line shows the current time or the deployment time alternating every 5 s.

The user can open the alarm history with the Alarm key:

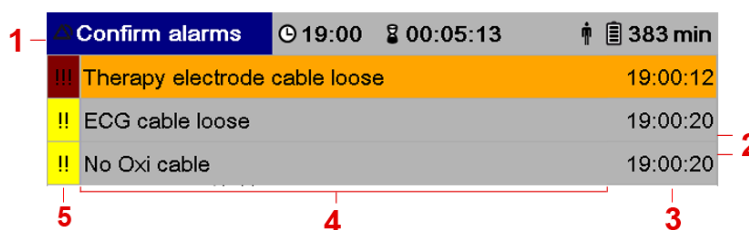

Figure 7-11 Example: Alarm history

Item	Element	Description
1	Status Line	Shows the confirmation request <b>Confirm alarms</b> highlighted in blue.
2	Alarms	Below the status line the alarm history lists not-confirmed alarms. Below that are confirmed alarms.
3	Alarm time	Indicates the time of occurrence of the alarm.
4	Alarm text	Shows the alarm text (refer to 17 Alarms and Messages on page 180). Only the topmost alarm entry is marked in yellow.
5	Alarm priority	Indicates the priority of the alarm (refer to 5.6 Alarm Design on page 23). Different colours and the number of exclamation marks signal the priority of the alarms.

Table 7-6 Overview Alarm history

### 7.10.3 Confirm Alarms

In the alarm history the user can confirm alarms.

Prerequisite:

- Alarm history is open (refer to 7.10.1 Opening Alarm History on page 48)

*To confirm an alarm, proceed as follows:*

1. Press Alarm key.

*The alarm has been confirmed and disappears from the alarm history. The next alarm is marked in yellow.*



Additionally, the parameter field is inverted. Confirmed alarms are no longer indicated by the alarm light.

---



## 8 User Interface in Defibrillation Mode

This chapter shows the user interface and instructs the user how to operate the corpuls1 in defibrillation mode. The corpuls1 allows to defibrillate a patient in automatic defibrillation mode (AED mode) (refer to 11.4.4 Overview AED Mode on page 79) and in manual defibrillation mode (refer to 11.4.7 Overview Manual Mode on page 83).

### 8.1 Structure of the User Interface

The following illustration shows the user interface in the defibrillation modes with the example of the manual mode.

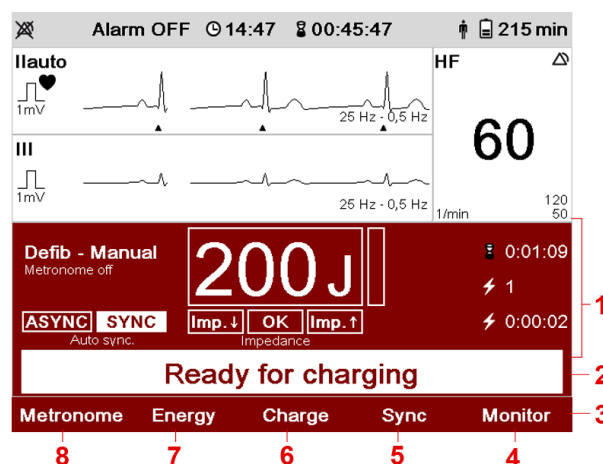

Figure 8-1 Structure of the user interface in a defibrillation mode (Example: manual mode)

Item	Element	Description
1	Defibrillator user interface	Shows available parameters of the defibrillation modes. For available parameters in AED mode (refer to 11.4.4 Overview AED Mode on page 79). For available parameters in manual mode (refer to 11.4.7 Overview Manual Mode on page 83).
2	Message line	Indicates a message.
3	Softkey line	Indicates the current assignment of the softkeys.

Item	Element	Description
4	Softkey [Monitor]	Allows to close the defibrillation mode and to return to monitoring mode (refer to 8.6 Switching to Monitoring Mode on page 56).
5	Softkey [Sync] (only in manual mode)	Allows to select the synchronisation option (refer to 8.3 Softkey Context Menu on page 53).
6	Softkey [Charge] (only in manual mode)	Allows to charge the defibrillator (refer to 8.4 Charging the Defibrillator on page 54).
7	Softkey [Energy]	Allows to select the energy for the shock (refer to 8.3.3 Softkey Context Menu Shock Energy on page 54).
8	Softkey [Metronome]	Allows to select the metronome mode (refer to 8.3.1 Softkey Context Menu Metronome on page 53).

Table 8-1 Elements of the user interface in defibrillation mode

The corpus1 allows to show two curve fields and a maximum of two vital parameter fields in the defibrillation modes.

The curve field1 is not configurable and shows the lead Auto II/DE. The curve field 2 and one vital parameter field depend on the settings configured by the user OPERATOR.

The symbols ▲, ♥, ♡, ◆ have the same meaning as in monitoring mode.



In the defibrillation modes the user cannot open or configure curve context menus or vital parameter context menus.

## 8.2 Shock Energy

The user can change the shock energy in manual mode.

*To change the shock energy in manual mode, proceed as follows:*

1. Navigate to the required energy level by pressing the softkey [Up] or [Down].
2. Press softkey [OK].  
*The energy level has been selected and is displayed in the defibrillator user interface.*
3. Alternatively, use the softkey context menu to select the energy level (refer to 8.3 Softkey Context Menu on page 53).



In AED mode the energy level can only be selected via the softkey context menu (refer to 8.3.3 Softkey Context Menu Shock Energy on page 54).

## 8.3 Softkey Context Menu

The softkey context menu in defibrillation mode allows selection of the metronome mode, the synchronisation mode or the energy level.



If the user does not press the softkeys [Metronome], [Energy] or [Sync] within three seconds or if the user presses another softkey, the softkey context menu disappears automatically and the highlighted selection is adopted.

### 8.3.1 Softkey Context Menu Metronome

The metronome of the corpuls1 supports the user acoustically during cardio-pulmonary resuscitation by means of compression- and ventilation tones. The metronome is available in AED mode and in manual mode.

*To access the softkey context menu Metronome, proceed as follows:*

1. Press the softkey [Metronome] several times, if necessary.

Child cont.
Child 15:2
Child 30:2
Adult cont.
Adult 30:2
Off
<b>Metronome</b>

Figure 8-2 Softkey Context Menu Metronome

*The metronome mode has been selected and the corpuls1 shows this mode in the defibrillator user interface.*

*The metronome is audible.*

### 8.3.2 Softkey Context Menu Synchronisation Option

The softkey context menu Sync allows to set synchronisation options for synchronised shock release in manual mode.



The softkey [Sync] is only available in manual mode.

*To access the softkey context menu Sync, proceed as follows:*

1. Press the softkey [Sync] several times, until the required value is reached.

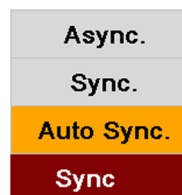

Figure 8-3 Softkey Context Menu Synchronisation

*The synchronisation option has been selected and the corpuls1 shows this option in the defibrillator user interface.*

### 8.3.3 Softkey Context Menu Shock Energy

The softkey context menu Energy allows selection of the energy level in defibrillation mode.

*To access the softkey context menu Energy, proceed as follows:*

1. In AED mode: Press softkey [Energy] once.  
In manual mode: Press softkey [Energy] twice, on different positions, respectively.
2. To configure the energy level, the following options are available:
  - a) Press the softkey [Energy] several times until the required value is reached.



Figure 8-4 Softkey context menu Energy



---

Only available in AED mode, if configured by the user OPERATOR.

---

- b) In manual mode: Press the softkey [Energy]. To configure the energy level, press softkey [Up] or [Down].
3. Press the softkey [OK] in manual mode.

*The energy level has been selected and is displayed in the defibrillator user interface.*

## 8.4 Charging the Defibrillator

In both defibrillation modes the user has to deliver the shock with the set energy level (refer to 11.4 Defibrillation and Cardioversion on page 75). In manual mode, the user first has to charge the set shock energy with the softkey [Charge].



Defibrillation with shock paddles (refer to 11.4.9 Performing Defibrillation and Cardioversion in Manual Mode with Shock Paddles on page 86).

*To charge the defibrillator in manual mode, proceed as follows:*

1. Press the softkey [Charge].

*The corpuls1 charges the set energy level. The user can see the charging progress on the white bar.*

## 8.5 corPatch CPR for assistance with thorax compressions (option)

The corPatch CPR function (option) assists the user with cardiopulmonary resuscitation providing important information on the quality of the thorax compressions. The corPatch CPR sensor used for this supplies information on the current CPR rate as well as the compression depth curve of the current thorax compressions.

The corpuls1 displays an application note, consisting of an illustration and text **Attach corPatch CPR sensor**.

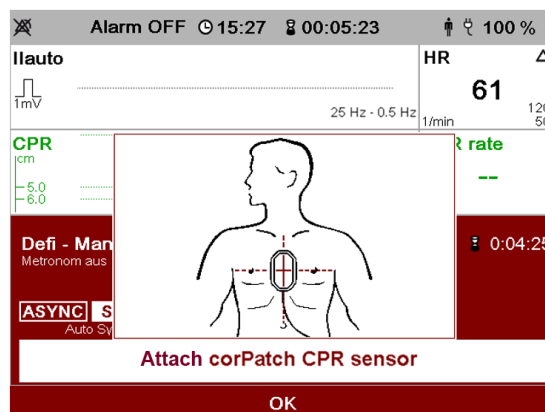

Figure 8-5 Application note corPatch CPR sensor

These application notes are issued in the following situations:

- When the corPatch CPR sensor is plugged in, but not positioned correctly and not supplying measuring values.
- In AED mode after a shock recommendation and a first completed shock or if the first analysis result is not a shock recommendation.
- In manual mode, the device reminds the user of the sensor after the first shock or three minutes after starting the manual mode.

*To close the corPatch CPR application note, proceed as follows:*

1. Press softkey [OK].

## 8.6 Switching to Monitoring Mode

The user can close the defibrillation mode and switch to monitoring mode.

*To switch to monitoring mode, proceed as follows:*

1. Press the softkey [Monitor].

*The corpuls1 is in monitoring mode.*

## 9 User Interface in Pacer Mode (Option)

This chapter shows the user interface and instructs the user how to operate the corpuls1 in optional pacer mode. The corpuls1 allows pacer therapy on the patient in the pacer modes FIX and DEMAND.

### 9.1 Structure of the User Interface

The following illustration shows the user interface in pacer mode.

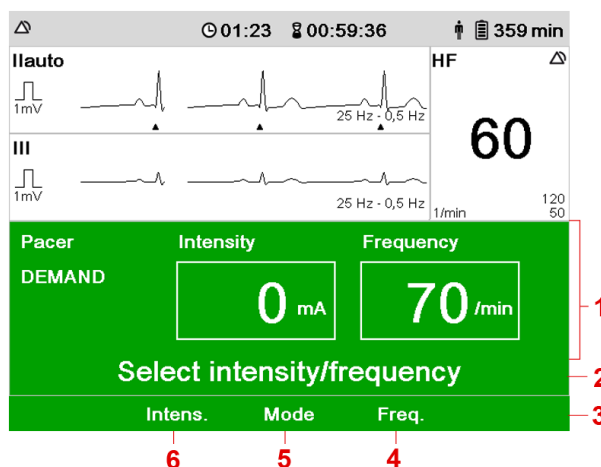

Figure 9-1 Structure of the user interface in pacer mode (Example: DEMAND mode)

Item	Element	Description
1	Pacer user interface	Shows available parameters of the pacer mode.
2	Message line	Indicates a message.
3	Softkey line	Indicates the current assignment of the softkeys.
4	Softkey [Freq.]	Allows to select the required stimulation frequency (refer to 9.5 Frequency on page 59).
5	Softkey [Mode]	Allows to select a pacer mode (FIX/DEMAND) (refer to 9.4 Pacer Mode on page 58).
6	Softkey [Intens.]	Allows to select the required stimulation intensity (refer to 9.3 Intensity on page 58).

Table 9-1 Elements of the user interface in pacer mode

The corpuls1 allows to show two curve fields and a maximum of two vital parameter fields in pacer mode.

The curve field1 is not configurable and shows the lead Auto II/DE. The curve field 2 and one vital parameter field depend on the settings configured by the user OPERATOR.

The symbols ▲, ♥, ♡, ◆ have the same meaning as in monitoring mode.



In pacer mode the user cannot open or configure curve context menus or vital parameter fields.

## 9.2 Main Menu

The user can open the main menu in every operating mode.



To be able to access the submenu item Pacer from the main menu (refer to 14.4 Menu item Pacer (Option) on page 149) the user has to call up the pacer mode.

*To open the main menu in pacer mode, proceed as follows:*

1. Hold down the key/softkey **Main menu** for three seconds (refer to 7.2.1 Opening the Main Menu on page 35).

*The main menu has been opened.*

## 9.3 Intensity

The user can configure the stimulation intensity in pacer mode.

*To set the intensity, proceed as follows:*

1. Press softkey [Intens.].
2. Press softkey [Up] or [Down] until the required value is reached.  
*The field Intensity is highlighted in white and shows the required value.*
3. To save the settings, press softkey [OK].

*The intensity has been selected and shows the current value.*

*The menu is closed. The settings will be stored until the user switches off the corpuls1. The intensity has been selected and the green field Intensity shows the current value.*



To retain the previous settings and close the menu, press the softkey [Cancel].

## 9.4 Pacer Mode

The corpuls1 has the pacer modes FIX and DEMAND.

*To select a pacer mode, proceed as follows:*

1. Press the softkey [Mode].

*The softkey line shows the pacer modes FIX and DEMAND.*



2. Press the softkey [FIX] or [DEMAND].

*The selected pacer mode is highlighted in grey and is displayed as current mode.*

3. Press softkey [OK].

*The previously selected pacer mode FIX or DEMAND is displayed as current mode.*

## 9.5 Frequency

The user can set the stimulation frequency in pacer mode.

*To set the stimulation frequency, proceed as follows:*

1. Press the softkey [Freq.].

*The softkey line shows the softkeys [Up], [Down].*

2. Press the softkey [Up] or [Down] until the required value has been reached.

*The field Frequency is highlighted in white and shows the selected value.*

3. To save the settings, press softkey [OK].

*The menu is closed. The settings will be stored until the user switches off the corpuls1.*

*The stimulation frequency has been selected and shows the current value.*



To retain the previous settings and close the menu, press the softkey [Cancel].

## 9.6 Application Note Pacer

When the user calls up the pacer mode, the application note **Recommended electrode placement** appears, consisting of an illustration and text.

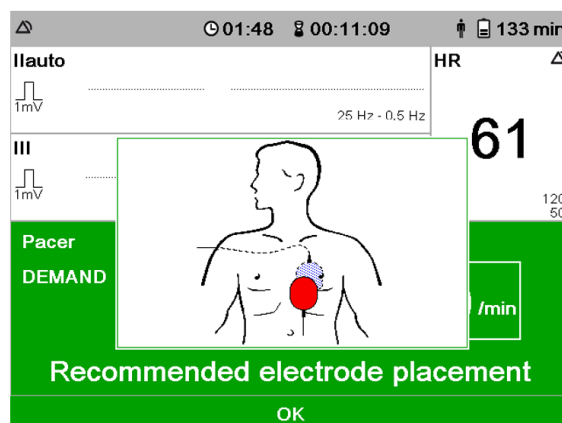

Figure 9-2 Application note Pacer

*To close the application note Pacer , proceed as follows:*

1. Press softkey [OK].

## 9.7 Switching to Monitoring Mode

The user can switch between pacer mode and monitoring mode, without having to interrupt pacer therapy.

In monitoring mode the message **STIM** is displayed in different ways, depending on the pacer status (refer to 11.5.3 Overview Pacer mode on page 92).

*To switch to monitoring mode, proceed as follows:*

1. Press the Pacer key.

*The corpuls1 is in monitoring mode.*

## 10 Operation - Monitoring

---

The corpuls1 allows to monitor the condition of critical cardiac patients over an extended period of time.

Besides ECG monitoring and optional pulse oximetry monitoring the physiological alarms of the corpuls1 alarm system (refer to 5.6 Alarm Design on page 23) pertain to the patient monitoring functions.

### 10.1 Warnings

The following warnings inform the user of possible hazards when using the corpuls1.



#### WARNING!

##### **Distorted ECG representation due to nerve stimulator, implanted pacer or soiled skin!**

Can lead to misinterpretation of the ECG and wrong diagnosis.

- ▶ When using a nerve stimulator, if an implanted pacer is present or in case of dysrhythmias, mind their influence on the representation of the ECG.
- ▶ To improve the adhesion of the electrodes, remove excessive hair from the patient's skin, clean and dry the patient's skin.
- ▶ Do not wet the electrodes with additional electrode gel.



#### WARNING!

##### **Disturbance of the heart rate indication by an implanted pacer!**

The heart rate display may be corrupted in patients with implanted pacers in that cardiac pacing pulses are detected when cardiac arrest or certain arrhythmias occur. Can lead to misinterpretation and wrong diagnosis.

- ▶ Keep pacer patients under close surveillance.
- ▶ Inform yourself in this user manual about the performance of the corpuls1.

### 10.2 Patient group

The corpuls1 allows monitoring of the patient groups adult, child and neonate.

ECG electrodes and ECG monitoring cable can be used for all patient groups.

The pulse oximetry intermediate cable can be used for all patient groups. A selection of different sensors are available for the different patient groups (e. g. finger sensor/disposable sensor/ear clip sensor adults, fingersensor/disposable sensor child, disposable sensor neonate).

## 10.3 ECG Monitoring

ECG monitoring allows a routine surveillance of the heart rhythm and the heart rate of the patient.

An ECG monitoring cable allows to obtain the following extremity leads:

- Bipolar extremity leads according to Einthoven (I, II, III).
- Unipolar extremity leads according to Goldberger (aVR, aVL, aVF).



The depolarisation wave is a spatial unit, i. e. that the beginning of one wave is not visible in all derivations at the same time. Isoelectric sections at the beginning of an QRS complex are treated as part of the following significant wave. Analogously, isoelectric segments at the end of the QRS complex are incorporated into the previous significant wave.

### 10.3.1 Colour Coding ECG Monitoring Cable

The colour coding in the illustrations of the clips of the ECG monitoring cable in the user manual refer to Code 1 (common in Europe according to IEC) and Code 2 (common in the U.S. according to AHA) of the DIN EN 60601-2-51.

Lead	CODE 1		CODE 2	
	Designation of the clip	Colour coding	Designation of the clip	Colour coding
Extremity leads according to Einthoven and Goldberger	R	Red	RA	White
	L	Yellow	LA	Black
	F	Green	LL	Red
Neutral	N	Black	RL	Green

Table 10-1 Colour coding of the clips of the ECG monitoring cable



For all representations of the ECG leads in this operating manual see CODE 1 (conventionally used in Europe according to IEC).

### 10.3.2 Starting ECG Monitoring

If the following prerequisites are met, the user can start ECG monitoring.

Prerequisite:

- The corpuls1 is switched on

*To start ECG monitoring, proceed as follows:*

1. Attach the ECG electrodes to the patient (refer to 10.7.1 ECG Monitoring Cable (Accessories) on page 69).

*ECG monitoring starts.*

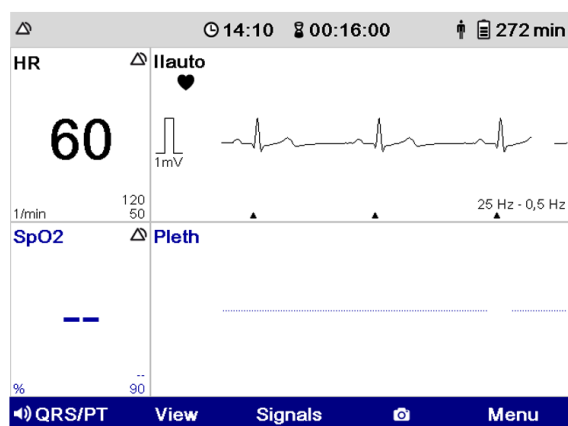

Figure 10-1 ECG monitoring (Example: monitoring mode)

The symbol ▲ in the curve field indicates a QRS marker. In the configuration dialogue of the main menu (refer to 13.5 Menu item ECG on page 123) under menu item ECG the QRS marks can be disabled.

The black flashing symbol ♥ in the curve field indicates a QRS complex. In time with the flashing symbol, the corpuls1 issues a QRS tone which can be disabled with the softkey [QRS/PT].



QRS tone and QRS marker may deviate slightly from each other.

## 10.4 Pulse Oximetry Monitoring (Option)

Pulse oximetry is a non-invasive monitoring method for continuous measurement of the peripheral arterial oxygen saturation and other vital parameters.

To increase patient safety and to be able to guarantee measurement accuracy, oximetry sensors and intermediate cables were equipped with X-CAL technology. The corpuls1 supports this function and issues alarms of different priorities to indicate that the oximetry sensor will expire soon (low priority) or that the oximetry sensor is expired (medium priority).

### 10.4.1 Warnings

The following warnings inform the user of possible hazards when using the corpuls1.



Further safety information pertaining to pulse oximetry monitoring can be found in the Appendix (refer to M Masimo Safety Information on page 252).

**WARNING!****Wrong readings due to ionising (radioactive) radiation!**

Can lead to wrong therapy of the patient.

- ▶ Do not operate the corpuls1 in the vicinity of of ionising (radioactive) radiation.
- 

**CAUTION!****Inaccurate readings due to stray light!**

Displayed readings can differ from actual readings. Bright sunlight, Xenon OP lamps or a photo-dynamic therapy with bilirubin lamps may influence the accuracy of the oximetry measurement.

- ▶ If necessary, protect the pulse oximetry sensor from straylight by using an ambient shield (refer to F Approved Accessories, Spare Parts and Consumables on page 218).
- 

**CAUTION!****Low levels of SpO<sub>2</sub> due to elevated levels of SpMet!**

At SpMet<sup>®</sup> levels of approx. 10 % - 15 % the levels of SpO<sub>2</sub> are lower. At higher levels of SpMet<sup>®</sup>, the levels of SpO<sub>2</sub> may tend to read in the low to mid-80 %.

- ▶ If elevated levels of SpMet<sup>®</sup> are suspected, a blood sample of the patient should be analysed in the laboratory.
- 

**CAUTION!****Elevated levels of SpO<sub>2</sub> due to elevated levels of SpHb!**

SpHb<sup>®</sup> values above normal tend to increase the level of SpO<sub>2</sub>. The increase of the SpO<sub>2</sub> levels corresponds approximately to the amount of SpHb that is present.

- ▶ If elevated levels of SpHb<sup>®</sup> are suspected, a blood sample of the patient should be analysed in the laboratory.
- 

**WARNING!****Wrong application of the oximetry sensor!**

Application at temperatures of more than +41 °C (+105.8 °F) and/or too high apply pressure can lead to skin lesions.

- ▶ Apply the sensor without excessive pressure, especially in patients with sensitive skin.
- 

**CAUTION!****Too long application of the oximetry sensor at a measuring point!**

If the oximetry sensor is used too long at a measurement site, reliable oximetry monitoring in the patient is not ensured.

- ▶ The maximum application time of an oximetry sensor at one measurement site is 4 h.
-

**CAUTION!****Non-approved accessories!**

Can cause inefficiency or malfunctions in the device for pulse oximetry monitoring.

- ▶ Only use accessories supplied by or approved by the manufacturer (refer to F Approved Accessories, Spare Parts and Consumables on page 218).

### 10.4.2 Pulse Oximetry Measuring Options

The availability of the extended pulse oximetry measuring options of Masimo Rainbow® SET Technology  depend on how the corpuls1 is configured and what type of pulse oximetry sensor is used. The licensing model allows service technicians to activate available pulse oximetry measuring options.



Older Masimo SET pulse oximetry sensors can only be used in combination with a special adapter cable (refer to F Approved Accessories, Spare Parts and Consumables on page 218).

The following table shows available pulse oximetry measuring options.

Pulse oximetry measuring option	Mission	Unit
SpO <sub>2</sub>	Allows to measure peripheral oxygen saturation.	%
SpCO®	Allows to measure carbon monoxide levels.	%
SpHb®	Allows to measure total haemoglobin levels.	g/dl or mmol/l, in relation to monomeric Hb levels Hb(Fe), according to IUPAC and DIN 58931.
SpMet®	Allows to measure methaemoglobin levels.	%
PR	Allows to measure the peripheral pulse rate.	1/min
PI	Allows to measure the perfusion index. By means of the perfusion index, the user can estimate the strength of the pulse. The perfusion index has a range from 0.02 % up to 20 %. The perfusion index gives information about the percentage of the pulsating blood volume.	%

Table 10-2 Pulse oximetry measuring options



The user cannot measure SpCO<sup>®</sup>- and SpHb<sup>®</sup> values at the same time. For the measurement of SpCO<sup>®</sup>- and SpHb<sup>®</sup> values different pulse oximetry sensors are necessary.

### 10.4.3 Starting Pulse Oximetry Monitoring

If the following prerequisites are met, the user can start pulse oximetry monitoring.

Prerequisite:

- The corpuls1 is switched on

*To start pulse oximetry monitoring, proceed as follows:*

1. Attach the pulse oximetry sensor to the patient (refer to 10.7.2 Pulse Oximetry Sensor (Accessories) on page 71).

*The symbol  in the vital parameter field indicates the calibration of the pulse oximeter. The readings are still unreliable.*



The calibration of the oximeter for SpCO<sup>®</sup>-, SpHb<sup>®</sup>- and SpMet<sup>®</sup> measurement can take up to 120 s.

*The symbol  disappears from the vital parameter field. Pulse oximetry monitoring starts.*

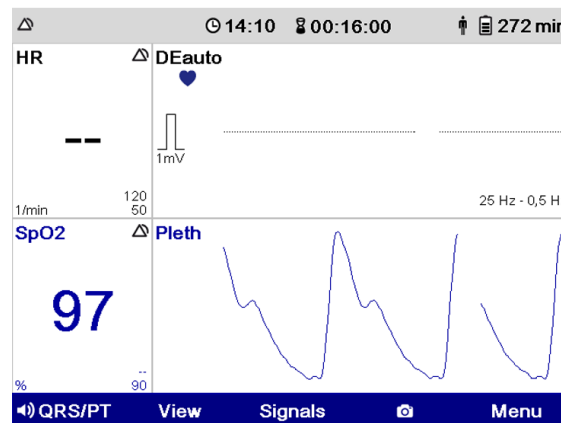



Figure 10-2 Pulse oximetry monitoring (Example: monitoring mode)

The blue flashing symbol  in the curve field indicates the heart rate measured via the pulse oximetry sensor. In time with the flashing symbol, the corpuls1 issues a pulse tone which can be disabled with the softkey [QRS/PT].



To guarantee adequate perfusion, integrity of the skin and correct alignment of the sensor, check the measuring site of the pulse oximetry sensor regularly, at least every four hours. In patients with poor perfusion, the measuring site has to be checked at least every two hours.





If the plethysmogramme shows artefacts, check the position of the pulse oximetry sensor at the measuring site and correct, if necessary.

## 10.5 Connecting Cables and Sensors to the Device

The user can connect cables and sensors for monitoring to the corpuls1.

### 10.5.1 ECG Monitoring Cable (Accessories)

The interface ECG-M allows to connect ECG electrodes.

*To connect ECG electrodes, proceed as follows:*



Figure 10-3 Connecting ECG electrodes (example without corPatch CPR sensor)

- 1 ECG-M interface
- 2 Plug of ECG monitoring cable

1. Connect (item A) the plug of the ECG monitoring cable (item 2) to the interface ECG-M (item 1).

*The message **ECG cable connected** appears.*

### 10.5.2 Pulse Oximetry Sensor (Accessories)

The oximetry interface allows to connect a pulse oximetry sensor. To connect a pulse oximetry sensor, a pulse oximetry intermediate cable is necessary.

To connect the pulse oximetry sensor with the pulse oximetry intermediate cable, proceed as follows:

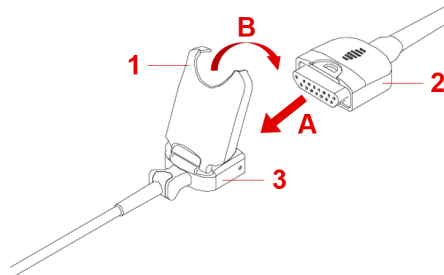

Figure 10-4 Connect the pulse oximetry sensor to the pulse oximetry intermediate cable

- 1 Clip
- 2 Plug of pulse oximetry intermediate cable
- 3 Plug of pulse oximetry sensor cable

1. Connect (item A) the plug of the pulse oximetry intermediate cable (item 2) to the plug of the pulse oximetry sensor cable (item 3).
2. Close (item B) the clip (item 1).



To separate the pulse oximetry sensor from the pulse oximetry intermediate cable, open the clip upwards and disconnect the plugs.

To connect a pulse oximetry sensor, proceed as follows:



Figure 10-5 Connecting a pulse oximetry sensor (pictured: right side of device without corPatch CPR)

- 1 Plug of pulse oximetry intermediate cable
- 2 Oximetry interface

1. Connect (item A) the plug of the pulse oximetry intermediate cable (item 1) to the Oximetry interface (item 2).

The message ***Oximetry cable connected*** appears.

*To connect a pulse oximetry sensor, proceed as follows:*

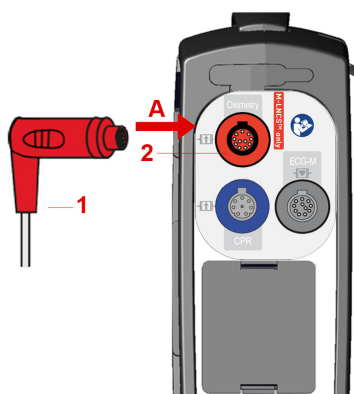

Figure 10-6 Connecting a pulse oximetry sensor (pictured: right side of device with corPatch CPR)

- 1 Plug of pulse oximetry intermediate cable
- 2 Oximetry interface

1. Connect (item A) the plug of the pulse oximetry intermediate cable (item 1) to the Oximetry interface (item 2).

*The message **Oximetry cable connected** appears.*

## 10.6 Preparing the Patient

Before the user attaches electrodes to the patient, the patient has to be prepared.

*To prepare the patient, proceed as follows:*

1. If necessary, remove excessive hair from where the electrodes will be attached.
2. If necessary, clean and dry the skin where the electrodes will be attached.

## 10.7 Attaching Electrodes and Sensors to the Patient

When the user has connected electrodes and sensors to the corpuls1, the user can attach electrodes and sensors to the patient.

### 10.7.1 ECG Monitoring Cable (Accessories)

To start ECG monitoring, the user has to attach the 4-pole ECG monitoring cable and ECG electrodes to the patient. There are two variants to attach ECG electrodes to the patient. The user has to choose variant A or variant B and connect all ECG electrodes according to the selected variant.

Prerequisites:

- The 4-pole ECG monitoring cable is connected (refer to 10.5.1 ECG Monitoring Cable (Accessories) on page 67)

- The patient is prepared (refer to 10.6 Preparing the Patient on page 69)

To attach the ECG electrodes of the 4-pole ECG monitoring cable to the patient, proceed as follows:

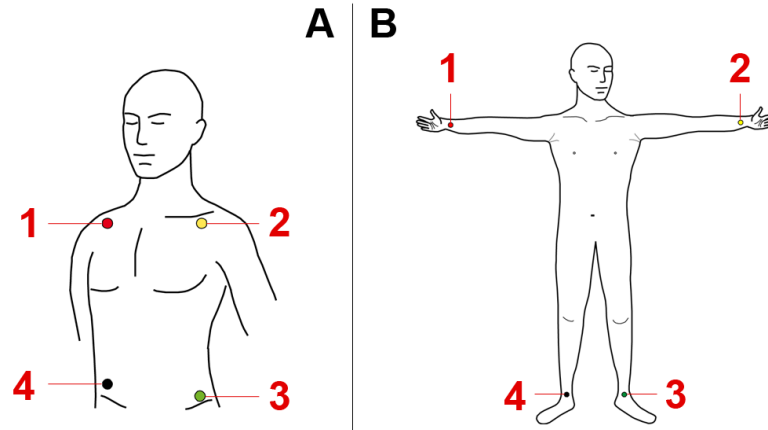

Figure 10-7 Attaching ECG electrodes to the patient

- 1 ECG electrode with red R clip
- 2 ECG electrode with yellow L clip
- 3 ECG electrode with green F clip
- 4 ECG electrode with black N clip

1. Variant A: Attach ECG electrode under the right clavicle (item 1). Attach red R clip to ECG electrode.  
Variant B: Attach ECG electrode to right arm (item 1). Attach red R clip to ECG electrode.
2. Variant A: Attach ECG electrode under the left clavicle (item 2). Attach yellow L clip to ECG electrode.  
Variant B: Attach ECG electrode to left arm (item 2). Attach yellow L clip to ECG electrode.
3. Variant A: Attach ECG electrode to the area of the left inguinal fold; central to the axis of the leg (item 3). Attach green F clip to ECG electrode.  
Variant B: Attach ECG electrode to left leg (item 3). Attach green F clip to ECG electrode.
4. Variant A: Attach ECG electrode to the area of the right inguinal fold; central to the axis of the leg (item 4). Attach black N clip to ECG electrode.  
Variant B: Attach ECG electrode to right leg (item 4). Attach black N clip to ECG electrode.

ECG monitoring starts (refer to 10.3.2 Starting ECG Monitoring on page 62).



If the black N clip is loose, the corpuls1 does not issue an alarm.



If the green F clip is loose, the corpuls1 issues, for reasons of patient safety, an alarm for the green F clip, the yellow L clip and the red R clip (refer to 17 Alarms and Messages on page 180).

### 10.7.2 Pulse Oximetry Sensor (Accessories)

To start pulse oximetry monitoring, the user has to attach a pulse oximetry sensor to the patient.

Prerequisite:

- The pulse oximetry sensor is connected (refer to 10.5.2 Pulse Oximetry Sensor (Accessories) on page 67)

***To attach the pulse oximetry sensor to the patient, proceed as follows:***

1. Attach the pulse oximetry sensor to the patient according to the instructions in the user manual of the pulse oximetry sensor.

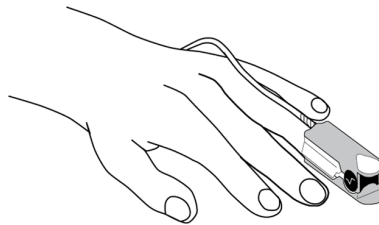

Figure 10-8 Attaching the pulse oximetry sensor (Example: finger sensor)

*Pulse oximetry monitoring starts (refer to 10.4.3 Starting Pulse Oximetry Monitoring on page 66).*

## 11 Operation – Therapy

---

The corpuls1 allows to perform therapy on the patient.

### 11.1 Warnings

The following warnings inform the user of possible hazards when using the corpuls1.



#### WARNING!

##### **Wrong placement of therapy electrodes in pacer patients!**

Can lead to irreversible damage to the myocardium in patients with implanted pacers, if the shock is conducted via the implanted pacer electrode.

- ▶ Do not place therapy electrodes directly over the pacer unit.
  - ▶ If the therapy electrodes would be near the pacer unit, choose the reversed position: below the left clavicula parasternally and below the right mamilla, approx. 5th intercostal space at the level of the apex of the heart.
- 



#### WARNING!

##### **Faulty ECG results due to shock, vibration, artificial respiration or external pacers!**

If the ECG analysis lasts too long, the results may be incorrect and may lead to misinterpretation of the ECG. This may cause diagnostic errors and as a result incorrect treatment.

- ▶ Do not touch patient during ECG analysis.
  - ▶ Avoid external commotion and vibration during ECG analysis to avoid motion artefacts.
  - ▶ Briefly discontinue artificial ventilation during ECG analysis.
  - ▶ In patients with pacers, check the vital signs.
- 



#### WARNING!

##### **Distorted ECG representation due to nerve stimulator, implanted pacer or soiled skin!**

Can lead to misinterpretation of the ECG and wrong diagnosis.

- ▶ When using a nerve stimulator, if an implanted pacer is present or in case of dysrhythmias, mind their influence on the representation of the ECG.
  - ▶ To improve the adhesion of the electrodes, remove excessive hair from the patient's skin, clean and dry the patient's skin.
  - ▶ Do not wet the electrodes with additional electrode gel.
-

**WARNING!****Wrong therapy master cable!**

Can lead to therapy failure.

- ▶ Connect the correct therapy master cable (P/N 04326.0BA).
- 

**WARNING!****Wrong net filter configuration!**

Electromagnetic fields can impair the rhythm detector and thus the analysis in AED mode, so that the shock release may not be possible.

- ▶ Have the operator check if the net filter configuration is correct.
- 

**WARNING!****Insufficient effectiveness of therapy electrodes during therapy!**

If the therapy electrodes are not fully effective, a correct defibrillator/pacer therapy on the patient may not be guaranteed or the patient may suffer serious burns.

- ▶ Follow all safety instructions on the packaging of the corPatch easy therapy electrodes.
  - ▶ Do not open pouch until ready for use.
  - ▶ If the packaging is damaged or has previously been opened, do not use the corPatch therapy electrodes.
  - ▶ Do not use corPatch therapy electrodes if the expiry date indicated on the packaging has passed.
  - ▶ Do not use the corPatch therapy electrodes if they are damaged.
  - ▶ Do not crush, bend, fold or store the corPatch therapy electrodes under heavy objects.
  - ▶ If the gel has dried, do not use the corPatch therapy electrodes.
  - ▶ Do not use additional gel on corPatch therapy electrodes.
  - ▶ Do not overlap the corPatch therapy electrodes.
  - ▶ Use separate ECG electrodes when performing non-invasive pacing.
  - ▶ Do not discharge shock paddles over corPatch therapy electrodes.
  - ▶ Keep the corPatch therapy electrodes clear of other electrodes or metal parts in contact with the patient.
  - ▶ Avoid contact between body parts of the patient, such as exposed skin on the head or limbs, with conductive fluids such as gel, blood, saline, and metal objects such as bed frames or stretchers.
-

**NOTICE!****Disruption of non-defibrillation-protected application parts of other medical devices during defibrillation!**

Other medical devices with non-defibrillation-protected application parts may be damaged by the energy delivered from corpuls1.

- ▶ Disconnect non-defibrillation-protected application parts of other medical equipment during defibrillation.

**CAUTION!****Insufficient contact of therapy electrodes during therapy mission!**

Can lead to the following side effects in patients with excessive hair or in case of incorrectly placed electrodes: Irritated skin, burn injuries as well as reddening of the patient's skin.

- ▶ Remove excessive hair from the patient's skin before therapy.
- ▶ Apply therapy electrodes to the patient according to the instructions in the user manual.
- ▶ When placing the corPatch therapy electrodes on the patient's skin, make sure that no air pockets are included inside the adhesive surface.



If the corpuls1 fails, proceed according to local resuscitation protocols.

## 11.2 Patient group

The corpuls1 allows therapy of the patient groups adult, child and neonate.

Which patient group can be treated depends on the kind of therapy electrode (refer to 11.3 Overview Therapy Electrodes on page 74).

Depending on which type of therapy electrodes is connected, the corresponding patient group is displayed in the softkey line.



Example: If shock paddles are connected, the corpuls1 displays patient classes Adult, Child and Neonate are displayed, or, if corPatch easy Pediatric electrodes are connected, patient classes Child and Neonate are displayed.

The patient group can be selected as follows:

- After connecting the therapy electrode to the device (refer to 11.8 Connecting Therapy Electrodes to the Device on page 101)
- In the main menu (refer to 13.8.2 Submenu item Patient class/-group on page 130)

## 11.3 Overview Therapy Electrodes

The following table describes the available therapy electrodes:



Therapy Electrode	Application field	Patient group
corPatch easy pre-connected Adult	Defibrillation in AED Mode	Adults from 20 kg body weight
	Defibrillation and cardioversion in manual mode	
	ECG monitoring	
	Pacer therapy	
corPatch easy Pediatric/Pediatric Extended	Defibrillation in AED Mode	Neonates and children up to 25 kg body weight
	Defibrillation and cardioversion in manual mode	
	ECG monitoring	
	Pacer therapy	
Shock paddles	Defibrillation and cardioversion in manual mode	Adults and children from 5 kg body weight
	ECG monitoring	
Shock paddles with baby shock electrodes	Defibrillation and cardioversion in manual mode	Neonates up to max. 5 kg body weight
	ECG monitoring	
Shock spoons	Defibrillation and cardioversion in manual mode	Adults and children with different shock spoon sizes A, B, C
	ECG monitoring	

Table 11-1 Overview Therapy Electrodes

## 11.4 Defibrillation and Cardioversion

For defibrillation and cardioversion of the patient, different modes are available:

- Automatic external defibrillation (AED mode)
- Manual defibrillation (manual mode)

In AED mode a therapy algorithm in the corpuls1 analyses the ECG data and triggers the charging of the defibrillator if necessary. The user can then deliver the defibrillation shock.

In manual mode the user evaluates the ECG data and delivers the defibrillation shock. For a cardioversion the user can synchronise the shock release by means of the synchronisation options Auto Sync. or Sync. The corpuls1 uses the ECG obtained via the therapy electrodes to identify the QRS complexes.

In AED mode and in manual mode, the corpuls1 signals and saves system alarms but no patient alarms (refer to 5.6 Alarm Design on page 23).

After the defibrillator is charged, the selected energy is available for 30 s. If the user does not deliver a shock within this period of time, the corpuls1 discharges the energy internally.



The use of a defibrillator in AED mode is not recommended for patients of less than twelve months of age.

If no special paediatric AED device is available for patients aged between 1 and 8 years, it is recommended to use the defibrillator in AED mode. The user can operate the corpuls1 in AED mode with corPatch easy electrodes (Pediatric/Pediatric Extended).

In AED mode and in manual mode the Auto II/DE curve is displayed in the uppermost curve field. The Auto II/DE curve alternates automatically between the DEauto lead and the IIauto lead, depending on whether the 4-pole ECG monitoring cable is connected or not. The lower curve and the vital parameters depend on the settings configured by the user OPERATOR.

The name DEauto indicates that the corpuls1 shows the ECG signal obtained via the corPatch easy electrodes, shock paddles or shock spoons. The name IIauto indicates that the corpuls1 shows the ECG signal obtained via the 4-pole ECG monitoring cable.

For a defibrillation the user has to call up the required defibrillation mode (refer to 11.4.3 Calling up AED Mode on page 78) or (refer to 11.4.6 Calling up the Manual Mode on page 82).



If configured correspondingly by the operator, a defibrillation mode can be called up automatically at startup.

### 11.4.1 Warnings



Operators can block the access to the manual defibrillation mode by means of a PIN code.



Before using the shock spoons, read and understand the additional user manual (P/N 04137).

The following warnings inform the user of possible hazards when using the corpuls1.



#### **DANGER!**

##### **Insufficient monitoring during cardioversion!**

May lead to the following side effects in the patient: Ventricular fibrillation or asystole.

- ▶ Make sure that the ECG is stable and the heart rate is at least 60 /min.
- ▶ Make sure that when *Auto sync.* is selected, the device shows continuously SYNC. Make sure that QRS marks are present in each QRS complex.
- ▶ The shock release has to be effected according to valid guidelines.



Synchronisation setting *Auto sync.*: If the corpuls1 does not recognise QRS complexes within one second, the corpuls1 releases the shock asynchronously after holding down the key **Shock** (or after pressing the buttons at the shock paddles).

**WARNING!****Electric shock when using the defibrillator!**

Can lead to the following side effects in patients, users and third parties: arrhythmias, ventricular fibrillation or asystole.

- ▶ Place the patient on a dry or non-conductive surface before defibrillation and cardioversion.
- ▶ Before defibrillation and cardioversion, remove connections from the patient, e. g. bag valve mask and O<sub>2</sub> tubes.
- ▶ Do not touch patient during defibrillation and cardioversion.
- ▶ When using shock paddles, make sure that no electrode gel gets into the insulation area between the electrode surface and the handle.

**WARNING!****Wrong selection of patient group!**

If the shock is released with a level of energy not appropriate for the patient, this can lead to the following side effects in patients (arrhythmias, ventricular fibrillation or asystole).

- ▶ Select a patient group appropriate for the patient at the corpuls1.



The user is responsible for selecting an appropriate patient group at the device (refer to 11.8.1 corPatch easy Electrodes or Shock Paddles (Accessories) on page 101) and (refer to 13.8.2 Submenu item Patient class/-group on page 130).

**NOTICE!****Effects of using the defibrillator on non-defibrillation-proof devices!**

Can lead to malfunctions or failure of non-defibrillation-proof devices.

- ▶ Disconnect non-defibrillation-proof devices (e. g. separate ECG device) from the patient before defibrillation and cardioversion.

**11.4.2 Patient Impedance**

In the following situations a high patient impedance can occur:

- Patient has excessive hair.
- Patient has soiled skin.
- Electrode surface of the shock paddles is wetted with too little electrode gel.
- Shock paddles are applied to the patient with too little pressure.
- corPatch easy electrodes are not correctly attached to the patient.

In the following situations a low patient impedance can occur:

- Electrode surface of the shock paddles is wetted with too much electrode gel.
- The therapy electrodes have been attached to the patient with too little distance between them.
- The skin of the patient is wet.

- There are technical problems with the electrode cables.

The user can monitor the patient impedance in AED mode and in manual mode.

The following illustration shows the three possible impedance indications.



Figure 11-1 Overview impedance indications

The current impedance indication is highlighted in white. If the impedance indication shows **OK** it is possible to release a shock. If the impedance shows **Imp. ↓** or **Imp. ↑** the shock release is blocked.

If shock paddles are used, there is an exception when charging the shock energy. With impedance **Imp. ↑** charging of the shock energy is possible, but no shock release.

***To improve patient impedance, proceed as follows:***

1. Remove excessive hair so that the conductive surface of the therapy electrodes has full contact with the skin.
2. Clean and dry the skin before using therapy electrodes.
3. Check the position of the therapy electrodes.
4. When using shock paddles: use either more or less electrode gel.
5. When using shock paddles: press down more.

*Patient impedance is acceptable. The user can perform defibrillation.*

### 11.4.3 Calling up AED Mode

To perform defibrillation in AED mode, the user has to call up the AED mode.

Prerequisites:

- Therapy electrodes are connected to the device (refer to 11.8 Connecting Therapy Electrodes to the Device on page 101)

***To call up the AED mode, proceed as follows:***

1. Press **Defib** key.

*When the impedance indicator shows **OK**, the message **Start analysis** appears in the message line.*

*The configuration can be set by the user OPERATOR in such a way that the **Analyse** key is additionally flashing red.*

*The AED mode is called up.*



The configuration can be set by the user OPERATOR in such a way that the device starts in monitoring mode and the manual mode can be called up by pressing the **Defib** key once. To call up the AED mode, the user has to press the **Defib** key twice.

#### 11.4.4 Overview AED Mode

- General function** In AED mode, the user is guided through a standardised resuscitation protocol. The AED mode supports the user by means of messages and audio instructions. The user can select the energy for the shock if the energy selection is not blocked by the user OPERATOR (refer to 14.3.3 Submenu item AED on page 144). The user OPERATOR can also determine the initial energy level (refer to 14.3.3 Submenu item AED on page 144). If the user is expected to press the **Analyse** key or the **Shock** key (refer to 5.3 Display and Operation Elements on page 21) these respective keys are flashing red. If these keys are flashing red or not, depends on the settings configured by the user OPERATOR.
- If the corpuls1 detects a shockable rhythm, the defibrillator starts charging. If the corpuls1 detects a non-shockable rhythm during further analysis, the corpuls1 aborts charging and discharges internally. The user has to re-start analysis. If the corpuls1 continually detects a shockable rhythm, the selected energy level is available for 30 s after charging. If the user releases no shock within this time span, the device discharges itself internally. Additionally, the ready signal is sounding.
- PreShock CPR function** The preShock CPR phase follows the analysis phase. During preShock CPR phase the corpuls1 continues the AED algorithm with the possibility to perform a specified amount of compressions before the shock is delivered. The amount of thorax compressions is configured by the user OPERATOR. When the preShock CPR function is activated, the device remains ready for shock for 30 s after a shockable rhythm is detected. During the preShock CPR phase, the metronome indicates additional compressions. The number of additional compressions is configurable at user level OPERATOR. After the defibrillator is charged at the beginning of the preShock CPR phase, the user can release the shock at any time. During this phase, the volume of the ready signal is reduced. After preShock CPR, the corpuls1 increases the volume again and the key **Shock** is flashing. After the shock is released, the metronome continues the compression tone according to the standard AED algorithm.
- Audio recording** In AED mode, a configurable audio recording option is available which is disabled by default. If the user OPERATOR activates audio recording, the corpuls1 records all surrounding noise, beginning 10 s before the start of the analysis until 10 s after the shock (refer to 14.3.2 Submenu item Settings on page 143). The volume of the audio recording is fixed. The corpuls1 stores the audio recording in the mission data.

The following illustration gives an overview of the AED mode:

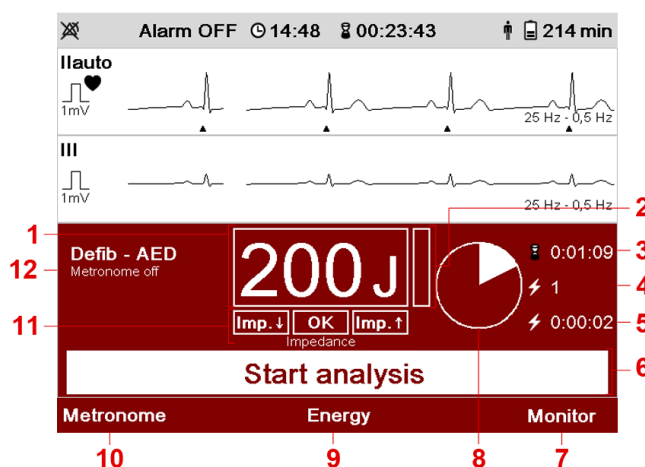

Figure 11-2 Overview AED Mode

Item	Element	Description
1	Energy	Indicates the set energy for the shock.
2	Charging status of the defibrillator	Indicates the charging status of the defibrillator. If the charging status bar is completely white, the energy for the shock is available.
3	Running time defibrillation mode	Indicates the running time in defibrillation mode in hours, minutes and seconds in the format <i>hh:mm:ss</i> . If the user switches between manual mode and AED mode, the running time continues.
4	Delivered shocks	Indicates the number of delivered shocks. If the user switches between manual mode and AED mode, the running time continues.
5	Last shock	Indicates, how much time has passed since the last shock in hours, minutes and seconds in the format <i>hh:mm:ss</i> . If the user switches between manual mode and AED mode, the running time continues.
6	Message line	Shows messages to the user.
7	Softkey [Monitor]	Allows to close the AED mode and to return to monitoring mode.
8	CPR countdown	Clock symbol with countdown: Starts at the end of the analysis phase and shows the prompt <b>Perform CPR</b> and the CPR countdown.
9	Softkey [Energy]	Allows to select the energy for the shock.

Item	Element	Description
10	Softkey [Metronome]	Allows to select the metronome mode (refer to 11.6.2 Starting the Metronome on page 97).
11	Impedance	Indicates the impedance of the patient. The current impedance is highlighted in white.
12	Metronom mode	Indicates the currently selected metronome mode.

Table 11-2 Overview AED Mode

### 11.4.5 Performing Defibrillation in AED Mode with corPatch easy Electrodes

The preShock CPR function is available in AED mode of the corpuls1. The duration of the phase before shock release can be configured at user level OPERATOR. If the user has not released a shock 30 s after charging the defibrillator, the device discharges internally.

When the following prerequisites are met, the user can start therapy.

Prerequisites:

- The therapy electrodes have been attached to the patient (refer to 11.10.1 corPatch easy Electrodes for Defibrillation and Cardioversion (Accessories) on page 105)
- AED mode is called up (refer to 11.4.4 Overview AED Mode on page 79)
- Impedance indicator is **OK** (refer to 11.4.2 Patient Impedance on page 77)

*To perform defibrillation in AED mode with corPatch easy electrodes, proceed as follows:*

1. To start the ECG analysis, press the **Analyse** key.



If the energy selection has been enabled at user level OPERATOR, the softkey [Energy] is visible. To configure the energy level, press softkey [Energy] repeatedly until the required energy level is marked in yellow and confirm with softkey [OK].



If the corpuls1 detects a shockable rhythm, the defibrillator starts charging. If the corpuls1 detects a non-shockable rhythm during further analysis, the defibrillator aborts charging and discharges internally. The user has to re-start analysis.

*The ECG analysis starts.*

2. One of the following situations occurs:

- a) The message **Deliver shock** appears and the ready signal sounds.

The configuration can be set by the user OPERATOR in such a way that the **Shock** key is additionally flashing red.

To deliver a shock, hold down the **Shock** key until the shock has been delivered.

*The message **Shock performed** appears.*

- b) The message **Shock not recommended** appears.

*It is not possible to release a shock.*

*The message **Perform CPR** appears.*

*The corpuls1 shows the running CPR countdown.*

3. Continue to perform the standardised or locally valid resuscitation protocol until the configured compressions are done.
4. The message **Start analysis** appears.  
Repeat the instruction from step 1.

*Defibrillation has been performed.*

#### preShock CPR phase

Prerequisites:

- The preShock CPR function is enabled.
- The ECG analysis has yielded “Shock recommended”.

*To perform defibrillation in AED mode with corPatch easy electrodes and enabled preShock CPR function, proceed as follows:*

1. Perform CPR and follow the cues of the corpuls1.

*Ready-signal decreases volume.*

*The message **Perform preShock CPR** appears.*

*The **Shock** key is not flashing.*

2. Perform the additional preShock CPR compressions.

*The preShock CPR function indicates the compressions to be performed.*



---

When the user releases a shock during preShock CPR, the AED algorithm starts anew.

---

*If the configured preShock CPR compressions have been signalled, the message **Deliver shock** appears in the message line and the **Shock** key flashes red.*

3. To deliver a shock, hold down the **Shock** key until the shock has been delivered.

*The message **Shock performed** appears.*

4. Continue to perform the standardised or locally valid resuscitation protocol.

5. The message **Start analysis** appears.

Repeat the instruction from step 1.

*Defibrillation has been performed.*

### 11.4.6 Calling up the Manual Mode

To perform defibrillation or cardioversion in manual mode, the user has to call up the manual mode.

Prerequisites:

- Therapy electrodes are connected to the device (refer to 11.8 Connecting Therapy Electrodes to the Device on page 101)

*To call up the manual mode, proceed as follows:*

1. Press twice the **Defib** key.



---

If the access control for the manual mode is enabled, the user has to enter the access code for manual mode **MAN. DEFIB.**

---



The message **Manual defibrillation mode?** appears.

2. Press softkey [OK].

When the impedance indicator shows **OK**, the message **Ready for charging** appears in the message line.



To abort the process, press softkey [Cancel].

The manual mode is called up.



The configuration can be set by the user OPERATOR in such a way that the device starts in monitoring mode and the manual mode can be called up by pressing the **Defib** key once.

In this case, the message **Manual defibrillation mode?** does not appear.



The configuration can be set by the user OPERATOR in such a way that the device already starts in AED mode. To call up the manual mode, press the **Defib** key once and confirm the message **Manual defibrillation mode?** by pressing the softkey [OK].

### 11.4.7 Overview Manual Mode

The manual mode allows the users full freedom of action and decision-making concerning the operation of the defibrillator. The users have to assess the ECG on their own authority and can select the energy for the defibrillation shock on their own responsibility. When the user has charged the shock energy, the device is ready to shock.

The configuration can be set by the user OPERATOR in such a way that the corpuls1 indicates readiness to shock additionally with the ready signal and/or the **Shock** (refer to 5.3 Display and Operation Elements on page 21) key flashing red.

The following illustration gives an overview of the manual mode:

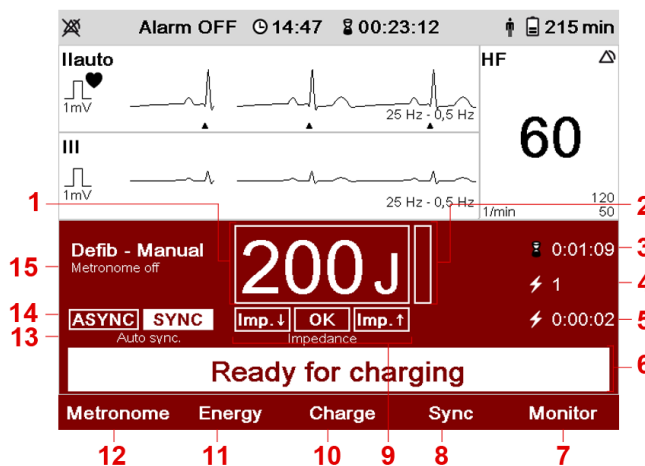

Figure 11-3 Overview Manual Mode

Item	Element	Description
1	Energy	Indicates the set energy for the shock.
2	Charging status of the defibrillator	Indicates the charging status of the defibrillator. If the charging status bar is completely white, the energy for the shock is available.
3	Running time defibrillation mode	Indicates the running time in defibrillation mode in hours, minutes and seconds in the format <i>hh:mm:ss</i> . If the user switches between manual mode and AED mode, the running time continues.
4	Delivered shocks	Indicates the number of delivered shocks. If the user switches between manual mode and AED mode, the running time continues.
5	Last shock	Indicates, how much time has passed since the last shock in hours, minutes and seconds in the format <i>hh:mm:ss</i> . If the user switches between manual mode and AED mode, the running time continues.
6	Message line	Shows messages to the user.
7	Softkey [Monitor]	Allows to close the manual mode and to return to monitoring mode.
8	Softkey [Sync]	Allows to select the synchronisation options <i>Auto Sync.</i> , <i>Sync.</i> and <i>Async.</i>
9	Impedance	Indicates the impedance of the patient. The current impedance is highlighted in white.
10	Softkey [Charge]	Allows to charge the defibrillator.
11	Softkey [Energy]	Allows to select the energy for the shock.
12	Softkey [Metronome]	Allows to select the metronome mode.
13	<i>Auto Sync.</i> Synchronisation status	Indicates the currently selected synchronisation option <i>Auto Sync.</i>
14	Synchronisation option	Indicates the currently selected synchronisation option ( <i>SYNC/ASYNC</i> ).
15	Metronome mode	Indicates the currently selected metronome mode.

Table 11-3 Overview Manual Mode

The following synchronisation options are available:

- *Auto Sync.*  
If QRS complexes are detected, the corpuls1 synchronises the shock release automatically for a cardioversion. If the corpuls1 does not detect QRS complexes within one second, the shock is released asynchronously.

- *Sync.*  
If QRS complexes are detected, the corpuls1 synchronises the shock release for a cardioversion. If no QRS complexes are detected, a shock release is not possible.
- *Async.*  
The corpuls1 performs only asynchronous defibrillation. A cardioversion is not possible.  
If the field *SYNC* is highlighted white and there are QRS complexes detected, the corpuls1 synchronises the shock release for a cardioversion. If the field *ASYNC* is highlighted white, the corpuls1 performs asynchronous defibrillation.

### 11.4.8 Performing Defibrillation and Cardioversion in Manual Mode with corPatch easy Electrodes

When the following prerequisites are met, the user can start therapy.

Prerequisite:

- The therapy electrodes have been attached to the patient (refer to 11.10.1 corPatch easy Electrodes for Defibrillation and Cardioversion (Accessories) on page 105)
- Manual mode is called up (refer to 11.4.6 Calling up the Manual Mode on page 82)
- Impedance indicator is OK (refer to 11.4.2 Patient Impedance on page 77)

***To perform defibrillation and cardioversion in manual mode with corPatch easy electrodes, proceed as follows:***

1. To configure the energy level, the following options are available:
  - a) Press softkey [Energy]. Press softkey [Energy] repeatedly until the required energy level is marked in yellow. Confirm the energy level by pressing the softkey [OK].
  - b) Press softkey [Energy]. To configure the energy level, press softkey [Up] or [Down]. Confirm the energy level by pressing the softkey [OK].

*The energy level has been set.*

2. To configure synchronisation settings, press softkey [Sync].



After calling up the manual mode, the synchronisation setting *Sync = Auto Sync.* is automatically enabled.

*When the synchronisation setting Sync is selected, the synchronisation setting Auto Sync. is enabled.*

*When selecting the synchronisation setting Sync = Sync. the synchronisation type SYNC appears.*

*When selecting the synchronisation setting Sync = Async. the synchronisation type ASYNC appears.*



Relevant with cardioversion: with the synchronisation setting *Sync = Auto Sync.* make sure that this synchronisation type *SYNC* appears continuously and that the QRS marks appear with each QRS complex.

If there is no QRS complex for some time, the synchronisation type *ASYNC* appears.



If the user wants to initiate cardioversion on QRS complexes that are always present, the synchronization setting is *Sync = Sync.* to choose.

3. To start the charging process of the defibrillator, press softkey [Charge].

*The message **Charging** appears in the message line.*

*The message **Deliver shock** appears.*

*The configuration can be set by the user OPERATOR in such a way that the corpuls1 indicates readiness to shock additionally with the ready signal and/or the **Shock** key flashing red.*



To abort the process, press softkey [Cancel].

4. To deliver a shock, hold down the **Shock** key until the shock has been delivered.

*The message **Shock performed** appears.*

5. Continue to perform the standardised or locally valid resuscitation protocol.
6. If necessary, release more asynchronous or synchronous shocks (steps 3 to 5)

*Defibrillation or cardioversion has been performed.*

#### 11.4.9 Performing Defibrillation and Cardioversion in Manual Mode with Shock Paddles

When the following prerequisites are met, the user can start therapy.



To improve the signal quality, the user can attach the ECG electrodes of the 4-pole ECG monitoring cable to the patient (refer to 10.5.1 ECG Monitoring Cable (Accessories) on page 67). The corpuls1 obtains then the ECG via the ECG electrodes (refer to 10.3 ECG Monitoring on page 62).

Prerequisite:

- Manual mode is called up (refer to 11.4.6 Calling up the Manual Mode on page 82)

*To perform defibrillation and cardioversion in manual mode with shock paddles, proceed as follows:*

1. To configure the energy level, the following options are available:
  - a) Hold both shock paddles with the electrode surfaces against each other (short circuit). To decrease the energy, briefly press the green **APEX** shock paddle button. To increase the energy, briefly press the red **STERNUM** shock paddle button.
  - b) Press softkey [Energy]. Press softkey [Energy] repeatedly until the required energy level is marked in yellow. Confirm the energy level by pressing the softkey [OK].
  - c) Press softkey [Energy]. To configure the energy level, press softkey [Up] or [Down]. Confirm the energy level by pressing the softkey [OK].

*The energy level has been set.*

2. To set the synchronization, press the [Sync] soft key and proceed as described for corPatch easy electrodes in manual mode (refer to 11.4.8 Performing Defibrillation and Cardioversion in Manual Mode with corPatch easy Electrodes on page 85).
3. To start the charging process of the defibrillator, the following options are available:
  - a) Press the green **APEX** shock paddle button.
  - b) Press the red **STERNUM** shock paddle button.

*The message **Charging** appears in the message line.*

*The message **Deliver shock** appears.*

*The configuration can be set by the user OPERATOR in such a way that the corpuls1 indicates readiness to shock additionally with the ready signal and/or the **Shock** key flashing red.*



To abort the process, press softkey [Cancel]. The shock-resistant defibrillator can also be discharged internally by pressing the two **APEX** and **STERNUM** shock-paddle buttons simultaneously.

If the user aborts with the shock paddle buttons, the message **Shock aborted** appears. If the user was unable to start the loading process, no softkey [Cancel] appears.

---



If an **APEX** / **STERNUM** shock paddle button has an undefined state, the message **Press shock paddle buttons again** appears in the message line.

---

4. Position the shock paddles onto the thorax of the patient (refer to 11.10.3 Shock Paddles for Defibrillation and Cardioversion (Accessories) on page 107).



When using synchronous defibrillation with shock paddles without the 4-pin ECG monitoring cable, ECG artifacts can be created when placed, which can make synchronization more difficult. In this case, the user must pay particular attention to a good contact and regular QRS detection.

---

5. To deliver a shock, hold down both the green **APEX** and the red **STERNUM** shock paddle buttons simultaneously until the shock has been delivered.
 

*The message **Shock performed** appears.*
6. Continue to perform the standardised or locally valid resuscitation protocol.

#### 11.4.10 Performing Defibrillation and Cardioversion on Children and Neonates in Manual Mode with Baby Shock Electrodes

In order to use the baby shock electrodes (adapters), the user has to connect the baby shock electrodes with the shock paddles.



If baby shock electrodes are used and the patient group Neonate is selected, the device automatically reduces the energy to 10 % of the selected value, i. e. up to max. 20 J.

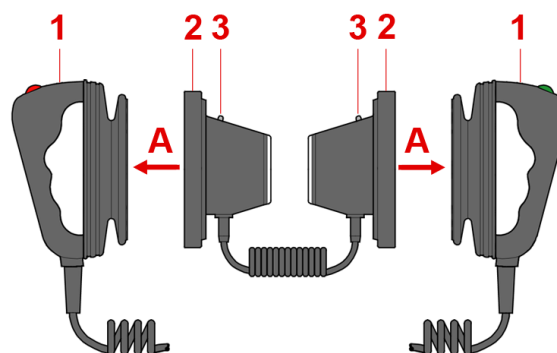

Figure 11-4 Preparing shock paddles with baby shock electrodes

- 1 Shock paddles (for adults)
- 2 Baby shock electrodes
- 3 Diode

**Prerequisite:**

- Shock paddles are connected (refer to 11.8.1 corPatch easy Electrodes or Shock Paddles (Accessories) on page 101)

**To prepare the shock paddles for use with baby shock electrodes (adapters) (including functional test), proceed as follows:**

1. Press (item A) the baby shock electrodes (item 2) onto the shock paddles (item 1).  
*The curved edge engages perceptibly.*
2. Select an energy level of e. g. 100 J, so that an energy level 10 J can be released via the baby shock electrodes. To select the energy level, the following options are available:
  - a) Press softkey [Energy] repeatedly until the required energy level is marked in yellow. Confirm with the softkey [OK].
  - b) Press softkey [Energy]. To select the energy level, press softkey [Up] or [Down]. Confirm with the softkey [OK].*The energy level has been set.*
3. Functional test:  
Hold baby shock electrodes together with the electrode surfaces touching (short circuit), then start the charging process by pressing the green shock paddle button APEX or the red button STERNUM. After charging, press both shock paddle buttons APEX and STERNUM simultaneously to release the shock.
4. One of the following situations occurs:
  - a) Both diodes (item 3) light up.  
*The shock counter registers a released shock.*  
*The shock paddles with baby shock electrodes are ready to use.*
  - b) Both diodes (item 3) do not light up.

*Check the connections and repeat the instruction from step 3.*

The user can perform defibrillation and cardioversion on children and neonates in manual mode. Perform defibrillation as described for shock paddles in manual mode (refer to 11.4.9 Performing Defibrillation and Cardioversion in Manual Mode with Shock Paddles on page 86).

### 11.4.11 Performing Defibrillation and Cardioversion in Manual Mode with Shock Spoons



#### CAUTION!

#### Wrong handling due to failure to read the user manual!

Can lead to endangerment of users, patients and third parties.

- ▶ Read and follow the shock spoon user manual (P/N: 04137).

The shock spoons for internal defibrillation consist of the shock spoon electrodes, the shock spoon handles and the pertaining Y-adapter cable. Before use the shock spoon electrodes have to be screwed onto the handles. The shock spoon holders have to be connected with the pertaining Y-adapter. The user has to connect the plug at the shock spoon adapter cable to the therapy socket of the corpuls1.



If the user connects the shock spoons to the corpuls1, the energy is limited automatically to 50 J.



To improve the signal quality, the user can attach the ECG electrodes of the 4-pole ECG monitoring cable to the patient (refer to 10.5.1 ECG Monitoring Cable (Accessories) on page 67). The corpuls1 obtains then the ECG via the ECG electrodes (refer to 10.3 ECG Monitoring on page 62).

The manufacturer recommends to obtain the ECG via the ECG monitoring cable (refer to 10.3 ECG Monitoring on page 62).

When the following prerequisites are met, the user can start therapy.

Prerequisite:

- Shock spoons are connected (refer to 11.8.3 Shock Spoons (Accessories) on page 104)
- A second user handles the shock spoons
- Manual mode is called up (refer to 11.4.6 Calling up the Manual Mode on page 82)

***To perform defibrillation and cardioversion in manual mode with shock spoons, proceed as follows:***

1. To configure the energy level, the following options are available:
  - a) Press softkey [Energy]. To configure the energy level, press softkey [Up] or [Down]. Confirm the energy level by pressing the softkey [OK].
  - b) Press softkey [Energy]. Press softkey [Energy] repeatedly until the required energy level is marked in yellow. Confirm the energy level by pressing the softkey [OK].

*The energy level has been set.*

*The message **Ready for charging** appears.*



To abort the process, press softkey [Cancel].

2. To configure synchronisation settings, press softkey [Sync] and proceed as described in manual mode with corPatch easy electrodes (refer to 11.4.8 Performing Defibrillation and Cardioversion in Manual Mode with corPatch easy Electrodes on page 85).
3. To start the charging process of the defibrillator, press softkey [Charge]. To start the charging process of the defibrillator, press softkey Charge.

*The message **Deliver shock** appears.*

*The configuration can be set by the user OPERATOR in such a way that the corpuls1 indicates readiness to shock additionally with the ready signal and/or the **Shock** key flashing red.*

4. Press the shock spoons to the heart of the patient.

*The shock spoons are pressed to the heart of the patient.*

5. To deliver a shock, hold down the **Shock** key until the shock has been delivered.

*The message **Shock performed** appears.*



To abort the process, press softkey [Cancel].

6. Continue to perform the standardised or locally valid resuscitation protocol.

*Defibrillation or cardioversion has been performed.*

## 11.5 Pacer (Option)

The external pacer of the corpuls1 allows electrical stimulation of the heart muscle. The electrical stimulation can supplement or positively influence the function of the heart muscle.

The pacer emits pacing pulses via the corPatch easy electrodes.

In FIX operating mode, the pacer stimulates the heart muscle with the set stimulation frequency regardless of the patient's own heart rate.

In DEMAND mode the corpuls1 analyses the ECG via the 4-pole ECG monitoring cable. In DEMAND mode, the pacer only stimulates when the patient's heart rate, obtained via the 4-pole ECG monitoring cable, differs from the pre-set pacing frequency. The automatic recognition of QRS complexes prevents pacing during the vulnerable phase of the heart.



To detect the patient's own heart rate in DEMAND mode, the 4-pole ECG monitoring cable is necessary.

When the user has set the parameters *Frequency* and *Intensity*, the corpuls1 emits pacing impulses in the pacer modes (DEMAND/FIX).



The patient must not remain unattended when using the external pacer.





---

Regularly check effectiveness of the pacer by checking the central pulse.

---

In pacer mode, the topmost curve is the IIaUTO lead. In pacer mode, the lower curve and the vital parameters depend on the settings configured by the user OPERATOR.

### 11.5.1 Warnings

The following warnings inform the user of possible hazards when using the corpuls1.



#### WARNING!

##### Wrong configuration of pacer mode!

If the DEMAND mode is indicated and the FIX mode is used instead, this may cause the release of pacer pulses in the vulnerable phase. This can lead to arrhythmias, ventricular fibrillation or asystole.

- ▶ Make sure to use the FIX mode only when indicated.
- 



#### WARNING!

##### Patients with an implanted pacer!

In patients with an implanted pacer, it is possible that shockable ECG rhythms or arrhythmias will only be detected to a limited extent.

- ▶ The user has to assess the ECG rhythms or arrhythmias correctly, based on experience.
- 



#### CAUTION!

##### Attaching or removing ECG electrodes during ECG monitoring in DEMAND mode!

If this occurs, the corpuls1 briefly displays false-positive pacer pulses, although the patient does not have an implanted pacer.

- ▶ Attach the ECG electrodes before calling up the pacer in DEMAND mode.
- 

### 11.5.2 Calling up the Pacer Mode

To be able to perform pacer therapy the user has to call up the pacer mode.

Prerequisite:

- The corpuls1 is switched on
- The therapy electrodes have been attached to the patient (refer to 11.10.2 corPatch easy Electrodes for Pacer Therapy (Accessories) on page 106)
- To use the pacer mode DEMAND, the 4-pole ECG monitoring cable must be connected to the corpuls1

*To call up the pacer mode, proceed as follows:*

1. Press the **Pacer** key.

*The pacer mode DEMAND is called up, but not yet active (refer to 9.1 Structure of the User*

*Interface on page 57).*

*The message **Select intensity/frequency** appears.*

*After calling up the pacer mode, the monitoring mode stays active in the background. If one of the defibrillation modes was active, the corpuls1 automatically closes this mode when the pacer mode is called up.*



Performing pacer therapy is only possible, if corPatch electrodes are connected to the corpuls1. If the user removes the corPatch electrode cable during pacer therapy, the pacer stops automatically. The corpuls1 pacer no longer emits pacer pulses and the message **Connect pacer cable** appears. If the user re-connects the corPatch electrode cable, the pacer resumes emitting pacer pulses.



Performing pacer therapy in DEMAND mode is only possible, if the 4-pole ECG monitoring cable is connected.

If the user removes the 4-pole ECG monitoring cable during pacer therapy, the pacer stops automatically and the message **Switch pacer to FIX mode?** and a confirmation prompt appears. If the user re-connects the 4-pole ECG monitoring cable within 10 s, the pacer resumes stimulation.



The user can switch between pacer mode and monitoring mode, without having to interrupt pacer therapy.

If the user switches from monitoring mode to defibrillation mode while the pacer is active, the message **Switch off pacer?** appears. The user has to confirm with the softkey [OK] to switch to defibrillation mode.

### 11.5.3 Overview Pacer mode

The message **STIM** in curve field1 bottom left indicates the following status:

Status of "STIM" message	Description
<b>STIM</b> permanent	Pacer mode is called up, but not stimulating, e. g. in DEMAND mode when stimulation is not necessary.
<b>STIM</b> flashing	The pacer is stimulating.
<b>STIM</b> not displayed	The pacer is switched off or pauses.

Table 11-4 Status of **STIM** message

The following illustration gives an overview of the pacer mode.

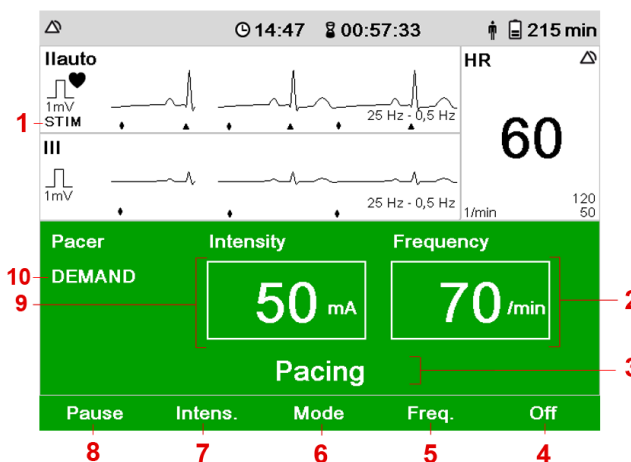

Figure 11-5 Overview Pacer mode

Item	Element	Description
1	STIM	Indicates a pacer pulse. Is displayed permanently or flashes according to the frequency of stimulation.
2	Frequency	Indicates the configured pacing frequency.
3	Message line	Shows messages to the user.
4	Softkey [Off]	Allows to end pacing.
5	Softkey [Freq.]	Allows to set the stimulation frequency.
6	Softkey [Mode]	Allows to switch the pacer mode.
7	Softkey [Intens.]	Allows to set the intensity of the pacer pulse.
8	Softkey [Pause]	Allows to pause pacing.
9	Intensity	Indicates the configured intensity of the pacer pulse in mA.
10	Pacer mode (DEMAND/FIX)	Indicates the currently selected pacer mode (DEMAND/FIX).

Table 11-5 Overview Pacer mode

### 11.5.4 Performing Pacer Therapy

**DEMAND mode** The pacer always starts in DEMAND operating mode, with the intensity at 0 mA and pacing frequency at 70 /min.



Pacing begins automatically as soon as an intensity of more than 0 mA is selected and the stimulation frequency is higher than the heart rate.



The corpuls1 immediately adjusts the pacing frequency and -intensity, when the user changes those parameters.

When the following prerequisites are met, the user can start therapy.

Prerequisites:

- Pacer mode DEMAND is called up
- The therapy electrodes have been attached to the patient (refer to 11.10.2 corPatch easy Electrodes for Pacer Therapy (Accessories) on page 106)
- To use the pacer mode DEMAND, the 4-pole ECG monitoring cable must be connected to the corpuls1

*To to perform pacer therapy with corPatch easy electrodes, proceed as follows:*

1. DEMAND mode: Check if the ECG signal is stable.

*The message **Select intensity/frequency** appears.*



If the operating mode FIX is indicated, press softkey [Mode].

The message **Select mode** appears.

Press softkey [FIX].

The pacer switches from DEMAND mode to FIX mode.

2. To select the pacing frequency, press softkey [Freq.].

*The field "Frequency" is highlighted in white.*

*The message **Select frequency** appears.*

3. To configure the pacing frequency, press softkey [Up] or [Down].

4. Confirm with the softkey [OK].

*The pacing frequency has been selected.*



To abort the process, press softkey [Cancel].

5. To select the pacing intensity, press softkey [Intens.].

*The field "Intensity" is highlighted in white.*

*The message **Select intensity** appears.*

6. To configure the intensity, press softkey [Up] or [Down].

7. Confirm with the softkey [OK].

*The pacing intensity has been selected.*

*The message **Pacing** appears.*

*The pacer is stimulating. The message **STIM** is displayed in curve field 1 bottom left, flashing or permanent.*



To abort the process, press softkey [Cancel].

**No ECG signal in DEMAND mode**

If there is no ECG signal in DEMAND mode, the confirmation request **Switch pacer to FIX mode?** appears in the message line. This confirmation request offers the option to switch to FIX mode or to terminate pacemaker therapy. This is the case if, e. g. the ECG monitoring cable is removed. Simultaneously the alarm message "No ECG cable (DEMAND)" appears in the status line. If the user chooses no option, the confirmation prompt closes automatically after 10 s and the pacemaker stops and the message **No ECG cable (DEMAND)** appears in the message line.

The confirmation request also appears, if the corpuls1 is in monitoring mode with the pacemaker running. If the user does not respond, the confirmation request closes automatically after 10 s and the corpuls1 switches the pacemaker off. The message **No ECG cable (DEMAND)** is displayed in the message line.

**To continue pacing, proceed as follows:**

1. To switch to FIX mode press softkey [Yes].

*The corpuls1 continues pacing in FIX mode.*

2. To stop pacing press softkey [No].

*Pacemaker is off.*

*The message **No ECG cable (DEMAND)** appears.*

**Switching to Monitoring Mode**

The user can switch to monitoring mode while pacemaker therapy is carried out in the background.

**To switch to monitoring mode, proceed as follows:**

1. Press the **Pacer** key.

*The user interface switches from pacemaker mode to monitoring mode.*

**11.5.5 Pausing the Pacer Mode**

If the corpuls1 operates in pacemaker mode, the user can pause the pacemaker.

Prerequisite:

- One of the pacemaker modes FIX or DEMAND is active

**To pause the pacemaker, proceed as follows:**

1. Press softkey [Pause].

*The confirmation prompt **Pause pacing?** appears.*

2. Confirm with the softkey [Yes].

*The message **Pause** appears.*



If the user does not want to pause the pacemaker and presses the softkey [No], the message **Pacing** appears. The corpuls1 continues pacemaker therapy.

3. To continue pacemaker therapy after the message **Pause**, press softkey [Cont. pacing].

*The message **Continue pacing?** appears.*

4. Confirm with the softkey [Yes].

*The message **Pacing** appears.*

*The pacemaker is stimulating. The message **STIM** is displayed in curve field 1 bottom left,*

*flashing or permanent.*



---

If the user presses the softkey [No], the message *Pause* appears.

---

### 11.5.6 Exiting the Pacer Mode

If the corpuls1 is in pacer mode, the user can exit the pacer mode.

Prerequisite:

- One of the pacer modes FIX or DEMAND is active

*To exit the pacer mode, proceed as follows:*

1. To stop pacing, press the softkey [Off].  
*The message **Switch off pacer?** appears.*
2. Confirm with the softkey [Yes].



---

If the user presses the [No] softkey, the corpuls1 continues stimulation.

---

*The pacer is switched off.*

## 11.6 Metronome for Assistance with Thorax Compressions

The metronome of the corpuls1 supports the user acoustically during cardio-pulmonary resuscitation by means of compression- and ventilation tones. The metronome is available in AED mode and in manual mode.

The compression tone signals to the user in what rhythm to perform thorax compressions. To signal the upcoming ventilation phase, the five last compression tones are higher pitched. The ventilation tones indicate when the user needs to ventilate the patient. The metronome issues tones for inspiration and tones for expiration. The metronome switches automatically between compression tones and ventilation tones.

If the user activates the metronome while the QRS tone is active, the QRS tone is muted automatically.

The metronome stays switched on in the following situations:

- If the user switches between manual mode and AED mode while the metronome is active.
- If the user switches to monitoring mode.

The metronome pauses automatically and later continues in the following situations:

- When the device is ready to shock in manual mode.
- After the shock has been released or 10 seconds after readiness to shock without releasing a shock, the metronome resumes signalling the compression tone.

During the ECG analysis in AED mode.

### 11.6.1 Overview Metronome Settings

The following table shows the available metronome modes:

Setting	Description
Child continuous	The metronome issues continuously compression tones.
Child 15:2	15 compression tones followed by 2 ventilation tones.
Child 30:2	30 compression tones followed by 2 ventilation tones.
Adult continuous	The metronome issues continuously compression tones.
Adult 30:2	30 compression tones followed by 2 ventilation tones.
off	The metronome is switched off.

Table 11-6 Overview Metronome Settings

### 11.6.2 Starting the Metronome

The metronome starts automatically in AED or manual mode, if so configured at user level OPERATOR.

If the following prerequisites are met, the user can start the metronome.

Prerequisite:

- AED mode (refer to 11.4.4 Overview AED Mode on page 79) or manual mode (refer to 11.4.7 Overview Manual Mode on page 83) is called up

*To start or stop the metronome, proceed as follows:*

1. To start the metronome and select a metronome mode, press softkey [Metronome] several times until the required metronome mode is marked in yellow.

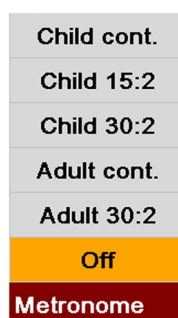

Figure 11-6 Selecting the metronome mode

*The softkey context menu closes.*

*The selected metronome mode is displayed.*

*The metronome starts in the selected mode.*

- To switch off the metronome, press softkey [Metronome] several times until *Off* is highlighted.

*The softkey context menu closes.*

*The selected metronome mode *Off* is displayed.*

*The metronome is switched off.*

## 11.7 corPatch CPR for assistance with thorax compressions (option)

The corPatch CPR function assists the user with cardiopulmonary resuscitation providing important information on the quality of the thorax compressions.

The corPatch CPR disposable sensor used with the corpuls1 measures the rate and depth of a thorax compression. The user can react directly to the feedback of the corPatch CPR sensor and take appropriate action.

Among the information are the display of the current CPR rate as well as the compression depth curve of the current thorax compressions.

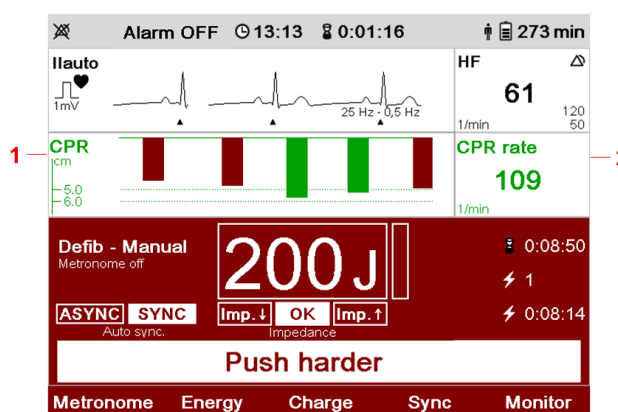

Figure 11-7 corPatch CPR feedback information

- Curve CPR compression depth
- Vital parameter CPR rate

The CPR rate is displayed as vital parameter and the CPR curve as curve, depending on the settings configured by the user (refer to 13.4.1 Submenu item Curves on page 118)/(refer to 13.4.2 Submenu item Parameters on page 120) and the user OPERATOR (refer to Table 14-14 Settings manual mode (user OPERATOR) - List View on page 147). The CPR curve is synchronous to the ECG curve.

The corPatch CPR disposable sensor can be used in all operating modes.



If a patient is under 8 years of age, the use of the corPatch CPR disposable sensor is not recommended.





During resuscitation the user must assess the status of the patient independently of the feedback information provided by the corPatch CPR.



The corPatch CPR disposable sensor is protected by one or more of the following US patents: 7,074,199; 7,108,665; 7,429,250; 8,147,433; 7,220,235

**CPR rate**

If the compressions performed by the user fall below a rate of 70 /min or exceed 150 /min, the corpuls1 no longer issues readings. The metronome indicates acoustically the compressions.

**CPR compression depth**

Speech- and text messages, as well as the colour of the bars in the CPR curve signal to the user whether the quality of the thorax compressions is sufficient (green bars) or can be optimised (red bars).



The corpuls1 represents thorax compressions also in green if they exceed the recommended depth.

Pertaining to CPR compression depth, there are three different speech- and text messages available:

- **Push harder**
- **Push harder, fully release**
- **Good compressions**

If the recommended CPR compression depth of the thorax compressions has not been reached, the speech- and text message **Push harder** is played. The corpuls1 repeats these at an interval of 7 s until the recommended depth of the thorax compressions has been reached. Then the speech- and text message **Good compressions** is played.

The speech- and text message **Push harder, fully release** appears at fixed intervals to remind the user to fully release the thorax. If the message **Fully release** is played depends on the settings configured by the user OPERATOR.

The speech- and text messages do not appear if:

- The device is charging in manual mode.
- During the ECG analysis in AED mode.
- The device is ready for releasing a defibrillation shock (first 10 s).
- The shock has been released in AED mode and until the message **Perform CPR** appears.
- The preShock phase is active in AED mode (up to approx. 30 s after ready for shock).
- The compression frequency falls below 70 /min or exceeds 150 /min.
- The ventilation phase of the metronome is active, including the five higher-pitched compression tones indicating the upcoming ventilation phase.



If neither the AED- nor the manual mode is active and the curve is visible, as e. g. in monitoring mode or pacer mode, only voice messages, no text messages pertaining to the CPR depth appear.

The reference range of CPR compression depth is 5.0 cm to 6.0 cm / 2.0 in to 2.4 in.

### 11.7.1 Warnings



#### WARNING!

##### User error during application of CPR!

If the user does not completely release the pressure during the phase between compressions when administering CPR, the feedback from the corpuls1 may be negative.

- ▶ Release the pressure on the patient's chest completely during the phase between compressions.



#### CAUTION!

##### Wrong application of the corPatch CPR disposable sensor!

If the corPatch CPR disposable sensor is applied for too long, the skin of the patient may be affected (red patches and skin irritation).

- ▶ Replace corPatch CPR disposable sensors at last 24 hours after first use.



#### CAUTION!

##### Ineffective rest position of the corPatch CPR disposable sensor!

The detection of the rate and depth of chest compressions may be compromised by movement affecting the corPatch CPR disposable sensor.

- ▶ Protect the corPatch CPR disposable sensor from movement during complete application.

### 11.7.2 Supporting CPR with the corPatch CPR Disposable Sensor

When the following prerequisites are met, the user can start therapy.

Prerequisite:

- The corPatch CPR disposable sensor is connected to the patient (refer to 11.10.4 corPatch CPR Disposable Sensor (Accessories) on page 108)
- AED mode (refer to 11.4.6 Calling up the Manual Mode on page 82) or manual mode (refer to 11.4.3 Calling up AED Mode on page 78) is called up

Metronome is activated (optional) (refer to 11.6.2 Starting the Metronome on page 97)

To support the cardiopulmonary resuscitation with the corPatch CPR disposable sensor proceed as follows:

1. Start chest compressions

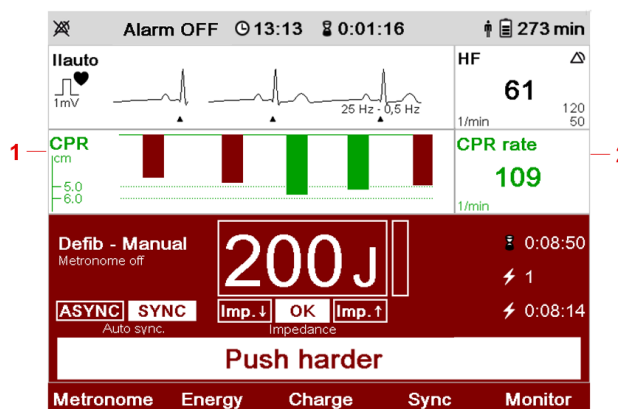

Figure 11-8 Function corPatch CPR in manual mode (after first thorax compressions)

*In the curve for CPR compression depth of the user interface, first green/red bars are visible.*

2. One of the following situations occurs:
  - a) The corpul<sup>1</sup> issues the voice- and text message **Push harder** or **Push harder, fully release**.  
*Adjust the CPR compression depth to the recommended CPR compression depth.*
  - b) The corpul<sup>1</sup> issues the voice- and text message **Good compressions**.  
*The CPR compression depth is suitable.*
3. Continue or finish standardised or locally valid resuscitation protocol with chest compressions to completion.  
*The CPR compression depth should be adjusted to the recommended CPR compression depth.*

*Cardiopulmonary resuscitation is complete.*

## 11.8 Connecting Therapy Electrodes to the Device

The user can connect therapy electrodes to the corpul<sup>1</sup>.

### 11.8.1 corPatch easy Electrodes or Shock Paddles (Accessories)

With the therapy socket it is possible to connect corPatch easy electrodes or shock paddles.

Shock paddles must be used in combination with the therapy master cable.

Prerequisite:

- For operation as defibrillator shock paddles instead of corPatch easy electrodes are recommended
- Shock paddles and therapy master cable are present

*To connect the shock paddles to the therapy master cable, proceed as follows:*

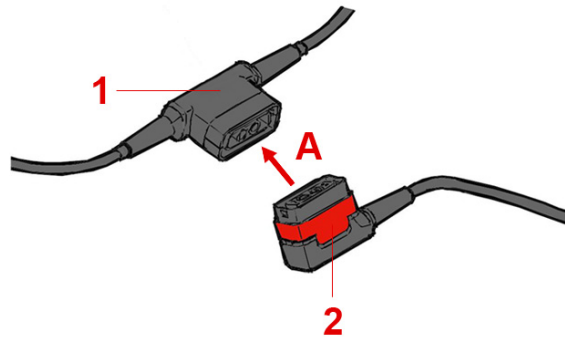

Figure 11-9 Connecting shock paddles to the therapy master cable

- 1 Plug of shock paddles
- 2 Red plug of therapy master cable

1. Connect (item A) the black plug of the shock paddles (item 2) to the red plug of therapy master cable (item 1).

*The plug of the shock paddles engages with a click and the shock paddles are connected to the therapy master cable.*



Connect the corPatch easy electrodes directly to the corpuls1. Shock paddles must only be used in combination with the therapy master cable.

*To connect corPatch easy electrodes or the therapy master cable to the device, proceed as follows:*

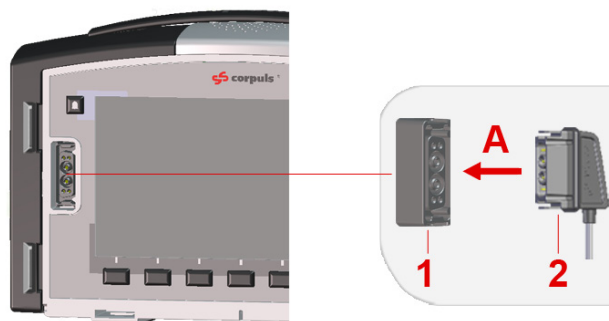

Figure 11-10 Connect corPatch easy electrodes or the therapy master cable

- 1 Therapy socket

2 Plug of the therapy electrodes or black plug of the therapy master cable

1. Connect (item A) the black plug of the therapy electrodes or the therapy master cable (item 2) to the therapy socket (item 1).

*The message **Therapy cable connected, select patient class** appears.*

2. Select the patient class/-group depending on the connected corPatch easy electrodes with the softkeys [Adult]/[Child]/[Neonate]. Alternatively, select the patient class/-group via the configuration dialogue (refer to 13.8.2 Submenu item Patient class/-group on page 130).

*The corPatch easy electrodes or the therapy master cable are connected to the corpuls1.*

### 11.8.2 corPatch CPR Disposable Sensor (Accessories)

The socket CPR allows to connect the corPatch CPR disposable sensor.

Prerequisite:

- The corPatch CPR disposable sensor and corPatch CPR intermediate cable are present.

*To connect the corPatch CPR disposable sensor to the corPatch CPR intermediate cable, proceed as follows:*

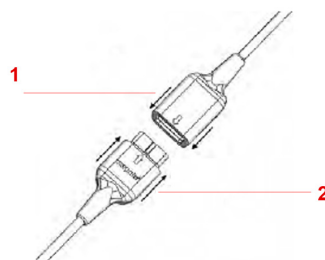

Figure 11-11 Connect the corPatch CPR intermediate cable to the corPatch CPR disposable sensor

- 1 Connector corPatch CPR disposable sensor
- 2 Plug of the corPatch CPR intermediate cable

1. Connect the connector of the corPatch CPR disposable sensor (item 1) to the connector of the corPatch CPR intermediate cable (item 2).

*The plug of the corPatch CPR disposable sensor clicks into place and the the corPatch CPR disposable sensor is connected to the corPatch CPR intermediate cable.*

To connect the corPatch CPR disposable sensor proceed as follows:

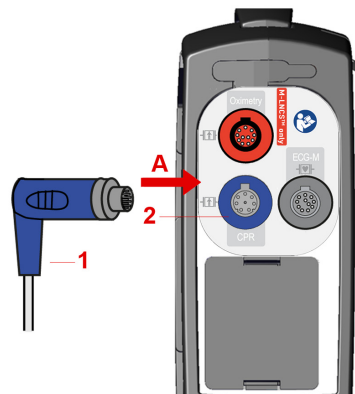

Figure 11-12 Connecting corPatch CPR disposable sensor

- 1 Plug of the corPatch CPR intermediate cable
- 2 CPR interface

1. Connect (item A) the plug of the corPatch CPR intermediate cable (item 1) to the CPR interface (item 2).

*The message **CPR sensor cable connected** appears.*

### 11.8.3 Shock Spoons (Accessories)

The therapy socket allows to connect shock spoons.

The shock spoons consist of shock spoon electrodes, shock spoon holders and the pertaining Y-adapter for connecting to the corpuls1 (see Shock Spoon manual, P/N: 04137).



Before using the shock spoons, read and understand the additional user manual (P/N 04137).

Prerequisite:

- The shock spoon electrodes are connected with the holder and the pertaining Y-adapter.

*To connect the shock spoons with the Y-adapter to the corpuls1, proceed as follows:*

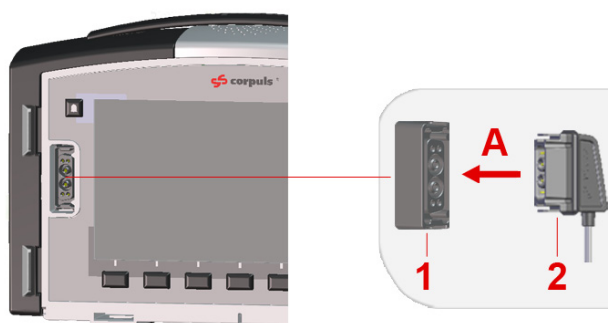

Figure 11-13 Connecting the shock spoons with the Y-adapter

- 1 Therapy socket
- 2 Plug Y-adapter

1. Connect (item A) the black plug of the Y-adapter (item 2) to the therapy socket (item 1).  
*Shock spoons are connected to the corpuls1.*

## 11.9 Preparing the Patient

Before the user attaches electrodes to the patient, the patient has to be prepared.

*To prepare the patient, proceed as follows:*

1. If necessary, remove excessive hair from where the electrodes will be attached.
2. If necessary, clean and dry the skin where the electrodes will be attached.

### 11.10 Attaching therapy electrodes to the patient

If the user has connected the therapy electrodes to the corpuls1, the user can attach the therapy electrodes to the patient.

#### 11.10.1 corPatch easy Electrodes for Defibrillation and Cardioversion (Accessories)

To be able to perform therapy, the user has to apply the therapy electrodes to the patient.

Prerequisite:

- Therapy electrodes are connected (refer to 11.8.1 corPatch easy Electrodes or Shock Paddles (Accessories) on page 101)

The patient is prepared (refer to 11.9 Preparing the Patient on page 105)

*To attach the corPatch easy electrodes to the patient, proceed as follows:*

1. Open the package of the corPatch easy electrodes and take out the corPatch easy electrodes.

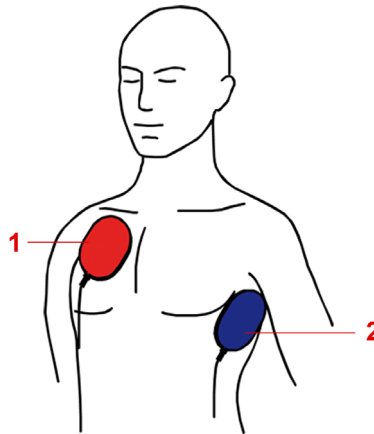

Figure 11-14 Connecting corPatch easy electrodes for defibrillation and cardioversion to the patient

- 1 Red-labelled electrode
- 2 Blue-labelled electrode



Apply the corPatch easy electrodes from the centre outwards so that no air pockets are included.

2. Attach the red-labelled electrode to the right of the sternum on the thorax (item 1).
3. Attach the blue-labelled electrode beside apex of the heart on the lower left of the thorax (item 2).

*corPatch easy electrodes are attached to the patient.*

### 11.10.2 corPatch easy Electrodes for Pacer Therapy (Accessories)

To be able to perform therapy, the user has to apply the therapy electrodes to the patient.

Prerequisite:

- Therapy electrodes are connected (refer to 11.8.1 corPatch easy Electrodes or Shock Paddles (Accessories) on page 101)

The patient is prepared (refer to 11.9 Preparing the Patient on page 105)



*To attach the corPatch easy electrodes to the patient, proceed as follows:*

1. Open the package of the corPatch easy electrodes and take out the corPatch easy electrodes.

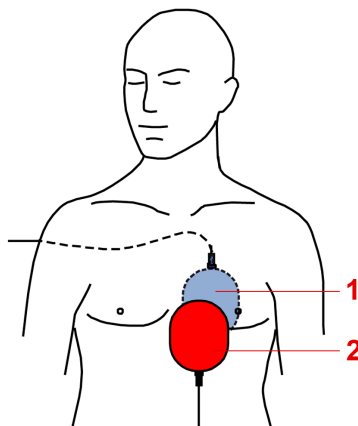

Figure 11-15 Attaching corPatch easy electrodes to the patient

- 1 Red-labelled electrode
- 2 Blue-labelled electrode



Apply the corPatch easy electrodes from the centre outwards so that no air pockets are included.

2. Place the red-labelled electrode on the thorax at the level of the bottom third of the sternum (item 2).
3. Place the blue-labelled electrode on the back beside the vertebral column beneath the left shoulder blade (item 1).

*corPatch easy electrodes are attached to the patient.*

### 11.10.3 Shock Paddles for Defibrillation and Cardioversion (Accessories)

To be able to perform therapy, the user has to apply the therapy electrodes (shock paddles) to the patient.

Prerequisite:

- Therapy electrodes/shock paddles are connected (refer to 11.8.1 corPatch easy Electrodes or Shock Paddles (Accessories) on page 101)
- The patient is prepared (refer to 11.9 Preparing the Patient on page 105)

*To place the shock paddles on the thorax of the patient, proceed as follows:*

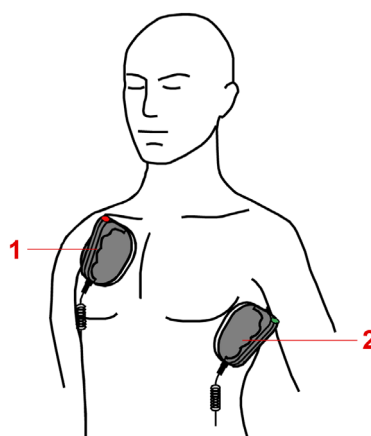

Figure 11-16 Place the shock paddles on the thorax of the patient

- 1 STERNUM shock paddle
- 2 APEX shock paddle

1. Completely wet the electrode surfaces of the shock paddles with defibrillation electrode gel.
2. Place the STERNUM shock paddle to the right of the sternum (item 1).
3. Place the APEX shock paddle on the lower left of the thorax beside apex of the heart (item 2).

*Shock paddles are placed on the thorax of the patient.*

#### 11.10.4 corPatch CPR Disposable Sensor (Accessories)

To be able to perform therapy, the user has to apply the corPatch CPR disposable sensor to the patient.

Prerequisite:

- corPatch CPR disposable sensor is attached
- The patient is prepared (refer to 11.9 Preparing the Patient on page 105)

*To connect the corPatch CPR disposable sensor to the patient, proceed as follows:*

1. Open the package of the corPatch CPR disposable sensor and take out the corPatch CPR disposable sensor.
2. Remove the protective foil from the corPatch CPR disposable sensor on the side facing the patient.

3. Position the corPatch CPR disposable sensor on the patient's thorax as shown in the picture.

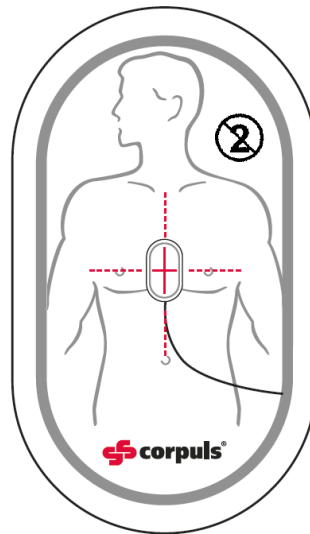

Figure 11-17 Attach the corPatch CPR disposable sensor



---

Apply the corPatch CPR disposable sensor from the centre outwards so that no air pockets are included.

---

*The corPatch CPR disposable sensor is connected to the patient.*

## 11.11 End Therapy Mission

After finishing the mission, several measures have to be taken.

***To finish the mission, proceed as follows:***

1. To prevent accidental re-use, immediately dispose correctly of the disposable therapy electrodes (corPatch easy) and disposable sensors (corPatch CPR).
2. Clean and disinfect the corpuls1, ECG monitoring cable, pulse oximetry intermediate cable/sensor and re-usable therapy electrodes (Shock paddles/shock spoons) (refer to 15.6 Cleaning and Disinfection on page 172).

## 12 Mission Data Management

---

This chapter contains information on mission data storage in the corpuls1 and how to handle the SD card.

### 12.1 Mission Data Storage

The corpuls1 automatically creates a new mission data record and a unique mission number each time it is switched on. Within a mission data record, all events are marked with date and time and patient data can be assigned.

During the mission the corpuls1 stores all generated mission data in the internal memory as e. g. vital parameters, curves, alarm data and entries in the alarm history, audio recordings or screenshots. In the internal memory of the device, a maximum of 25 typical missions can be stored, which remain secure even in the event of a power failure. The completed mission data records that have not yet been transferred to the SD card are saved during use by the corpuls1. The symbol  in the status line indicates that the data are being saved.

If the user switches off the corpuls1 (refer to 6.2 Switching the Device on and off on page 26), the corpuls1 saves all generated mission data from the internal memory to the SD card.



All saved mission data can be viewed with the evaluation software (refer to 1 Evaluation Software on page 1). Thus, e. g. for alarm events date and time from the beginning to the end of the alarm condition, as well as the associated alarm limits are logged.

---



If the user switches off the corpuls1 and switches the corpuls1 on again, the entries in the alarm history have been deleted and are no longer available.

---

#### 12.1.1 Warnings

The following warnings inform the user of possible hazards when using the corpuls1.

##### NOTICE!

###### Premature removal of the SD card!

Can lead to data loss due to data being saved incorrectly or not at all.

- ▶ If the symbol  appears in the status line, the SD card must remain inserted in the corpuls1 and the corpuls1 must remain switched on.
  - ▶ Before removing the SD card, switch off the corpuls1.
-

## 12.2 SD Card (Accessories)

The SD card allows to save all generated mission data and to view those with (P/N 04135) on a PC. To be able to assign the generated mission data unequivocally, the user has to configure the date and the time (refer to 13.9 Menu Item System on page 132).

## 13 Settings Main Menu

The user can log in to the corpuls1 at different user levels. Logging in is only possible at one user level at a time. For every authorisation level, different settings are available.

This chapter describes the settings for the user DEFAULT and the user MAN. DEFIB.. This chapter is structured analogously to the menu.

### 13.1 Overview Settings

The following illustration gives an overview of the user interface elements.

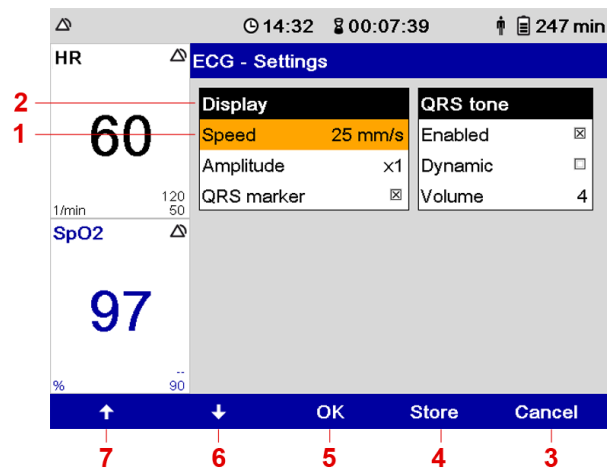

Figure 13-1 Overview User interface elements

Item	Element	Description
1	List box	Indicates the currently selected setting.
2	List	Indicates a list. A list contains one or more list boxes.
3	Softkey [Cancel]	The following functions are available: Cancel selection, close element without saving changes.
4	Softkey [Store]	Allows to save changed settings until the user switches off the corpuls1.
5	Softkey [OK]	The following functions are available: Select and confirm settings, activate <input checked="" type="checkbox"/> and deactivate <input type="checkbox"/> checkbox.
6	Softkey [Down]	The following functions are available: Navigate between list boxes and between settings.

Item	Element	Description
7	Softkey [Up]	The following functions are available: Navigate between list boxes and between settings.

Table 13-1 Overview User interface elements

## 13.2 Changing Settings

If a submenu is called up, the user can change settings.

*To change settings, proceed as follows:*

1. Navigate to the list box by pressing the softkey [Up] or [Down].  
*The list box is marked in yellow.*
2. Select setting by pressing softkey [OK].  
*The current setting is emphasised in bold font.*



---

To abort the process, press softkey [Cancel].

---

3. Navigate between the settings by pressing the softkey [Up] or [Down] and confirm the required setting with the softkey [OK].



---

If the list box has a checkbox, select  or deselect  the checkbox by pressing the softkey [OK].

---

4. To change further settings, repeat steps 1 to 3.
5. The following options are available:
  - a) To save the settings, press softkey [Store].  
*The menu is closed. The settings will be stored until the user switches off the corpuls1.*
  - b) To retain the previous settings and close the menu, press the softkey [Cancel].  
*The menu is closed. The settings have not been stored.*

## 13.3 Menu item Alarms

The menu item "Alarms" allows to configure settings for alarms.

### 13.3.1 Warnings

The following warnings inform the user of possible hazards when using the corpuls1.



**WARNING!**

**Potential danger with regard to alarm presets when changing to another area of application!**

If the user moves to an application area where other alarm presets are needed, the currently set alarm presets may be inappropriate and result in misinterpretations.

- ▶ When changing to another application area, adjust the alarm presets.

### 13.3.2 Submenu item Limits

The submenu item ▶ "Limits" allows to set alarm limits for vital parameters. The lower limit  and the upper limit  can be configured by the user for the patient groups Adult, Child and Neonate.

*To open the configuration dialogue, proceed as follows:*

1. In the menu "Alarms" select ▶ "Autolimits".

*The configuration dialogue for selecting the patient group Adult is open.*

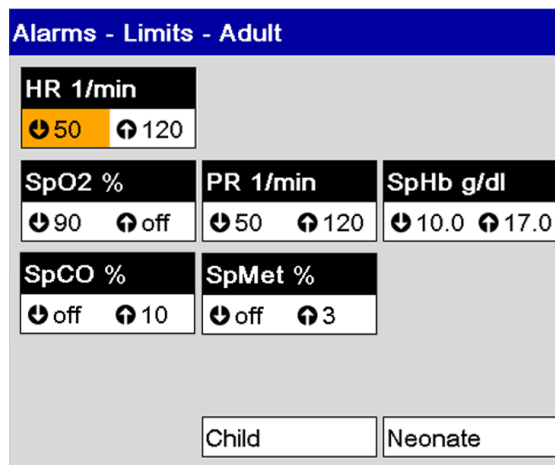













Alarms - Limits - Adult		
<b>HR 1/min</b>		
 50	 120	
<b>SpO2 %</b>	<b>PR 1/min</b>	<b>SpHb g/dl</b>
 90  off	 50  120	 10.0  17.0
<b>SpCO %</b>	<b>SpMet %</b>	
 off  10	 off  3	
<input type="text" value="Child"/>		<input type="text" value="Neonate"/>

Figure 13-2 Configuration Alarm limits (example adult)

*The list box HR 1/min is open and the lower alarm limit is marked in yellow.*

2. Press softkey [OK].
3. Set lower alarm limit.

Navigate to the required alarm limit by pressing the softkey [Up] or [Down] and confirm with softkey [OK].



To navigate quickly through the characters hold down the softkey [Up] or [Down] for approx. 2 s. until the required value has been reached.

If necessary, combine with individual steps.

4. Navigate to the upper alarm limit by pressing the softkey [Down] and confirm with softkey [OK].



5. Enter upper limit.  
Navigate to the required alarm limit by pressing the softkey [Up] or [Down] and confirm with softkey [OK].
6. Navigate to the next list box *SpO2 %* by pressing the softkey [Down].  
*The list box *SpO2 %* is open and the lower alarm limit is marked in yellow.*
7. Repeat steps 2 - 5 until all necessary alarm limits are set.



The list box *Child* allows switching to the limits for the patient group Child. The list box *Neonate* allows switching to the limits for the patient group Neonate.

#### List Alarm limits

List box	Description	Values
<i>HR 1/min</i>	Allows to change the lower alarm limit ⬇️ for the heart rate.	25 /min to 150 /min, in increments of five
	Allows to change the upper alarm limit ⬆️ for the heart rate.	70 /min to 250 /min, in increments of five
<i>SpO2 %</i>	Allows to change the lower alarm limit ⬇️ for the oxygen saturation.	Off; 65 % to 99 %, in increments of one
	Allows to change the upper alarm limit ⬆️ for the oxygen saturation.	90 % to 100 %, in increments of one; off
<i>PR 1/min</i>	Allows to change the lower alarm limit ⬇️ for the peripheral pulse rate.	Off; 25 /min to 100 /min, in increments of five
	Allows to change the upper alarm limit ⬆️ for the peripheral pulse rate.	70 /min to 200 /min, in increments of five;
<i>SpCO %</i> (only with Masimo Rainbow SET Technology)	Allows to change the lower alarm limit ⬇️ for the carboxyhaemoglobin concentration.	Off; 0 % to 100 %, in increments of one
	Allows to change the upper alarm limit ⬆️ for the carboxyhaemoglobin concentration.	1 % to 100 %, in increments of one; off
<i>SpMet %</i> (only with Masimo Rainbow SET Technology)	Allows to change the lower alarm limit ⬇️ for the peripheral methaemoglobin concentration.	Off; 0 %, 100 % in increments of one
	Allows to change the upper alarm limit ⬆️ for the methaemoglobin concentration.	1 % to 100 %, in increments of one; off





List box	Description	Values
<i>SpHb g/dl</i> (only with Masimo Rainbow SET Technology)	Allows to change the lower alarm limit  for the total haemoglobin levels.	Off; 3.0 g/dl to 12.0 g/dl, in increments of 0.1
	Allows to change the upper alarm limit  for the total haemoglobin levels.	10.0 g/dl to 22.0 g/dl, in increments of 0.1;
<i>SpHb mmol/l</i> (only with Masimo Rainbow SET Technology)	Allows to change the lower alarm limit  for the total haemoglobin levels.	Off; 1.9 mmol/l to 7.5 mmol/l, in increments of 0.1
	Allows to change the upper alarm limit  for the total haemoglobin levels.	6.2 mmol/l to 13.7 mmol/l, in increments of 0.1

Table 13-2 Limits - List Alarm limits



The corpuls1 does not allow to enter overlapping values for the upper and lower alarm limits. Setting extreme alarm limits may render the alarm system useless.





Exception with the lower alarm limit of SpO<sub>2</sub>:  
If the user disables the vital parameter SpO<sub>2</sub> and the value of the lower alarm limit is less than 90 %, the corpuls1 automatically increases the lower alarm limit to 90 %.



There are no alarm limits for the vital parameter perfusion index (PI). Therefore the list box *Vital parameter autolimits* is not available. If there is low perfusion, the corpuls1 issues the alarm message "Oxi: Low perfusion". The vital parameter field is coloured/inverted and shows a question mark (?). Additionally, all other oximetry vital parameter fields (e. g. SpO<sub>2</sub>) show also a dot mark ..

### 13.3.3 Submenu item Auto limits

The submenu item ► "Auto limits" allows to set automatic limits for the vital parameters. The lower limit  and the upper limit  can be configured by the user for the currently selected patient class. The user can adopt the autolimits also via the the vital parameter context menu (refer to 7.4 Vital Parameter Context Menu on page 38).

**To open the configuration dialogue, proceed as follows:**

1. In the menu "Alarms" select ► "Auto limits".

*The configuration dialogue is open.*

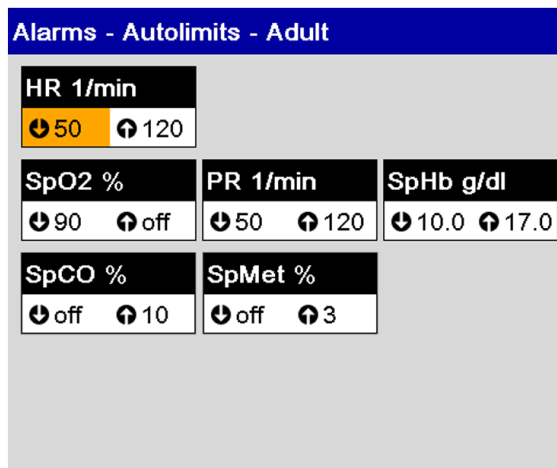

Figure 13-3 Configuration Alarm autolimits

### 13.3.4 Submenu item Settings

The submenu item ► "Settings" allows to change the volume of alarms.

*To open the configuration dialogue, proceed as follows:*

1. In the menu "Alarms", select ► "Settings".

*The configuration dialogue is open.*

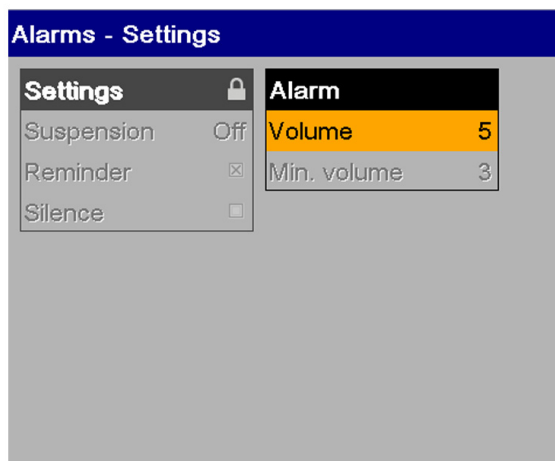

Figure 13-4 Settings Alarms

List  
Alarm

List box	Description	Values
<i>Volume</i>	Allows to change the volume of the alarms.	3 to 10, in increments of one 3 = soft 10 = loud

Table 13-3 Settings Alarms - List Alarms



The user DEFAULT/MAN. DEFIB. cannot set the volume below the minimal volume.

## 13.4 Menu item Signals

The menu item "Signals" allows to configure settings of the displayed curves and vital parameters.

### 13.4.1 Submenu item Curves

The submenu item ► "Curves" allows to configure which curves are displayed in monitoring mode.

*To open the configuration dialogue, proceed as follows:*

1. In the menu "Signals", select ► "Curves".

*The configuration dialogue is open.*

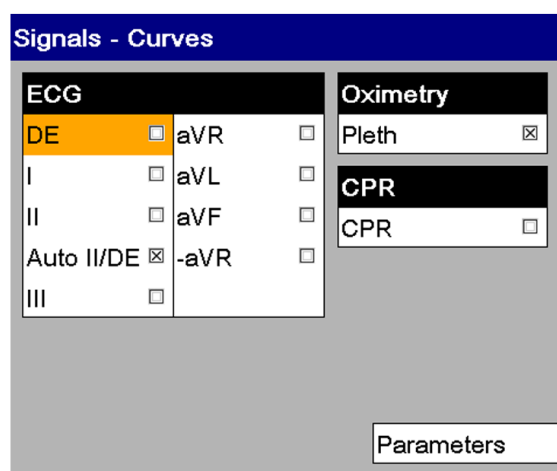

Figure 13-5 Settings Curves



The list box *Parameters* allows switching to the parameter settings.



The corpuls1 can display a maximum of three curves in monitoring mode.

To display a third curve in monitoring mode, the vital parameter position should be set to *Left* or *Right*, not to *Top*.

#### List ECG

List box	Description	Values
<i>DE</i>	Allows to show or hide the DE lead.	<input checked="" type="checkbox"/> ; <input type="checkbox"/>
<i>I</i>	Allows to show or hide the I lead.	<input checked="" type="checkbox"/> ; <input type="checkbox"/>
<i>II</i>	Allows to show or hide the II lead.	<input checked="" type="checkbox"/> ; <input type="checkbox"/>
<i>Auto II/DE</i>	Allows to show or hide the AutoII/DE lead. The Auto II/DE curve alternates automatically between the DEauto lead and the IIauto lead.	<input checked="" type="checkbox"/> ; <input type="checkbox"/>
<i>III</i>	Allows to show or hide the III lead.	<input checked="" type="checkbox"/> ; <input type="checkbox"/>
<i>aVR</i>	Allows to show or hide the aVR lead.	<input checked="" type="checkbox"/> ; <input type="checkbox"/>
<i>aVL</i>	Allows to show or hide the aVL lead.	<input checked="" type="checkbox"/> ; <input type="checkbox"/>
<i>aVF</i>	Allows to show or hide the aVF lead.	<input checked="" type="checkbox"/> ; <input type="checkbox"/>
<i>-aVR</i>	Allows to show or hide the -aVR lead.	<input checked="" type="checkbox"/> ; <input type="checkbox"/>

Table 13-4 Settings Curves - List ECG

#### List Oximetry

List box	Description	Values
<i>Pleth</i>	Allows to show or hide the pleth curve.	<input checked="" type="checkbox"/> ; <input type="checkbox"/>

Table 13-5 Settings Curves - List Oximetry

#### List CPR

List box	Description	Values
<i>CPR</i>	Allows to show or hide the CPR curve.	<input checked="" type="checkbox"/> ; <input type="checkbox"/>

Table 13-6 Settings Curves - List CPR

### 13.4.2 Submenu item Parameters

The submenu item ► "Parameters" allows to configure which parameter fields are displayed in monitoring mode. Allows to configure the position of the vital parameter fields and to select the interval for trends.

*To open the configuration dialogue, proceed as follows:*

1. In the menu "Signals", select ► "Parameters".

*The configuration dialogue is open.*

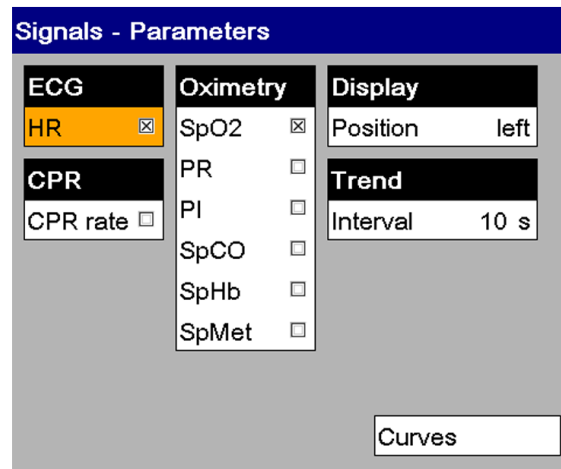

Figure 13-6 Settings Vital parameters



The list box *Curves* allows switching to the curve settings.



The corpuls1 can display a maximum of four vital parameters in monitoring mode, depending on the position of the vital parameters.

If the vital parameter position is set to *Left* or *Right*, the corpuls1 can display three curves simultaneously, but not if set to *Top*.

List  
ECG

List box	Description	Values
HR	Allows to show or hide the vital parameter field HR.	<input checked="" type="checkbox"/> ; <input type="checkbox"/>

Table 13-7 Settings Vital parameters - List ECG

List  
Oximetry

List box	Description	Values
SpO2	Allows to show or hide the vital parameter field SpO2.	<input checked="" type="checkbox"/> ; <input type="checkbox"/>

List box	Description	Values
<i>PR</i>	Allows to show or hide the vital parameter field PR.	<input checked="" type="checkbox"/> ; <input type="checkbox"/>
<i>PI</i>	Allows to show or hide the vital parameter field PI.	<input checked="" type="checkbox"/> ; <input type="checkbox"/>
<i>SpCO</i>	Allows to show or hide the vital parameter field SpCO. (Available only with with Masimo Rainbow SET Technology)	<input checked="" type="checkbox"/> ; <input type="checkbox"/>
<i>SpHb</i>	Allows to show or hide the vital parameter field SpHb. (Available only with with Masimo Rainbow SET Technology)	<input checked="" type="checkbox"/> ; <input type="checkbox"/>
<i>SpMet</i>	Allows to show or hide the vital parameter field SpMet. (Available only with with Masimo Rainbow SET Technology)	<input checked="" type="checkbox"/> ; <input type="checkbox"/>

Table 13-8 Settings Vital parameters - List Oximetry

List  
Display

List box	Description	Values
<i>Position</i>	Allows to change the position of the vital parameter fields on the screen.	Left, top, right

Table 13-9 Settings Vital parameters - List Display

List  
Trend

List box	Description	Values
<i>Interval</i>	Allows to change the interval at which the corpuls1 records the readings of the displayed vital parameters.  From these recorded readings the corpuls1 calculates a mean value for each displayed vital parameter. The user can view the logged mean values with .	10 s to 60 s, in steps of 10 s-

Table 13-10 Settings Vital parameters - List Trend

List  
CPR

List box	Description	Values
<i>CPR rate</i>	Allows to show or hide the CPR rate.	<input checked="" type="checkbox"/> ; <input type="checkbox"/>

Table 13-11 Settings Vital parameters - List CPR

### 13.4.3 Submenu item Views

The submenu item ► "Views" allows to store select or also to store four views for the monitoring mode. The factory settings of the corpuls1 include default settings for four views (refer to K Reset to Factory Settings on page 246).

These views are available to the user for the current mission.

*To open the configuration dialogue, proceed as follows:*

1. In the menu "Signals", select ► "Views".

*The configuration dialogue is open.*

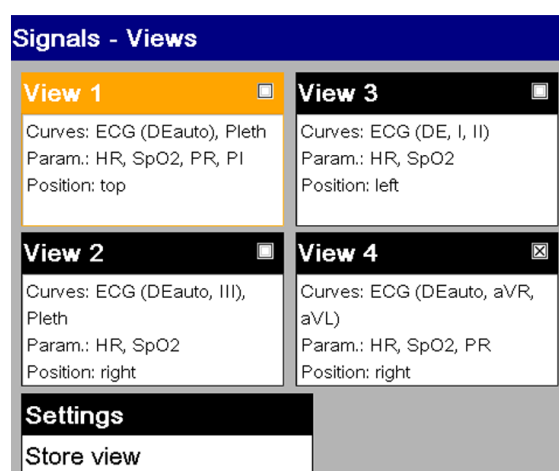

Figure 13-7 Settings Views

Prerequisites:

- The required curves have been configured for a new view in the menu "Signals" ► "Curves" (refer to 13.4.1 Submenu item Curves on page 118)
- The required vital parameters have been configured for a new view in the menu "Signals" ► "Parameters" (refer to 13.4.2 Submenu item Parameters on page 120)
- The menu "Signals" ► "Views" has been opened

*To save a selected view, proceed as follows:*

1. Navigate to the list box *Store view* by pressing the softkey [Up] or [Down] and confirm by pressing the softkey [OK].
2. To store the selected view, navigate with the softkey [Up] or [Down] to the required view (e. g. *View 2*) and confirm with the softkey [OK].

*The selected view has been stored. In the configuration dialogue "Signals - Views" the configuration can be reviewed in the selected view (e. g. *View 2*).*



If the configuration has been stored in the system settings by the user OPERATOR, the new views are available permanently.





The corpuls1 deletes a stored view by overwriting it with a new view.



To retain the previous settings and close the configuration dialogue, press the softkey [Cancel].

*To select a view, proceed as follows:*

1. Navigate to the required view by pressing the softkey [Up] or [Down] and confirm with softkey [OK].

*The checkbox is selected .*



The view can also be chosen via the softkey context menu Views (refer to 7.6.2 Softkey Context Menu View on page 44)

## 13.5 Menu item ECG

The menu item "ECG" allows to configure settings for ECG monitoring.

### 13.5.1 Submenu item Settings

The submenu item ► "Settings" allows to change the representation of the ECG and settings for the QRS tone.

*To open the configuration dialogue, proceed as follows:*

1. In the menu "ECG", select ► "Settings".

*The configuration dialogue is open.*

ECG - Settings	
Display	QRS tone
Speed 25 mm/s	Enabled <input checked="" type="checkbox"/>
Amplitude x1	Dynamic <input type="checkbox"/>
QRS marker <input checked="" type="checkbox"/>	Volume 4

Figure 13-8 Settings ECG

List Display	List box	Description	Values
	<i>Speed</i>	Allows to select the sweep speed for the ECG curve.	12.5 mm/s, 25 mm/s, 50 mm/s
	<i>Amplitude</i>	Allows to change the amplitude of the ECG curve.	x0.25 to x2; Auto x0.25 = flat amplitude x2 = high amplitude Auto = automatic adjustment
	<i>QRS Marker</i>	Allows to show or hide the QRS markers.	<input checked="" type="checkbox"/> ; <input type="checkbox"/>

Table 13-12 ECG Settings - List Display

List QRS Tone	List box	Description	Values
	<i>Enabled</i>	Allows to enable or disable the QRS tone.	<input checked="" type="checkbox"/> ; <input type="checkbox"/>
	<i>Dynamic</i>	The pitch of the QRS tone changes in relation on the oxygen saturation. A high-pitched tone signals good oxygen saturation. A low-pitched tone signals poor oxygen saturation. <i>NOTE:</i> The dynamic QRS tone is only available, if the device is equipped with the pulse oximetry option (refer to 10.4 Pulse Oximetry Monitoring (Option) on page 63).	<input checked="" type="checkbox"/> ; <input type="checkbox"/>
	<i>Volume</i>	Allows to change the volume of the QRS tone.	3 to 10, in steps of one 3 = soft 10 = loud

Table 13-13 ECG Settings - List QRS tone

## 13.6 Menu item Defib

The menu item "Defib" allows to configure settings for the defibrillation mode.

### 13.6.1 Submenu item Metronome

The submenu item ► "Metronome" allows to change the volume of compression tones and ventilation tones of the metronome.

*To open the configuration dialogue, proceed as follows:*

1. In the menu "Defib", select ► "Metronome".

The configuration dialogue is open.

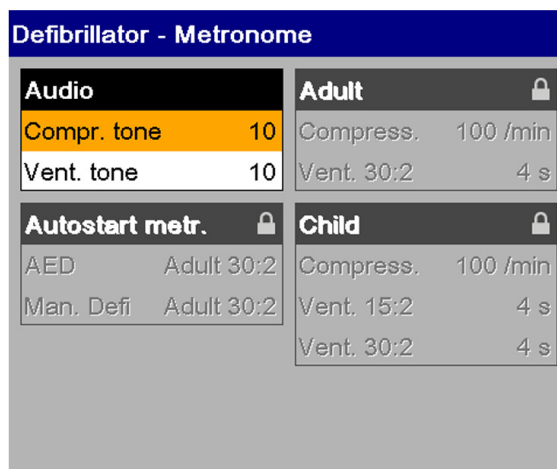

Figure 13-9 Settings Metronome

List  
Audio

List box	Description	Values
<i>Compr. tone</i>	Allows to change the volume of the compression tone of the metronome.	3 to 10, in increments of one 3 = soft 10 = loud
<i>Vent. Tone</i>	Allows to change the volume of the ventilation tone of the metronome.	3 to 10, in increments of one; OFF 3 = soft 10 = loud

Table 13-14 Settings Metronome - List Audio

### 13.6.2 Submenu item CPR

The submenu item ► "CPR" allows to configure settings for the corPatch CPR function.

*To open the configuration dialogue, proceed as follows:*

1. In the menu "Defib", select ► "CPR".

*The configuration dialogue is open.*

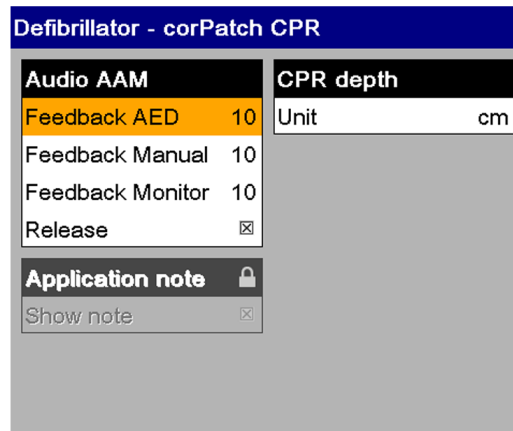

Figure 13-10 Settings corPatch CPR

List  
Application note

List box	Description	Values
Show note	Allows to display an application note concerning the use of the corPatch CPR disposable sensor in AED- and manual mode.	<input checked="" type="checkbox"/> ; <input type="checkbox"/>

Table 13-15 Settings corPatch CPR - List Application note

## 13.7 Menu item Oximetry

The menu item "Oximetry" allows to configure settings for pulse oximetry monitoring.

### 13.7.1 Submenu item Settings

The submenu item ► "Settings" allows to change the representation of the plethysmogramme, the settings of the pulse tone and further settings for pulse oximetry monitoring.

*To open the configuration dialogue, proceed as follows:*

1. In the menu "Oximetry", select ► "Settings".

*The configuration dialogue is open.*

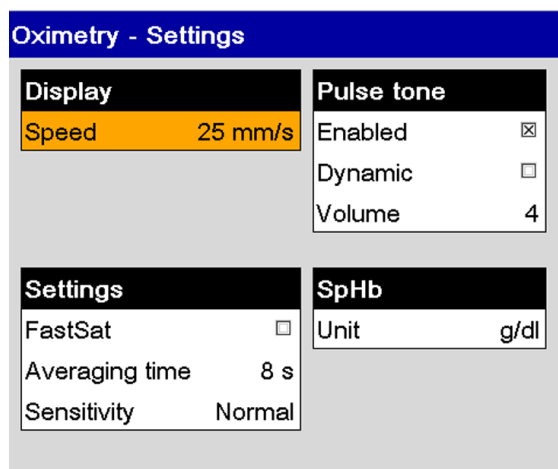

Figure 13-11 Settings Pulse oximetry

List Display	List box	Description	Values
		<i>Speed</i>	Allows to select the sweep speed for the plethysmogramme.

Table 13-16 Settings Pulse oximetry - List Display

List Settings	List box	Description	Values
		<i>FastSat</i>	Allows to enable or disable the FastSat <sup>®</sup> algorithm.
	<i>Averaging time</i>	Allows to change the averaging time. The longer the averaging time, the more stable are the measured values. Longer averaging times delay the response of the pulse oximeter and reduce the measured variations of SpO <sub>2</sub> and pulse rate.	2 s to 4 s 4 s to 6 s, 8 s, 10 s, 12 s, 14 s, 16 s

List box	Description	Values
<i>Sensitivity</i>	<p>Allows to adapt the sensitivity of the pulse oximeter.</p> <p><i>Normal</i>: Recommended for typical monitoring situations in which patients are monitored continuously, as e. g. in intensive care units.</p> <p><i>APOD™</i>: Recommended for situations where there is a high probability of the pulse oximetry sensor becoming detached from the patient or where patients are not visually monitored continuously. Offers a safe and fast detection if the pulse oximetry sensor is loose and therefore erroneous readings for pulse rate and arterial oxygen saturation are detected.</p> <p><i>MAX</i>: Recommended for patients with low perfusion and when the corpuls1 issues an alarm in <i>APOD™</i> or <i>Normal</i> sensitivity mode. This mode is not recommended for situations where patients are not continuously monitored visually. Offers no protection if the pulse oximetry sensor is loose and therefore erroneous readings for pulse rate and arterial oxygen saturation are detected.</p>	Normal, <i>APOD™</i> , MAX

Table 13-17 Settings Pulse oximetry - List Settings

List  
Pulse tone

List box	Description	Values
<i>Enabled</i>	<p>Allows to enable or disable the pulse tone.</p> <p>As long as the QRS tone (refer to 13.5 Menu item ECG on page 123) is sounding, the pulse tone is muted.</p>	<input checked="" type="checkbox"/> ; <input type="checkbox"/>
<i>Dynamic</i>	<p>Allows to enable or disable the dynamic pulse tone.</p> <p>If the checkbox is selected the pitch of the pulse tone changes in relation to the oxygen saturation. The pulse tone has to be activated. A high-pitched tone signals good oxygen saturation. A low-pitched tone signals poor oxygen saturation. If the checkbox is deselected the pulse tone does not change in relation to the oxygen saturation.</p>	<input checked="" type="checkbox"/> ; <input type="checkbox"/>
<i>Volume</i>	Allows to change the volume of the pulse tone.	3 to 10, in steps of one 3 = soft 10 = loud

Table 13-18 Settings Pulse oximetry - List Pulse tone

List  
SpHb

List box	Description	Values
Unit	Allows selecting a different measurement unit for SpHb.	g/dl, mmol/l

Table 13-19 Settings Pulse oximetry - List SpHb

### 13.7.2 Submenu item Info

The submenu item ► "Info" allows to display information on the pulse oximetry measuring options.

*To open the information on the system, proceed as follows:*

1. In the menu "Oximetry", select ► "Info".

*Information on the oximetry function is open.*

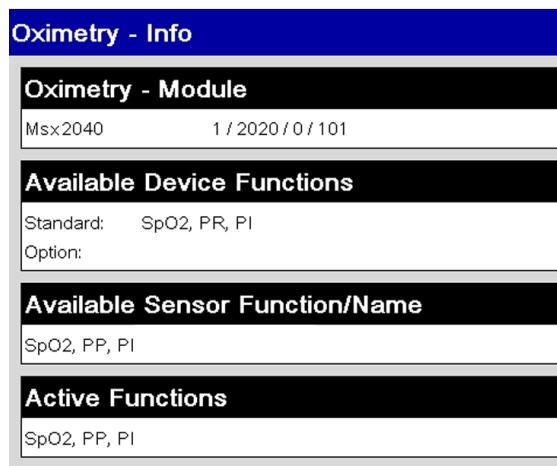

Figure 13-12 Information Pulse oximetry function

## 13.8 Menu item Patient

The menu item "Patient" allows to enter data pertaining to the patient and to display screenshots.

### 13.8.1 Submenu item Screenshots

The submenu item ► "Screenshots" allows to display screenshots.

*To display the saved screenshots, proceed as follows:*

1. In the menu "Patient", select ► "Screenshots".

*The screenshot viewer shows the most recent screenshot. The status line shows the symbol*



### 13.8.2 Submenu item Patient class/-group

The submenu item ► "Patient class" allows to select the patient class/-group.

*To select a patient group, proceed as follows:*

1. In the menu "Patient", select ► "Patient class".

*The submenu item is open.*



Figure 13-13 Select patient class/-group.



To abort the process, press softkey [Cancel].

2. Select patient class/-group with the softkeys.

*The status line shows the symbol for the patient class/-group (refer to 7.1 Structure of the User Interface on page 33).*

### 13.8.3 Submenu item Enter Data

The submenu item ► "Enter data" allows to enter patient data.

*To enter patient data, proceed as follows:*

1. In the menu "Patient", select ► "Patient class".

*The patient data are open.*

Patient - Enter data	
Patient ID 1	--
Patient ID 2	--
First name	--
Last name	--
Sex	--
Date of birth	-- . -- . ----
Age	-- years
Weight	-- kg
Height	-- cm

Figure 13-14 Overview Patient data

2. Navigate to the list box (*Patient ID 1/2, Last name/name*) by pressing the softkey [Up] or [Down].

*The list box is marked in yellow.*



3. Press softkey [OK].

*The input window for entering data is open.*



Figure 13-15 Entering patient data

4. Entering patient data.

Navigate with softkey [Right] to the required character (single steps or quick pass through (refer to 13.3.2 Submenu item Limits on page 114)) and press softkey [OK]. Navigate to other characters with softkey [Right] or [Left] and press softkey [OK].

By selecting the symbol < the user OPERATOR can delete the last entry.

5. Press softkey [Save].

*The list box entry is saved.*

6. To enter further data, repeat steps 2 to 4.

7. Navigate to the list box *Sex* by pressing the softkey [Up] or [Down].

*The list box is marked in yellow.*

8. Press softkey [OK].

*The input window for entering data is open.*

9. Navigate to the required value (–, *male*, *female*) by pressing the softkey [Up] or [Down] and confirm with softkey [OK].

*The list box entry is saved.*

10. Navigate to the list boxes (*Date of birth*, *Age*, *Weight*, *Height*) by pressing the softkey [Up] or [Down].

*The list box is marked in yellow.*

11. Press softkey [OK].

*The input window for entering data is open.*

12. To enter the *Birth date*, navigate to the required value with the softkeys [Up], [Down], to enter *Age*, *Weight* and *Height* with the softkeys [Right] or [Left] (individual steps or quick pass through (refer to Figure 13-2 Configuration Alarm limits (example adult) on page 114)) and confirm with softkey [OK].

*The list box is marked in yellow.*



---

After a value has been entered in the list box *Date of birth* the list box *Age* is greyed out.

---

*The list boxes show the entered patient data.*

## 13.9 Menu Item System

The menu item "System" allows to open the mission administration, to configure system settings for the corpuls1 and to display system information on the corpuls1. The user can log in at another user level.

### 13.9.1 Submenu item Mission

The submenu item ► "Mission" allows to mark the current mission as test mission.

#### Opening the mission administration

*To open the mission administration, proceed as follows:*

1. In the menu "System", select ► "Mission".

*The mission administration is open and allows to mark the current mission as test mission.*

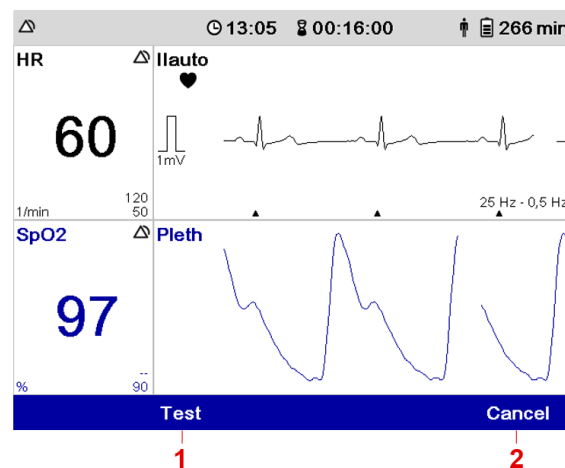

Figure 13-16 Mission administration

- 1 Softkey [Test]
- 2 Softkey [Cancel]

**Test mission** The user can mark the current mission as test mission.



The corpuls1 recognises a connected Testload/Testbox/corpuls simulator and automatically offers to mark this mission as test mission. The confirmation prompt **Mark as test mission?** appears.

*To mark the current mission as test mission, proceed as follows:*

1. Press softkey [Test].

*The confirmation prompt **Mark as test mission?** appears.*



To abort the process, press softkey [Cancel].

2. Press softkey [OK].

*The dialogue closes. The current mission has been marked as test mission. Marking the mission*

as a test mission does not influence the mission data, but allows to filter the mission data in .

### 13.9.2 Submenu item Settings

The submenu item ► "Settings" allows to configure system settings for the corpuls1.

*To open the system settings, proceed as follows:*

1. In the menu "System", select ► "Settings".

*The system settings (1) are open.*

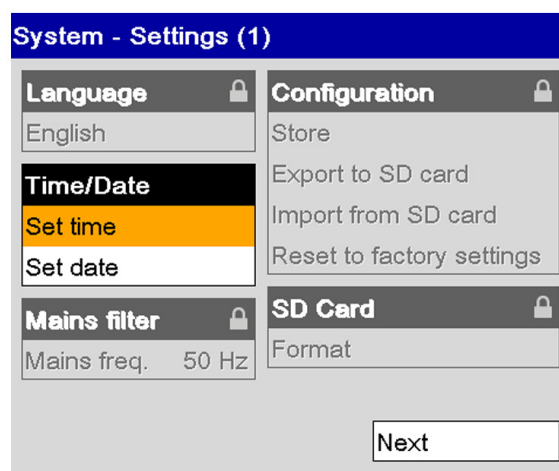

Figure 13-17 System settings (1)

2. Press softkey [OK].  
*The list box Set Time is marked in yellow.*
3. Enter the value.  
Navigate to the required value by pressing the softkey [Up] or [Down] and confirm with softkey [OK].



The user can navigate to the required value by using individual steps or the quick pass through (refer to 13.3.2 Submenu item Limits on page 114).

4. Enter the value.  
Navigate to the required value by pressing the softkey [Up] or [Down] and confirm with softkey [OK].
5. Navigate to the list box Set Date by pressing the softkey [Down].  
*The list box Set date is marked in yellow.*
6. Press softkey [OK].  
*The list box Set Date is open and the day value marked in yellow.*
7. Enter the value.

Navigate to the required value by pressing the softkey [Up] or [Down] and confirm with softkey [OK].

*The month value is marked in yellow.*

8. To enter values for month and year, repeat step 7.

List  
Time/Date

List box	Description	Values
Set Time	Allows to set the current time.	Hours (h) and minutes (m), in format <i>hh:mm</i>
Set Date	Allows to set the current date.	Days (d), months (m) and years (y), in format <i>dd:mm:yyyy</i>

Table 13-20 System settings (1) - List Time/Date

The list box *Next* allows to navigate to System settings (2).

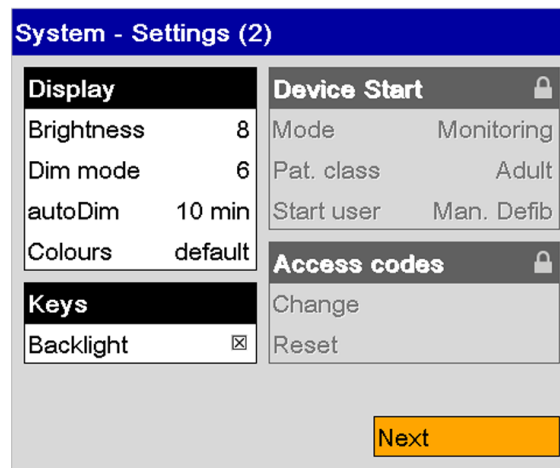

Figure 13-18 System settings (2)

List  
Display

List box	Description	Values
Brightness	Allows to adjust the brightness of the display.	1 to 10, in steps of one 1 = dark 10 = light
Dim mode	Allows to adjust the brightness of the display to energy saving Dim mode.	1 to 7, in steps of one 1 = dark 7 = light

List box	Description	Values
<i>autoDim</i>	Allows to select the time period after which the display is automatically dimmed. If the user does not work with the corpuls1 within the configured time period or no new alarm is issued or confirmed, the display is automatically dimmed. If the value <i>Off</i> is selected, the display is not automatically dimmed.	2 min to 10 min, in steps of one; off
<i>Colours</i>	Allows to adjust the colour settings of the display.	Default, inverted

Table 13-21 System settings (2) - List Display

List Keys

List box	Description	Values
<i>Backlight</i>	Allows to enable or disable in AED mode the backlighting of the <b>Analyse</b> key and the <b>Shock</b> key. Allows to enable or disable in manual mode the backlighting of the <b>Shock</b> key. If the user is expected to press one of those keys, the respective key is flashing red.	<input checked="" type="checkbox"/> ; <input type="checkbox"/>

Table 13-22 System settings (2) - List Keys

The list box *Next* allows to navigate to the Master data.

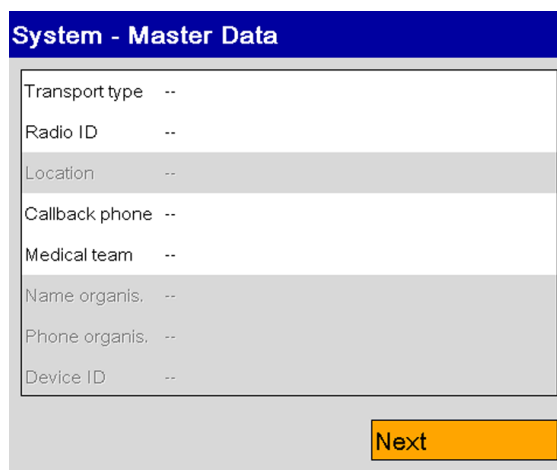

Figure 13-19 Master data

The user can enter master data in monitoring mode.

**To enter master data, proceed as follows:**

1. Navigate to the list box by pressing the softkey [Up] or [Down].  
*The list box is marked in yellow.*

2. Press softkey [OK].

*The input window for entering data is open.*

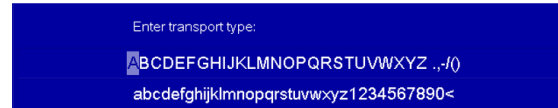

Figure 13-20 Entering master data

3. Entering master data.

Navigate with softkey [Right] to the required character (single steps or quick pass through (refer to 13.3.2 Submenu item Limits on page 114)) and press softkey [OK]. Navigate to other characters with softkey [Right] or [Left] and press softkey [OK].

By selecting the symbol < the user OPERATOR can delete the last entry.

4. To enter further master data, repeat steps 1 to 3.

*The list boxes show the entered master data.*

### 13.9.3 Submenu item Info

The system information displays the respective versions of software- and hardware components.

*To open system information, proceed as follows:*

1. In the menu "System", select ► "Info".

*The system information 1 is open.*

System - System Information 1		
System	SW version	Serial number
corpuls <sup>1</sup>	C1_2.0.0	-
HV	2.7 / 5	
PIF	1.45	
ECG	2.5	
CPR	0.5	
Ms2040	1 / 2017 / 0 / 101	

Figure 13-21 System information 1

The softkey [SysInfo2] allows to navigate to System information 2.

System - System Information 2		
Board	Comp. Status	Serial number
P600	0x0300	E1311467
P601	0x0000	E1317220
P605	0x0000	E1210813

Figure 13-22 System information 2

### 13.9.4 Submenu item Login

The user can log in to the corpuls1 at various user levels.

*To log in a user, proceed as follows:*

1. In the menu "System", select ► "Login".

*The input window for entering data is open.*

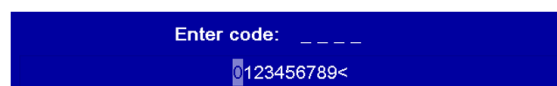

Figure 13-23 Entering the access code

2. Enter the 4-digit access code.



---

To obtain the access code for a user level, contact the operator.

---

By selecting the symbol < the user OPERATOR can delete the last entry.

*The message **User [XY] logged in successfully** appears. User is logged in.*

## 14 Settings Main menu (User level OPERATOR)

---

This chapter describes the settings for the user level OPERATOR (Person responsible for the device). This chapter follows the structure of the menu of the device.

### 14.1 Menu item Alarms

The menu item "Alarms" allows to configure settings for alarms.

#### 14.1.1 Warnings

The following warnings inform the user of possible hazards when using the corpuls1.



#### WARNING!

##### Acoustic alarm signal not audible!

If the surrounding noises are louder than the acoustic alarm signal, the alarm may no longer be heard.

- ▶ Always set the minimal volume louder than surrounding noises.
- 



#### WARNING!

##### Potential danger with regard to alarm presets when changing to another area of application!

If the user moves to a application area where other alarm presets are needed, the currently set alarm presets may be inappropriate and result in misinterpretations.

- ▶ When changing to another application area, adjust the alarm presets.
- 

#### 14.1.2 Submenu item Settings

The submenu item ▶ "Settings" allows to configure the suspension of alarms, the reminder signal and the alarm tone silencing function and to change the volume as well as the minimum volume of alarms.

*To open the configuration dialogue, proceed as follows:*

1. In the menu "Alarms", select ▶ "Settings".

*The configuration dialogue is open.*



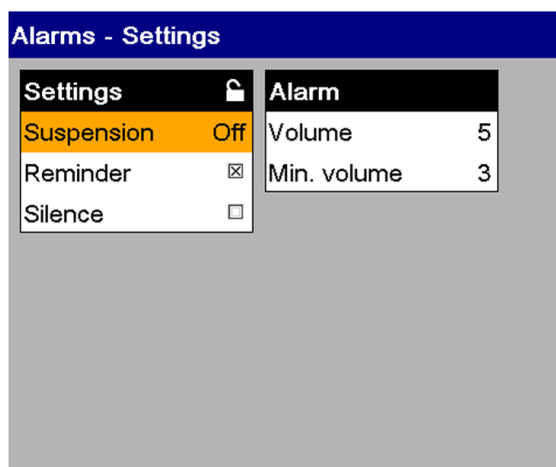

Figure 14-1 Settings Alarms (user OPERATOR)

List Settings

List box	Description	Values
<i>Suspension</i>	Allows to change the duration of the alarm suspension for patient alarms (refer to 7.8 Alarm Suspension on page 47). Selecting the value <i>Off</i> allows to disable the suspension of patient alarms altogether, so that the user is not able to suspend alarms. Selecting the value <i>perm.</i> allows to enable the suspension of patient alarms permanently, so that the user is able to suspend alarms indefinitely.	Off; perm.; 180 s, 120 s, 90 s, 60 s, 30 s
<i>Reminder</i>	Allows to enable or disable the reminder signal for existing patient alarms in the following situations:	<input checked="" type="checkbox"/> ; <input type="checkbox"/>
<i>Silence</i>	Allows to enable or disable the alarm tone silencing function for existing alarms.	<input checked="" type="checkbox"/> ; <input type="checkbox"/>

Table 14-1 Settings Alarms (user OPERATOR) - List Settings



The user can activate either the function Alarm suspension or Alarm tone silencing, but not both simultaneously.

If the list box *Silence* is selected, the list box *Suspension* is automatically set to the value *Off*. The settings for the list box *Reminder* can be configured independently from the settings of the list box *Suspension* and *Silence*.

List  
Alarm

List box	Description	Values
<i>Min. volume</i>	Allows to change the volume of the alarms.	3 to 10, in increments of one 3 = soft 10 = loud

Table 14-2 Settings Alarms - List Alarms



The user DEFAULT/MAN. DEFIB. cannot set the volume below the minimal volume.

## 14.2 Menu item ECG

The menu item "ECG" allows to configure settings for ECG monitoring.

### 14.2.1 Submenu item Filter

The submenu item ► "Filter" allows to change the frequency for the high pass- and low pass filter.



#### WARNING!

#### Wrong ECG filter set!

Can lead to misinterpretation of the ECG.

► ECG filter settings should be changed exclusively by authorised trained personnel.

*To open the configuration dialogue, proceed as follows:*

1. In the menu "ECG", select ► "Filter".

*The configuration dialogue is open.*

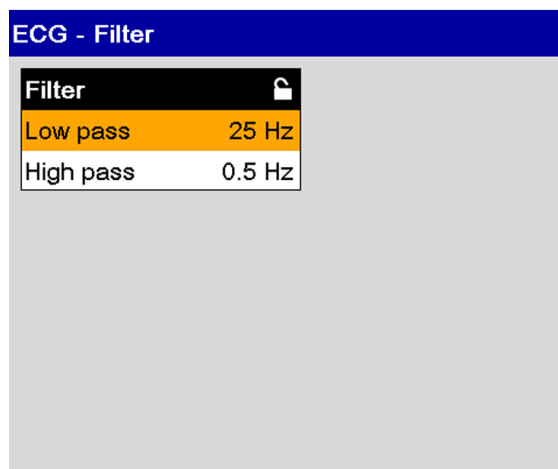

Figure 14-2 Settings ECG filter (user OPERATOR)

List  
Filter

List box	Description	Values
<i>Low pass</i>	Allows to change the frequency. The low pass filter suppresses interference in the upper frequency range of the ECG curve.	25 Hz, 40 Hz, 150 Hz
<i>High pass</i>	Allows to change the frequency. The high-pass filter suppresses interference in the lower frequency range of the ECG curve.	0.05 Hz, 0.12 Hz, 0.25 Hz, 0.5 Hz

Table 14-3 Settings ECG filter (user OPERATOR) - List Filter



The filter settings for the DE lead are pre-configured and fixed at 0.5 Hz to 25 Hz.

### 14.3 Menu item Defib

The menu item "Defib" allows to configure settings for the defibrillation mode.

#### 14.3.1 Submenu item Metronome

The submenu item ► "Metronome" allows to change the metronome settings.

- Volume of compression tones and ventilation tones
- Autostart values for ventilation frequency and -duration.
- Ventilation frequency and -duration

*To open the configuration dialogue, proceed as follows:*

1. In the menu "Defib", select ► "Metronome".

*The configuration dialogue is open.*

Defibrillator - Metronome			
<b>Audio</b>		<b>Adult</b>	
Compr. tone	10	Compress.	100 /min
Vent. tone	10	Vent. 30:2	4 s
<b>Autostart metr.</b>		<b>Child</b>	
AED	Adult 30:2	Compress.	100 /min
Man. Defi	Adult 30:2	Vent. 15:2	4 s
		Vent. 30:2	4 s

Figure 14-3 Settings Metronome (user OPERATOR)

List box	Description	Values
<i>Compr.</i>	Allows to change the frequency for the metronome.	80 /min to 120 /min, in increments of 5 /min
<i>Vent. 30:2</i>	Allows to change the duration of ventilation for the metronome to mode 30:2.	3 s to 6 s, in increments of 1 s

Table 14-4 Settings Metronome (user OPERATOR) - List Adult

List box	Description	Values
<i>Compr.</i>	Allows to change the frequency for the metronome.	80 /min to 140 /min, in increments of 5 /min
<i>Vent. 15:2</i>	Allows to change the duration of ventilation for the metronome to mode 15:2.	3 s to 6 s, in increments of 1 s
<i>Vent. 30:2</i>	Allows to change the duration of ventilation for the metronome to mode 30:2.	3 s to 6 s, in increments of 1 s

Table 14-5 Settings Metronome (user OPERATOR) - List child

List box	Description	Values
<i>AED</i>	Allows to configure the metronome settings when the AED mode is set as starting mode.	Off; Adult 30:2; Adult cont.; Child 30:2; Child 15:2; Child cont.

List box	Description	Values
<i>Man. Defib</i>	Allows to configure the metronome settings when the manual mode is set as starting mode.	Off; Adult 30:2; Adult cont.; Child 30:2; Child 15:2; Child cont.

Table 14-6 Settings Metronome (user OPERATOR) - List Autostart metr.

### 14.3.2 Submenu item Settings

The submenu item ► "Settings" allows to configure settings for the defibrillation modes.

*To open the configuration dialogue, proceed as follows:*

1. In the menu "Defib", select ► "Settings".

*The configuration dialogue is open.*

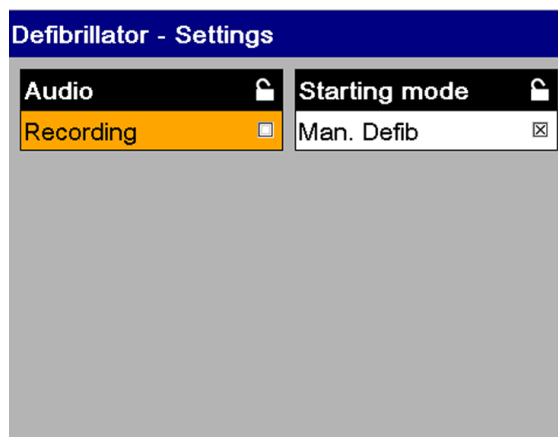

Figure 14-4 Settings Defibrillator (user OPERATOR)

List  
Audio

List box	Description	Values
<i>Recording</i>	Allows to record the surrounding noises in AED mode and manual mode.  NOTE: In manual mode, the recording starts when an energy level higher than zero is set, in AED mode when the <b>Analyse.</b> key is pressed.	<input checked="" type="checkbox"/> ; <input type="checkbox"/>

Table 14-7 Settings Defibrillator (user OPERATOR) - List Audio

List box	Description	Values
<p>List Starting mode</p> <p>Man. Defib</p>	<p>Allows to set a defibrillation mode as default.</p> <p>If the checkbox is selected, the manual mode is enabled first. If the checkbox is deselected, the AED mode is enabled first.</p>	<p><input checked="" type="checkbox"/>;</p> <p><input type="checkbox"/></p>

Table 14-8 Settings Defibrillator (user OPERATOR) - List Starting mode

### 14.3.3 Submenu item AED

The submenu item ► "AED" allows to configure settings for the AED mode.

*To open the configuration dialogue, proceed as follows:*

1. In the menu "Defib", select ► "AED".

*The configuration dialogue is open.*

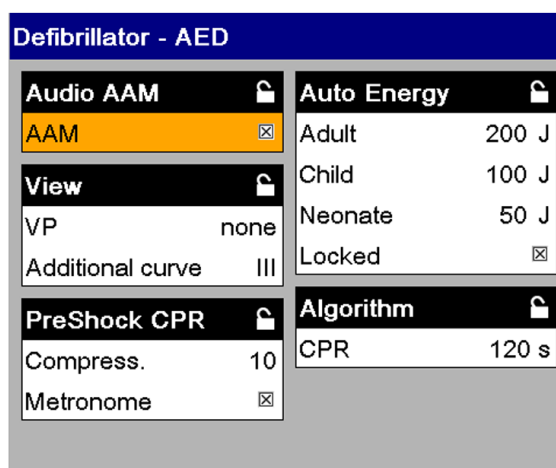

Figure 14-5 Settings AED mode (user OPERATOR)

List box	Description	Values
<p>List Audio AAM</p> <p>AAM</p>	<p>Allows to disable or enable the audio instructions AAM (Acoustic Advisory Mode) of the resuscitation protocol.</p>	<p><input checked="" type="checkbox"/>;</p> <p><input type="checkbox"/></p>

Table 14-9 Settings AED mode (user OPERATOR) - List Audio AAM

List View

List box	Description	Values
<i>VP</i>	Allows to display one, two or no vital parameters in AED mode.	none, HR, SpO2, HR/SpO2 CPR rate, SpO2/CPR rate HR/CPR rate NOTE: e. g. HR/SpO2 = HR and SpO2
<i>Additional Curve</i>	Allows to change the second curve in AED mode.	I, II, III, aVR, aVL, aVF, -aVR, Pleth, CPR, DE

Table 14-10 Settings AED mode (user OPERATOR) - List View

List preShock CPR

List box	Description	Values
<i>Compress.</i>	Allows to change the number of compressions for preShock CPR measures.	none, 8, 10, 15, 20
<i>Metronome</i>	Allows to enable the metronome for preShock CPR.	<input checked="" type="checkbox"/> ; <input type="checkbox"/>

Table 14-11 Settings AED mode (user OPERATOR) - List Algorithm

List Algorithm

List box	Description	Values
<i>CPR</i>	Allows to change the duration of CPR measures after a shock release.	60 s, 90 s, 120 s, 180 s

Table 14-12 Settings AED mode (user OPERATOR) - List Algorithm

List Auto Energy

List box	Description	Values
<i>Adult</i>	Allows to configure the energy level that is pre-set for adults when the AED mode is set as starting mode.	1 J to 200 J, in the pertaining increments for individual steps.
<i>Child</i>	Allows to configure the energy level that is pre-set for children when the AED mode is set as starting mode.	1 J to 100 J, in the pertaining increments for individual steps.
<i>Neonate</i>	Allows to configure the energy level that is pre-set for neonates when the AED mode is set as starting mode.	1 J to 50 J, in the pertaining increments for individual steps.

List box	Description	Values
Locked	Allows locking the softkey context menu Energy in AED mode.	<input checked="" type="checkbox"/> ; <input type="checkbox"/>

Table 14-13 Settings AED mode (user OPERATOR) - List Auto Energy



Entering values for *Auto Energy* can be done in individual steps or with quick pass through (refer to 13.3.2 Submenu item Limits on page 114).



The *Auto Energy* settings are only effective after re-starting the corpus1.

The user OPERATOR can configure the second curve field and one vital parameter field in defibrillation mode.

***To configure the second curve field and one vital parameter field, proceed as follows:***

1. Press the key **Main menu**.  
*The menu has been opened.*
2. Navigate to the menu item "Defib" ► "AED" or "Defib" ► "Manual" by pressing the softkey [Up] or [Down].  
*The respective menu items are marked in yellow.*
3. To select the menu item, press softkey [OK].  
*The submenu item is opened.*



To close the submenu, press softkey [Back] once or twice.

4. Adjust the settings in the list box *Additional curve* (refer to 13.4.1 Submenu item Curves on page 118) and *VP* (refer to 13.4.2 Submenu item Parameters on page 120).  
*An additional curve field or vital parameter field are configured.*
5. To save the changed settings, the following options are available:
  - a) To save the settings, press softkey [Store].  
*The menu is closed. The settings will be stored until the user switches off the corpus1.*
  - b) To retain the previous settings and close the menu, press the softkey [Cancel].  
*The menu is closed. The settings have not been stored.*

#### 14.3.4 Submenu item Manual

The submenu item ► "Manual" allows to configure settings for the manual mode.



**WARNING!**

Off ready tone deprives the user of the acoustic knowledge of a shock readiness!

If the ready tone is disabled by the OPERATOR, there is a risk of unintentional shock delivery to the user.

- ▶ When disabling the ready tone by the OPERATOR, consider the consequences for the users.

To open the configuration dialogue, proceed as follows:

1. In the menu "Defib", select ▶ "Manual".

The configuration dialogue is open.

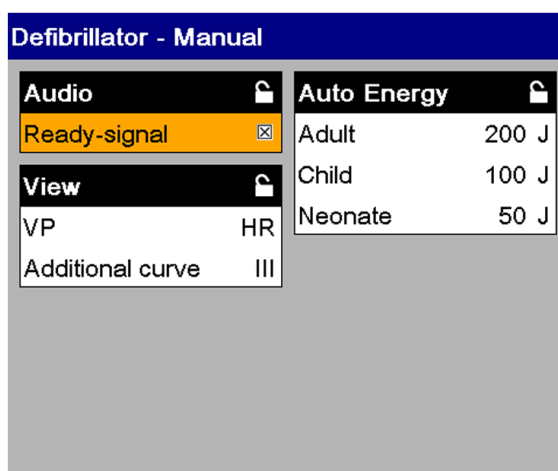

Figure 14-6 Settings manual mode (user OPERATOR)

List box	Description	Values
<i>VP</i>	Allows to display one, two or no vital parameters in manual mode.	none, HR, SpO2, HR/SpO2 CPR rate, SpO2/CPR rate HR/CPR rate NOTE: e. g. HR/SpO2 = HR and SpO2
<i>Additional Curve</i>	Allows to change the second curve in manual mode.	I, II, III, aVR, aVL, aVF, -aVR, Pleth, CPR, DE

Table 14-14 Settings manual mode (user OPERATOR) - List View



To configure as user OPERATOR the second curve field and a vital parameter field, proceed as described for *submenu item AED* (refer to 14.3.3 Submenu item AED on page 144).

List  
Auto Energy

List box	Description	Values
<i>Adult</i>	Allows to configure the energy level that is pre-set for adults when the manual mode is set as starting mode.	1 J to 200 J, in the pertaining increments for individual steps.
<i>Child</i>	Allows to configure the energy level that is pre-set for children when the manual mode is set as starting mode.	1 J to 100 J, in the pertaining increments for individual steps.
<i>Neonate</i>	Allows to configure the energy level that is pre-set for neonates when the manual mode is set as starting mode.	1 J to 50 J, in the pertaining increments for individual steps.

Table 14-15 Settings manual mode (user OPERATOR) - List Auto Energy



Entering values for *Auto Energy* can be done in individual steps or with quick pass through (refer to 13.3.2 Submenu item Limits on page 114).



The *Auto Energy* settings are valid for the therapy electrodes corPatch easy and shock paddles, but not for shock spoons. For shock spoons, the initial energy level is always 15 J. The user can then increase the shock energy up to 50 J via the softkey context menu Energy.



The *Auto Energy* settings are only effective after re-starting the corpuls1.

List  
Ready-signal

List box	Description	Values
<i>Ready-signal</i>	Allows to enable or disable the charging tone (ready signal). If the energy for the shock is available, the charging tone (ready signal) is sounding.	<input checked="" type="checkbox"/> ; <input type="checkbox"/>

Table 14-16 Settings manual mode (user OPERATOR) - List Ready-signal

### 14.3.5 Submenu item CPR

The submenu item ► "CPR" allows to configure settings for the corPatch CPR function.

**To open the configuration dialogue, proceed as follows:**

1. In the menu "Defib", select ► "CPR".

The configuration dialogue is open.

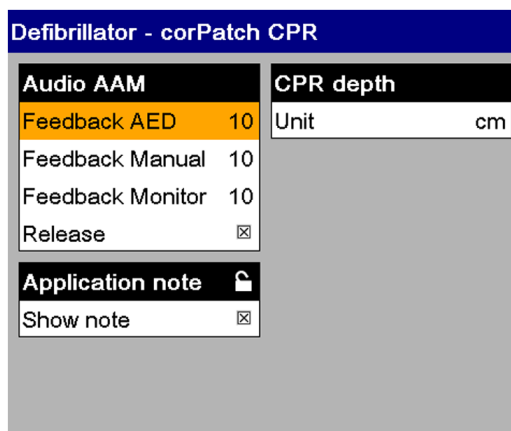

Figure 14-7 Settings corPatch CPR (user OPERATOR)

List  
Audio AAM

List box	Description	Values
<i>Feedback AED</i>	Allows to change the volume of the speech messages for corPatch CPR feedback in AED mode.	Off; 3 to 10, in increments of one
<i>Feedback Manual</i>	Allows to change the volume of the speech messages for corPatch CPR feedback in manual mode.	Off; 3 to 10, in increments of one
<i>Feedback Monitor</i>	Allows to change the volume of the speech messages for corPatch CPR feedback in monitoring mode.	Off; 3 to 10, in increments of one
<i>Release</i>	Allows to enable or disable the speech messages for corPatch CPR feedback <i>Push harder</i> and <i>Fully release</i> .	<input type="checkbox"/>

Table 14-17 Settings corPatch CPR (user OPERATOR) - List Audio AAM

### 14.4 Menu item Pacer (Option)

The menu item "Pacer" allows to configure settings for the pacer mode.



The menu "Pacer" is only available, if the pacer mode has been called up (refer to 11.5.2 Calling up the Pacer Mode on page 91).

*To open the configuration dialogue, proceed as follows:*

1. In the main menu, select "Pacer".

*The configuration dialogue is open.*

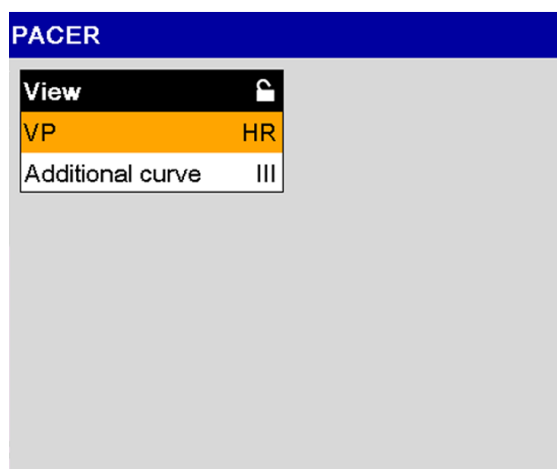

Figure 14-8 Settings Pacer (user OPERATOR)

List View	List box	Description	Values
	VP	Allows to show or hide one, two or no vital parameters in pacer mode.	none, HR, SpO2, HR/SpO2, CPR rate, SpO2/CPR rate, HR/CPR rate NOTE: e. g. HR/SpO2 = HR and SpO2
	Additional Curve	Allows to change the second curve in pacer mode.	I, II, III, aVR, aVL, aVF, -aVR, Pleth, CPR, DE

Table 14-18 Settings Pacer - List View

In pacer mode the user OPERATOR can configure the second curve field and a vital parameter field.

**To configure the second curve field and one vital parameter field, proceed as follows:**

1. Hold down the key/softkey **Main menu** for three seconds.  
*The menu has been opened.*
2. Navigate to the menu item [Pacer] by pressing the softkey [Up] or "Down".  
*The menu item is marked in yellow.*
3. To select the menu item "Pacer", press softkey [OK].  
*The submenu item ► "Pacer" is open.*



To close the submenu, press softkey [Back] once or twice.

4. Select in the list box *Additional curve* and *VP* the required curves or vital parameters (refer to 13.4.1 Submenu item Curves on page 118) and (refer to 13.4.2 Submenu item Parameters on page 120).

*An additional curve field or vital parameter field are configured.*

5. To save the changed settings, the following options are available:
  - a) To save the settings, press softkey [Store].  
*The menu is closed. The settings will be stored until the user switches off the corpuls1.*
  - b) To retain the previous settings and close the menu, press the softkey [Cancel].  
*The menu is closed. The settings have not been stored.*

## 14.5 Menu item Telemetry

The menu item "Telemetry" allows to configure settings for the LAN interface.

### 14.5.1 Submenu item LAN

The submenu item ► "LAN" allows to adjust settings of the network configuration.

*To open the configuration dialogue, proceed as follows:*

1. In the menu "Telemetry" select ► "LAN".

*The configuration dialogue is open.*

*In the info area at the bottom, the MAC address and the IP address of the corpuls1 are displayed.*



---

If no IP address has been assigned, the corpuls1 shows the IP address 0.0.0.0.

---

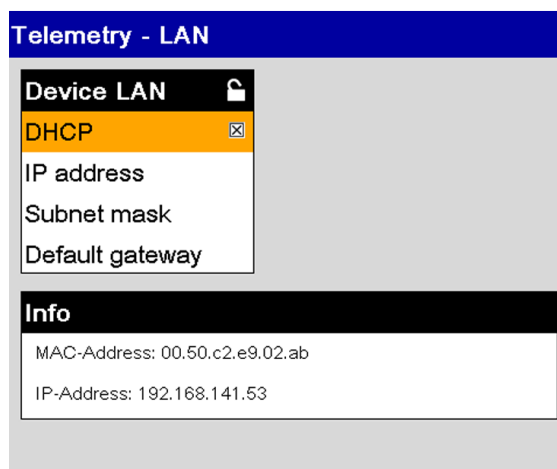

Figure 14-9 Settings LAN (user OPERATOR)

List  
Device LAN

List box	Description	Value
<i>DHCP</i>	Allows to adjust the type of network configuration. DHCP corresponds to an automatic network configuration. If the automatic network configuration is not enabled, the user OPERATOR has to adjust the network configuration manually.	<input checked="" type="checkbox"/> ; <input type="checkbox"/>
<i>IP address</i>	Allows to enter an IP address.	Numbers from 0 to 9; Dot .
<i>Subnet mask</i>	Allows to enter a subnet mask.	Numbers from 0 to 9; Dot .
<i>Default gateway</i>	Allows to enter a default gateway.	Numbers from 0 to 9; Dot .

Table 14-19 Settings LAN (user OPERATOR) - List LAN in device

If the network configuration has to be adjusted manually, the user OPERATOR has to enter an IP address, a subnet mask and a default gateway. The user OPERATOR can enter the subnet mask and the default gateway analogously.

Prerequisite:

- Checkbox at list box *DHCP* is deselected

**To change the IP address, proceed as follows:**

1. Navigate to the list box *IP address* by pressing the softkey [Up] or [Down].  
*The list box is marked in yellow.*
2. Press softkey [OK].  
*The IP address is visible.*



To abort the process, press softkey [Cancel].

3. Press softkey [Change].  
*The input window for entering data is open.*



Figure 14-10 Entering the IP address (user OPERATOR)

4. Enter IP address.



Entering values for *IP address* can be done in individual steps or with quick pass through (refer to 13.3.2 Submenu item Limits on page 114).

- By selecting the symbol < the user OPERATOR can delete the last entry.
5. Press softkey [Store].

The entry menu is closed. The IP address has been stored and is displayed in the info area at the bottom.

## 14.6 Menu Item System

The menu item "System" allows to open the mission administration, to configure system settings for the corpuls1, to display system information on the corpuls1, to log in at another user level and to update software/firmware.

### 14.6.1 Submenu item Settings

The submenu item ► "Settings" allows to configure system settings for the corpuls1.

*To open the system settings, proceed as follows:*

1. In the menu "System", select ► "Settings".

*The configuration dialogue is open.*

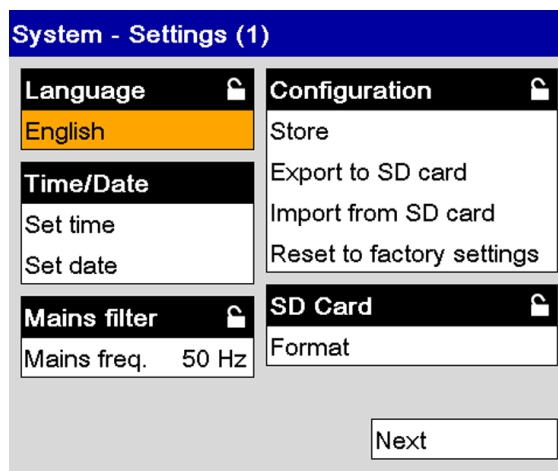

Figure 14-11 System settings (1) (user OPERATOR)

List  
Language

List box	Description	Values
Depending on the configured language	Allows to select the language of the user interface. The selection of available languages depends on which language pack is installed on the corpuls1.	e. g. English, German

Table 14-20 System settings (1) (user OPERATOR) - List Language

List  
Mains filter

List box	Description	Values
Mains freq.	Allows to adjust the frequency of the mains filter.	50 Hz, 60 Hz

Table 14-21 System settings (1) (user OPERATOR) - List Mains filter

List Configuration	List box	Description	Values
	<i>Store</i>	Allows to store the all settings permanently.	
	<i>Export to SD card</i>	Allows to export the all settings to the SD card. Excepted from export are the access codes for the user levels as well as the device-ID in the master data (in configuration dialogue System - Master data). The user OPERATOR can import the exported settings again or can transfer these to another corpuls1 via the import function.	
	<i>Import from SD card</i>	Allows to import settings from an SD card onto the device.  To import the settings, press the softkey [OK] when the list box <i>Import from SD card</i> is marked in yellow. After the message <b>Import from SD card successful</b> has disappeared, press softkey [Store] and switch off the corpuls1. The next time the user DEFAULT or MAN. DEFIB. switches on the corpuls1, the imported settings are active.	
	<i>Reset to factory settings</i>	Allows to reset the corpuls1 to factory settings (refer to K Reset to Factory Settings on page 246).  When the corpuls1 is reset to factory settings, all mission data that are not archived on the SD card will be deleted, except the data set of the current mission. The corpuls1 informs the user OPERATOR with the alarm "Deleting unarchived mission data".	

Table 14-22 System settings (1) (user OPERATOR) - List Configuration

**To store the complete configuration as set by the user OPERATOR, proceed as follows:**

1. In the configuration dialogue "System - Settings (1)", select in the list "Configuration" the list box ► "Store".
2. Press softkey [OK].

*The message **Configuration stored** appears.*

*All settings configured by the user OPERATOR have been stored and are available for the next start of the device.*

List SD card	List box	Description	Values
	<i>Format</i>	Allows to format the SD card.	

Table 14-23 System settings (1) (user OPERATOR) - List SD card



The list box *Next* allows to navigate to System settings (2).

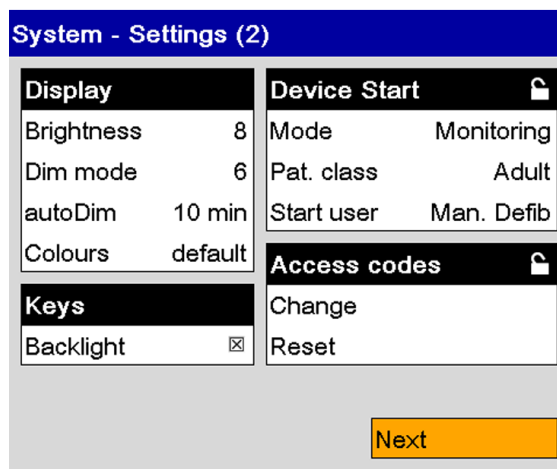

Figure 14-12 System settings (2) (user OPERATOR)



For a description of the settings of the lists *Display* and *Keys* see the relevant chapter for the user levels DEFAULT or MAN. DEFIB. (refer to 13.9.2 Submenu item Settings on page 133).

**List**  
*Device start*

List box	Description	Values
<i>Mode</i>	Allows to change the starting mode with which the corpuls1 is booting. Monitoring: The corpuls1 starts in monitoring mode. Defib: The corpuls1 starts in AED- or manual mode, depending on which defibrillation mode is configured (refer to 14.3.2 Submenu item Settings on page 143). NOTE: Starting in manual mode is only possible if user level MAN. DEFIB. is set as start user ( <i>Start user</i> ), because for user level DEFAULT, only the AED mode is intended.	Monitoring, Defib
<i>Patient class</i>	Allows to change the patient class/-group with which the corpuls1 is booting.	Adult, Child, Neonate
<i>Start user</i>	Allows to change the user level with which the corpuls1 is booting.	Default, Man. Defib.

Table 14-24 System settings (2) (user OPERATOR) - List Device Start

**List**  
*Access codes*

List box	Description	Values
<i>Change</i>	Allows to change the access codes for the user levels.	DEFAULT, MAN. DEFIB., OPERATOR

List box	Description	Values
<i>Reset</i>	Allows to reset the access codes for the user levels to factory settings.	DEFAULT, MAN. DEFIB., OPERATOR

Table 14-25 System settings (2) (user OPERATOR) - List Access codes

### 14.6.2 Submenu item Update

The submenu item ► "Update" allows the user OPERATOR to install software/firmware updates for the corpuls1. The software/firmware updates come from the manufacturer. They do not entail changes in user guidance or device behaviour.



Make sure that the update procedure will not be interrupted due to low battery charge. Check that the battery in the corpuls1 is adequately charged before starting the update procedure. The battery is adequately charged if the message "Battery low" is not displayed. Alternatively, connect the device to the mains power.

Prerequisite:

- User is logged in as user OPERATOR
- An SD card with a valid update package is inserted to the corpuls1
- The update package has to have a defined file name (Example: *C1\_2.0.X.pck*)
- The user OPERATOR has checked that the battery is adequately charged

**To update the software/firmware, proceed as follows:**

1. In the menu "System", select ► "Update".

*The update dialogue is open.*

*The corpuls1 is searching for an installable software package on the SD card.*

*The following user interface appears.*

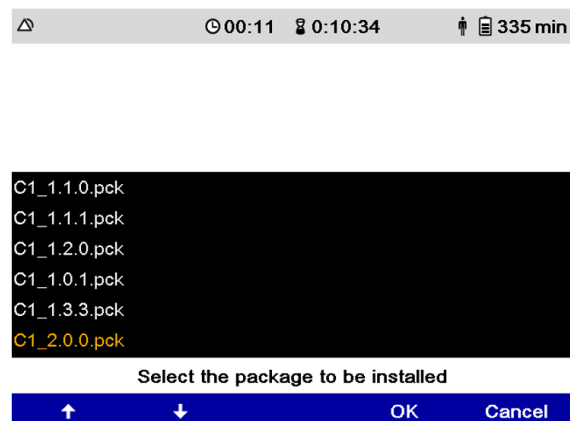

Figure 14-13 Update - Select the package to be installed (user OPERATOR)

*The message **Select the package to be installed** appears.*

2. Navigate to the required software package using the softkeys [Up] and [Down].

The system lists all software packages that are stored on the SD card and the user has to select.

- To select the required software package, press softkey [OK].

The system checks the version of the selected update package and the version of the installed software and shows both versions.

The following user interface appears.

The system shows the content of the currently installed package in the column "Current" and the contents of the selected package in the column "Update".

The versions of the currently installed software and of the update package to be installed may only differ in the last (third) number. The version of the update package to be installed has to be higher than that of the currently installed software. The versions of the other four entries (firmware) may not be lower than the currently installed software. These may also differ in the first and second number. The software package has to be complete. If one of these conditions is not met, the corpuls1 refuses to install the package.

	⌚ 23:32	🕒 00:46:51	📶 377 min
	Current	Update	
corpuls <sup>1</sup> (ApplSw)	C1_2.0.0	C1_2.0.0	
corpuls <sup>1</sup> (OS)	C1_2.0.0	C1_2.0.0	
corpuls <sup>1</sup> (Language)	C1_2.0.0	C1_2.0.0	
HV module (FW)	2.5	C1_2.5	
HV module (CPLD)	5	C1_5	
PIF module	1.45	C1_1.45	
ECG module	2.5	C1_2.5	
CPR module	0.4	C1_0.5	

Press OK to start update

OK	Cancel
----	--------

Figure 14-14 Update - selected file (user OPERATOR)

The message **Press OK to start update** appears.



If the user does not want to install this package, pressing the softkey [Cancel] goes back one step and another package can be selected.



If the user presses the softkey [OK], the system checks once again the installation rights. If the version number of the update package is older than the version installed, the corpuls1 aborts the update and the message **Update failed, check current software versions** appears.

- If the correct update package has been selected, press the softkey [OK].

Messages, as e. g. **Unpacking modules...**, **Suspending module operation...** and **Update in progress...** appear.

The corpuls1 indicates the progress of installing the individual software/firmware files. Successfully installed software/firmware components are represented by a green bar, the

*progress of software/firmware to be installed by a red bar.*

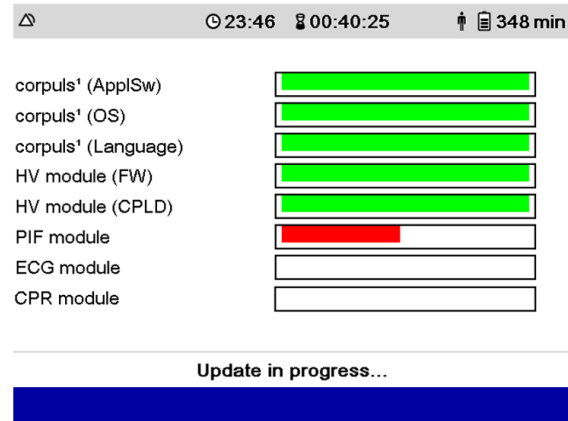

Figure 14-15 Update - Installation progress (user OPERATOR)

*The message **Rebooting system...** appears, followed by other messages, as e. g. **Collecting data...***

*After a successful update installation the corpuls1 represents all software/firmware components by at green bar.*



Do not abort this procedure, the user has to wait until the complete software/firmware package has been written on the corpuls1. If not, the respective module is not functional due to partially overwritten firmware and lack of backup.

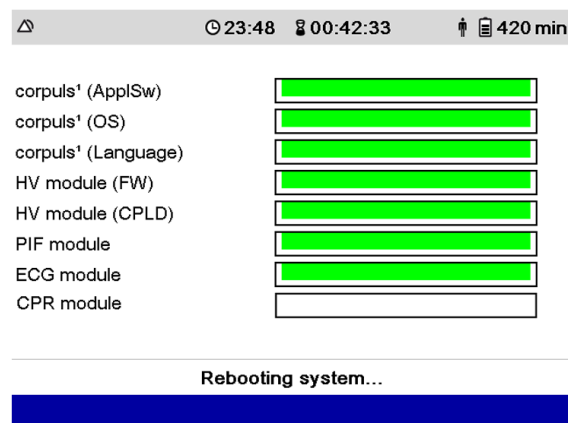

Figure 14-16 Update - Successful installation (user OPERATOR)



If the update installation is not successful, all faultily installed software/firmware components are represented by a red bar.

The message **Update failed, check current software versions** and the softkey [Again] appear.

The user OPERATOR has to start again the update with the softkey [Again]. The user is again at step 2 (Selection of the software/firmware package to be installed). Repeat all steps, until all installed software/firmware components are represented by a green bar.

If the corpuls1 could not install the software/firmware components correctly, contact your authorised sales and service partner.

*The corpuls1 restarts and the following user interface appears.*

△	⌚ 03:11	🕒 00:00:34	🔋 362 min
	Current		
corpuls <sup>1</sup> (ApplSw)	C1_2.0.0		
corpuls <sup>1</sup> (OS)	C1_2.0.0		
corpuls <sup>1</sup> (Language)	C1_2.0.0		
HV module (FW)	2.5		
HV module (CPLD)	5		
PIF module	1.45		
ECG module	2.5		
CPR module	0.4		

**Check software recently installed**

OK    Again

Figure 14-17 Update - Displaying current software/firmware version (user OPERATOR)

*The message **Check software recently installed** appears.*

5. After checking the software/firmware version, press softkey [OK].



If the corpuls1 could not start the new software version properly, the corpuls1 starts with the previous software version.

Start normal operation by pressing the softkey [OK].

*The message **Restore previous user settings?** appears.*

6. One of the two following options are available:

a) To restore the previous user settings, press softkey [Yes].

*Following the update by the user OPERATOR, the corpuls1 restores the previous customised settings.*

b) To *not* restore previous user settings, press softkey [No].

*Following the update by the user OPERATOR, the corpuls1 returns to factory settings.*



---

The previous user settings also include the access codes for the user levels DEFAULT, MAN. DEFIB., OPERATOR.

---

*The message **Please wait...** appears.*

*The message **Update completed, rebooting system...** appears.*

*The corpuls1 starts again in pre-configured startup mode.*

*The software/firmware update is complete and the start screen (in general the monitoring mode) appears.*

---



If the corpuls1 could not complete the software/firmware update correctly, contact your authorised sales and service partner.

---

7. Check the functionality of the corpuls1 by means of the daily functional test (refer to 15.3 Functional Test on page 166).
8. Make sure that the corpuls1 has restored previous user settings.

### 14.6.3 Submenu item Service

The user can set dates for the following service points:

- Next technical safety check
- Next maintenance
- Next battery change

When the scheduled appointments have been reached, the user receives a corresponding service message when switching off the corpuls1 (refer to 16 Service Events on page 178).

---



When setting the dates, mind the intervals for technical safety checks, maintenance etc. (refer to 15.2 Test- and Maintenance Intervals on page 166).

---

***To enter service dates, proceed as follows:***

1. In the menu "System", select ► "Service".

*The configuration dialogue is open.*

*The list box Next technical safety check is marked in yellow.*

System - Service	
Next safety check	06 / 2017
Next maintenance	10 / 2017
Battery exchange	12 / 2018

Figure 14-18 Service entry (user OPERATOR only)

2. Press softkey [OK].  
*The list box Next technical safety check is marked in yellow.*
3. Enter month value.  
Navigate to the required value by pressing the softkey [Up] or [Down] and confirm with softkey [OK].



The user can navigate to the required value by using individual steps or the quick pass through (refer to 13.3.2 Submenu item Limits on page 114).

*The selected monthly value is set and the year is marked in yellow.*

4. Enter year value.  
Navigate to the required value by pressing the softkey [Up] or [Down] and confirm with softkey [OK].  
*The selected year value is set and the list box Next technical safety check again is marked in yellow.*
5. Navigate to the list box *Next maintenance* by pressing the softkey [Down].  
*The list box Next maintenance is marked in yellow.*
6. For all further service data configurations, proceed as described in steps 3 to 5.
7. Save all entered service data configurations with the softkey [Save] in "System-Settings (1)" (refer to 14.6.1 Submenu item Settings on page 153).



For year entries that are in the past, the corpuls1 marks the value in red.

List box	Description	Values
<i>Next technical safety check</i>	Date of the next technical safety check	Month (M) and year (Y), in format MM:YYYY
<i>Next maintenance</i>	Date of the next maintenance.	Month (M) and year (Y), in format MM:YYYY
<i>Battery exchange</i>	Date of the next battery change	Month (M) and year (Y), in format MM:YYYY

Table 14-26 Service entries (user OPERATOR) - List service

#### 14.6.4 Submenu item Login

The user OPERATOR can log in to the corpuls1 at various user levels.



#### WARNING!

##### Missing access code for manual defibrillation mode!

Can prevent the treatment of patients with an implanted pacer in AED mode.

- Make sure that the access code for the manual mode is made available to authorised users.

The following table gives an overview of the user levels, the access codes set as default and the authorisation levels.

User level	Access code	Authorisation
DEFAULT	1111	Allows to change the settings for the user level DEFAULT. No access to the manual defibrillation mode.
MAN. DEFIB.	2222	Allows to change the settings for the user level MAN. DEFIB. Access to the manual defibrillation mode.
OPERATOR	3333	Allows to change the settings for the user level DEFAULT, MAN. DEFIB. and OPERATOR. Access to the manual defibrillation mode.

Table 14-27 Access codes for the user levels



The operator should change the access code for the user level OPERATOR before handing out the devices to users. So the operator keeps control over all access codes.

##### *To log in a user, proceed as follows:*

1. In the menu "System", select ► "Login".

*The input window for entering data is open.*



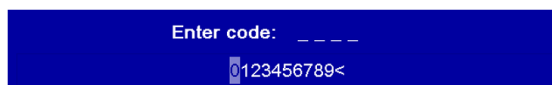

Figure 14-19 Entering the access code

2. Enter the 4-digit access code.



To obtain the access code for a user level, contact the operator.

By selecting the symbol < the user OPERATOR can delete the last entry.

*The message **User [XY] logged in successfully** appears. User is logged in.*

### 14.6.5 Submenu item Mission

#### Demo mode

The user OPERATOR can activate the demo mode for training purposes. The demo mode shows simulated curves and vital parameters, the derivations of therapy electrodes (ECG lead DE and vital parameter HR) shows measured values. The demo mode allows a demonstration of all functions and possible configurations. In the defibrillation modes the analysis function (only AED mode) and shock release is active, in pacer mode stimulation current release is active.



#### WARNING!

#### Electric shock when used in demo mode!

Can lead to the following side effects in patients, users and third parties: arrhythmias, ventricular fibrillation or asystole.

- ▶ Take all countermeasures as described in the safety notes pertaining to therapy in defibrillation mode and pacer mode.
- ▶ The use of the demo mode during patient care is strictly forbidden.
- ▶ Only use the demo mode for training purposes.
- ▶ If the corpuls1 is currently in demo mode and should be used for patient care, the device has to be restarted first.

*To enable the demo mode, proceed as follows:*

1. In the menu "System", select ▶ "Mission".

*The mission administration is open and allows to enable the demo mode.*

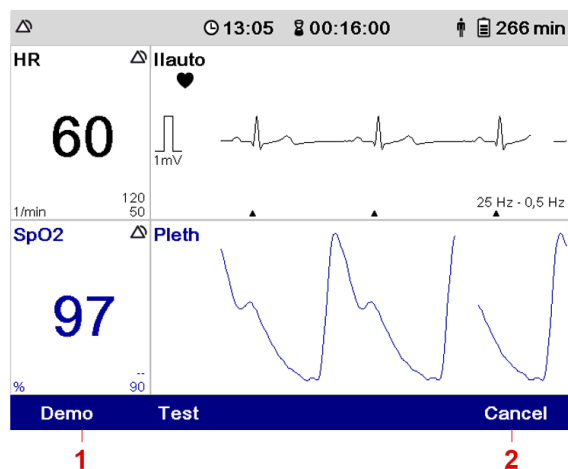

Figure 14-20 Activating the demo mode

- 1 Softkey [Demo]
- 2 Softkey [Cancel]



---

To close the mission administration, press softkey [Cancel].

---

2. Press softkey [Demo].  
*The confirmation prompt **Start demo mode?** appears.*
3. Press softkey [OK].  
*The message **Demo mode on** appears in the message line.*  
*The corpuls1 shows curves and parameters from the internal memory.*



---

To leave the demo mode, press softkey [Cancel].

---



---

To disable the demo mode, switch off the corpuls1 with the On/Off key.

---

## 15 Functional Test and Maintenance

---

The regular function check and maintenance of the corpuls1 guarantees unlimited functional readiness, prevents electrical or mechanical malfunctions and indicates errors promptly.

### 15.1 Warnings

The following warnings inform the user of possible hazards when using the corpuls1.



#### WARNING!

##### Malfunctions of the device!

Can result in functions of the corpuls1 no longer working properly.

- ▶ If users cannot eliminate malfunctions by themselves, contact an authorised sales and service partner.
  - ▶ If necessary, stop using the corpuls1.
- 



#### WARNING!

##### Device not ready for operation due to no function test and no maintenance!

Can result in functions of the corpuls1 no longer working properly.

- ▶ Always follow the schedule for function test (refer to 15.2 Test- and Maintenance Intervals on page 166) and maintenance (see corpuls1), regardless of whether the is only used rarely or is stored for long periods.
  - ▶ Do not use the corpuls1 if a scheduled maintenance (refer to 15.5 Regular Maintenance Work on page 172) has not been performed.
  - ▶ Make sure that function checks, services and regular inspections are always performed according to schedule.
  - ▶ The corpuls1 and the battery must be stored only under approved storage conditions. Temperature and humidity are very important. See the "Technical data" for the applicable values (refer to H Technical Specifications on page 220).
  - ▶ The storage requirements for the therapy electrodes like e. g. corPatch easy and the sensors, like e. g. corPatch CPR disposable sensor are described on the packaging of these accessories.
  - ▶ If necessary, stop using the corpuls1.
  - ▶ Regarding electromagnetic interference, no maintenance is required during the life of the device.
-

**WARNING!****Electric shock!**

A damaged connection cable of the test box (P/N 04310) or the corpuls simulator (P/N 04311) can cause an electric shock and can lead to the following side effects in patients, users and third parties: arrhythmias, ventricular fibrillation or asystole.

- ▶ Before using the testbox or the corpuls simulator check the cable for damage.
- ▶ If there is damage of the connection cable, the testbox or the corpuls simulator may not be used under any circumstances.

## 15.2 Test- and Maintenance Intervals

The following table gives an overview of the intervals at which to perform checks and maintenance measures.

Measure	Daily/ per shift*	After use**	As neces- sary**	Monthly	Every 2 years	If faulty
Visual check	x	x	x			x
Basic functional test	x	x	x			x
Extended functional test		x	x	x		x
Cleaning/Disinfection		x	x			
Shock paddles	x		x	x		
Safety-related check (SC)					x	x

Table 15-1 Checking and maintenance intervals

Including first commissioning

\*\*Manufacturer's recommendation

## 15.3 Functional Test

The function test checks the functions of the corpuls1.

The function test of the corpuls1 includes visual inspection of the exterior for any deficiencies and checks that all components are complete and also performs a function test of the corpuls1.

The function check of the power supply informs the user about the current state of charge of the batteries.

The function test of the accessories and consumable materials ensures that all materials that the user of the corpuls1 requires are present and functional.

If no correct result is achieved on performing the function checks, read the explanations and measures given for alarms and messages (refer to 17 Alarms and Messages on page 180).

The function check of the corpuls1 consists of:

- Visual check
- Basic functional test
- Extended functional test

For the daily visual check and the daily functional test a checklist is available (refer to L Checklist Functional test on page 251).

**Visual check** For the visual inspection of the corpuls1 and the accessory note the following:

Presence and serviceability of	Measure	Correct result
Check corPatch easy electrodes including the therapy master cable (if available).	A Inspect therapy master cable for damage.	Therapy master cable is undamaged.
	B Check the expiry date on the package of the corPatch easy electrodes.	The expiry date of the corPatch easy electrodes has not yet passed.
	C Check the package of the corPatch easy electrodes for damage.	The package of the corPatch easy electrodes is not damaged.
	D Check if additional corPatch easy electrodes are present as replacement.	Additional therapy electrodes are present.
Check shock paddles and therapy master cable (if present).	A Inspect therapy master cable for damage.	Therapy master cable is undamaged.
	B Press the shock paddle buttons a few times to ensure perfect functionality.	The shock paddle buttons generate an audible confirmation tone.
Check baby shock electrodes (if present).	A Check baby shock electrodes for cleanliness and damage.	Baby shock electrodes are clean and undamaged.
Electrode gel for defibrillation (when using shock paddles)	A Estimate if the quantity of electrode gel is sufficient for the next mission.	Sufficient electrode gel for the next mission incl. replacement tube is present.
Check shock spoons (if present).	A Functional test, as described in the Shock spoon manual (P/N: 04137).	As described in the Shock spoon manual (P/N: 04137).
Check oximetry sensors incl. intermediate cable (if present).	A Check intermediate cable for damage.	Oximetry sensors and intermediate cable are undamaged.
	B Check oximetry sensors for damage.	

Presence and serviceability of	Measure	Correct result
Check ECG monitoring cable including ECG electrodes.	A Check ECG monitoring cable for damage. B Check ECG electrodes for damage. C Hold sufficient amount of ECG electrodes. D Check the expiry date on the ECG electrodes.	ECG monitoring cable and ECG electrodes are undamaged.
Check corPatch CPR disposable sensor including CPR intermediate cable present (if present)	A Check intermediate cable for damage.	The intermediate cable is undamaged.
	B Check the expiry date on the corPatch CPR disposable sensor.	The expiry date of the corPatch CPR disposable sensor has not yet passed.
	C Check the expiry date on the corPatch CPR disposable sensors for damage.	Packaging of the corPatch CPR disposable sensor is undamaged.
	D Check if additional corPatch CPR disposable sensor is available as replacement.	Additional sensors are present.
SD Card	A Check if a SD card is inserted in the corpuls1.	SD card is inserted in the corpuls1.
Check Testbox (P/N 04310) or corpuls simulator (P/N 04311).	Check the cable of the Testbox or of the corpuls simulator for damage.	Cable of the Testbox or the corpuls simulator is not damaged.

Table 15-2 Visual check of the corpuls1

**Basic functional test**

The daily basic functional check consists of the following steps:

Purpose	Measure	Correct result
Switch on the corpuls1.		
Start functional test	Press the On/Off key.	The start logo appears.

Self test switch on		
Checking system components.	None.	The screen is illuminated.
		The screen displays curves and vital parameter fields.
		The screen displays the remaining running time or the charging status of the battery. The battery is sufficiently charged.
		The alarm history shows no alarms.
Check shock paddles and therapy master cable (if present).		
Check shock paddles and therapy master cable for functionality.	A Press the shock paddle buttons a few times to ensure perfect functionality.	The shock paddle buttons generate an audible confirmation tone.
	B Deliver a shock (see functional test Defibrillator/Pacer)	No error message appears.
Defibrillator/pacer		
Check the defibrillator/pacer functionality.	<p>Use functional Testload (P/N 04312)/ Testbox (P/N 04310)/corpuls simulator (P/N 04311). For commissioning and de-commissioning of the Testload/ Testbox/ corpuls simulator see the user manual Testload/ Testbox/ corpuls simulator.</p> <p>A Select the manual mode of the corpuls1.</p> <p>B Select a shock energy of 200 J (recommendation of manufacturer: 50 J) and charge.</p> <p>C Releasing a shock.</p>	<p>The corpuls1 recognises patient impedance correctly.</p> <p>The corpuls1 does not signal any error messages.</p>
Battery		
Checking the charging status of the battery.	<p>A Connect the corpuls1 to a power supply.</p> <p>B Checking the charging status of the battery.</p>	<p>Charging status of the battery &gt; 30 %.</p> <p>At temperatures below the freezing point, the battery charging status has to be &gt; 50 %.</p>
Switch off the corpuls1.		
Concluding the function test.	A Switch off the corpuls1.	The corpuls1 is switched off.

**Extended functional test** The extended monthly functional check consists of the following steps:

Purpose	Measure	Correct result
Switch on the corpuls1.		
Start functional test	See Basic functional test	See Basic functional test
Self test switch on		
Checking system components.	See Basic functional test	See Basic functional test
Check shock paddles and therapy master cable (if present).		
Check shock paddles and therapy master cable for functionality.	See Basic functional test	See Basic functional test
Defibrillator/pacer		
Check the defibrillator/pacer functionality.	See Basic functional test	See Basic functional test
ECG Monitoring		
Check ECG monitoring functionality and ECG monitoring cable.	Use functional Testbox (P/N 04310) or corpuls simulator (P/N 04311). For commissioning and decommissioning of the Testbox or the corpuls simulator see the user manual Testbox/corpuls simulator. A For optimal results, select an amplification of x0.5. B If a ECG curve is not displayed, check the configuration. If necessary, select the parameter or curve field in which the value should be shown.	Curve fields and vital parameter fields display the ECG and vital parameters continuously and without artifacts.
Pulse oximetry monitoring		
Check pulse oximetry monitoring functionality and pulse oximetry sensor.	A Attach the pulse oximetry sensor with the intermediate cable to the patient. B If the oximetry values PR, PI, SPO <sub>2</sub> , SPCO®, SpHb®, SpMet® or the plethysmogram are not displayed, check the configuration. If necessary, select the parameter or curve field in which the value should be shown.	Curve fields and vital parameter fields display the plethysmogram and vital parameters continuously and without artifacts.



corPatch CPR Monitoring		
Check corPatch CPR disposable sensors for functionality.	<p>A Select manual mode.</p> <p>B Connect the corPatch CPR disposable sensor to the corPatch CPR intermediate cable.</p> <p>C Move the corPatch CPR disposable sensor up and down, approx. at compression rate.</p> <p>D If the CPR rate or -curve is not displayed, check the configuration. If necessary, select the parameter or curve field in which the value should be shown.</p>	Curve fields and vital parameter fields display the CPR curve and the CPR rate continuously and without artifacts.
SD card		
Check SD card.	A Check if the SD card is inserted.	SD card is inserted.
Alarm system		
Check visual and auditory alarm signals for functionality.	<p>A Connects sensors for the parameter to be checked.</p> <p>B Change upper or lower alarm limits to provoke an alarm.</p>	Visual and auditory alarm signals are issued.
Switch off the corpuls1.		
Conclude functional test.	See Basic functional test	See Basic functional test

## 15.4 Selftest

The corpuls1 performs a functional test in different operating states.

### 15.4.1 Self Test Switch on

When the user switches on the corpuls1, the corpuls1 performs a self-test switch on. The self-test switch on checks the battery and the internal memory as well as further system components.

If errors occur, the alarm history shows these errors.

### 15.4.2 Automatic Self-test

When the corpuls1 is switched off, the corpuls1 performs an automatic self-test. The automatic self-test checks at regular intervals the battery and the internal memory.

If no errors occur, the LED Operating status flashes up green at regular intervals. If errors occur, the LED Operating status is off. When the user switches on the corpuls1, the alarm history shows these errors.

## 15.5 Regular Maintenance Work

Maintenance works are to be performed exclusively by authorised sales and service partners. Maintenance work performed by non-authorised sales and service personnel can result in damage to the corpuls<sup>1</sup> and loss of warranty claims at GS Elektromedizinische Geräte G. Stemple GmbH.

### 15.5.1 Technical Safety Check

The intervals of the technical safety checks can be found in the overview Checking and maintenance intervals (refer to 15.2 Test- and Maintenance Intervals on page 166). Pursuant to MP-BetreibV (German ordinance for operators of medical devices), operators have to make sure that technical safety checks are performed regularly on their devices. In countries outside Germany, the corresponding nationally applicable laws have to be observed.

### 15.5.2 Repair and Service

To avoid transport damage when shipping the corpuls<sup>1</sup>, use the original packaging. If the original packaging is no longer available, use appropriate packaging. The packaging has to guarantee safe transport of the corpuls<sup>1</sup>. A packaging instruction is available from the manufacturer upon request.



#### WARNING!

##### Electric shock due to defibrillation!

Can lead to arrhythmias, ventricular fibrillation or asystole.

- ▶ Read the information on using the corpuls<sup>1</sup> in the user manual.
- ▶ Do not open the corpuls<sup>1</sup>.
- ▶ If a defect of the corpuls<sup>1</sup> is suspected, contact authorised sales and service partner.

## 15.6 Cleaning and Disinfection

Regular cleaning and disinfection allows the user to hygienically prepare the corpuls<sup>1</sup> and its accessories for the next use.

The following instructions have been validated by the manufacturer. The operator/person performing reprocessing is responsible for achieving the required result. This necessitates validation and routine supervision of the reprocessing process. Parallel to this validation and supervision, mind differing reprocessing instructions as well.

Checklist:

- Clean and disinfect the defibrillator and the accessories until all visible and invisible contamination has been removed.
- Check if all visible dirt has been removed.
- Exclusively clean and disinfect components that are intended to be re-used (device and accessories).
- After cleaning or disinfection, check the functionality of the defibrillator with the acces-

sories.

### 15.6.1 Recommended Cleaning- and Disinfecting Agents

The following disinfectants of PAUL HARTMANN AG (Bode Chemie) have been tested by the manufacturer and are recommended for effectiveness and material compatibility:

Disinfectants	Active ingredients	CAS No.	Max. application concentration % (m/m)
<b>Mikrobac® Virucidal Tissues</b>	Quaternary ammonium compounds	7173-51-5	0.25
		68391-01-5	0.25
	Aminoalcohols	141-43-5	1
<b>Bacillo® 30 Foam</b>	Alcohols	71-23-8	10
		67-63-0	20
		64-17-5	20
	Surfactant	139734-65-9	1
<b>Dismozon® plus</b>	Peroxide	84665-66-7	100
	Fatty alcohol	69011-36-5	2.5
	Amine	308062-28-4	2.5
<b>Kohrsolin® FF</b>	Aldehyde	111-30-8	10
	Surfactants	69011-36-5	10
		68439-50-9	10
	Quaternary ammonium compounds	7173-51-5	5
		68391-01-5	5
	Alcohol	67-63-0	3
<b>Mikrobac® Forte</b>	Quaternary ammonium compound	68391-01-5	20
	Amine	2372-82-9	5
	Surfactants	69011-36-5	3
		68439-50-9	2.5

Table 15-3 Overview of recommended disinfectants



When using other disinfectants, make sure those belong to the same group of active substances.

### 15.6.2 Warnings

The following warnings inform the user of possible hazards when using the corpuls1.

**WARNING!****Electric shock during cleaning and disinfection!**

Can lead to arrhythmias, ventricular fibrillation or asystole.

- ▶ Switch off and disconnect from power the corpuls1 supply before cleaning the corpuls1.

**NOTICE!****Wrong cleaning and disinfection!**

Can damage the material of the corpuls1 and accessories, impair their functions or cancel out the cleaning/disinfecting effect of substances.

- ▶ To remove all residue of cleaning- or disinfecting agents, wipe down with clear water the device after the contact time of the cleaning- or disinfecting agent has passed. Make sure the disinfection substance stays on the surface for the specified contact time according to the manufacturer's instructions.
- ▶ To remove dirt or stains use clean cloths or soft brushes exclusively.
- ▶ Only use cleaning- and disinfecting agents recommended by the manufacturer or other cleaning and disinfecting agents with equivalent substance groups, to avoid damage and impaired function. Read the application instructions of the manufacturer of the cleaning and disinfecting agents.
- ▶ Do not mix different cleaning or disinfecting liquids, because there can be interactions between the substances that cancel out their effects. Rinse with clear water between the application of different cleaning or disinfecting liquids.
- ▶ Follow instructions from the manufacturer of the cleaning and disinfecting agents that vary from this instruction.
- ▶ corpuls1 and only surface-treat accessories. Do not immerse into cleaning or disinfection fluid.
- ▶ Do not let fluids penetrate into the plug connections.
- ▶ corpuls1 and do not clean, disinfect or sterilise accessories by machine.

### 15.6.3 Cleaning and Disinfecting the Device

Cleaning and disinfection of the corpuls1 is recommended after use and according to need.

Prerequisite:

- The corpuls1 is disconnected from power supply
- Cables are disconnected from the corpuls1

*To clean and disinfect the corpuls1, proceed as follows:*

1. Wipe surfaces with appropriate cleaning agent and allow to dry.
2. Disinfect surfaces with a suitable disinfectant.
3. Allow disinfected surfaces to dry.
4. To remove any disinfectant residues, wipe the corpuls1 with a soft cloth soaked in clean water and then allow to dry.



If the two MagCode female/male metal contacts in the contact field are oxidised (black), the corpuls1 can no longer be charged with the power supply. Clean the contact fields of the Mag-Code connectors (at the charging brackets, the AC adapter cable or at the DC connector cable) with a glass fibre brush.

#### 15.6.4 Cleaning and Disinfecting the Charging Bracket (Accessories)

Cleaning and disinfection of the accessories is recommended after use and according to need.

Prerequisite:

- The charging bracket is disconnected from the power supply
- Mains cable is disconnected from charging bracket

*To clean and disinfect the charging bracket, proceed as follows:*

1. Wipe surfaces with appropriate cleaning agent and allow to dry.
2. Clean the mains cable with soap solution.
3. Let surfaces and plug connections dry.
4. Disinfect the mains cable with an appropriate disinfectant.
5. Allow disinfected surfaces to dry.
6. To remove any disinfectant residues, wipe the corpuls1 with a soft cloth soaked in clean water and then allow to dry.

#### 15.6.5 Cleaning and Disinfecting the Pulse Oximetry Sensor (Accessories)

Cleaning and disinfection of the accessories is recommended after use and according to need.

*To clean and disinfect the pulse oximetry sensor, proceed as follows:*

1. Clean the pulse oximetry intermediate cable with soap solution.
2. Let surfaces and plug connections dry.
3. Disinfect the pulse oximetry sensor with an appropriate disinfection substance.
4. Allow disinfected surfaces to dry.
5. To remove any disinfectant residues, wipe the corpuls1 with a soft cloth soaked in clean water and then allow to dry.

#### 15.6.6 Cleaning and Disinfecting the ECG Monitoring Cable (Accessories)

Cleaning and disinfection of the accessories is recommended after use and according to need.

*To clean and disinfect the ECG monitoring cable, proceed as follows:*

1. Clean the ECG monitoring cable with soap solution.
2. Let surfaces and plug connections dry.
3. Disinfect the ECG monitoring cable with an appropriate disinfection substance.
4. Allow disinfected surfaces to dry.
5. To remove any disinfectant residues, wipe the corpuls1 with a soft cloth soaked in clean water and then allow to dry.

### 15.6.7 Cleaning and Disinfecting the Accessory Bags and Front Cover (Accessories)

Cleaning and disinfection of the accessories is recommended after use and according to need.

*To clean and disinfect the accessory bags and the front cover, proceed as follows:*

1. Remove dirt with a brush.
2. Wipe down plastics surfaces.
3. Let surfaces dry.
4. Disinfect the cables with an appropriate disinfection substance.
5. Allow disinfected surfaces to dry.
6. If necessary, treat the zippers with dry-film lubricant (silicone spray).
7. To remove any disinfectant residues, wipe the corpuls1 with a soft cloth soaked in clean water and then allow to dry.

### 15.6.8 Cleaning and Disinfecting Shock Paddles (Accessories)

Cleaning and disinfection of the accessories is recommended after use and according to need.

*To clean and disinfect the shock paddles, proceed as follows:*

1. Clean the cable, shock paddle handles and the electrode surfaces with soap solution.
2. Let surfaces and plug connections dry.



---

Make sure that no residual electrode gel remains on the electrode plates or between the electrode plates and the paddle handles.

---



---

Make sure that the electrode surface is not scratched.

---

3. Disinfect the electrode plates of the shock paddles with an appropriate disinfectant.
4. Allow disinfected surfaces to dry.
5. To remove any disinfectant residues, wipe the corpuls1 with a soft cloth soaked in clean water and then allow to dry.

### 15.6.9 Cleaning and Disinfecting Baby Shock Electrodes (Accessories)

Cleaning and disinfection of the accessories is recommended after use and according to need.

*To clean and disinfect the baby shock electrodes, proceed as follows:*

1. Clean the cable and the electrode surfaces with soap solution.
2. Let surfaces and plug connections dry.



---

Make sure that no residual electrode gel remains.

---



---

Make sure that the electrode surface is not scratched.

---

3. keep contact springs clean.
4. Disinfect the electrode plates of the baby shock electrodes with an appropriate disinfectant.
5. Allow disinfected surfaces to dry.
6. To remove any disinfectant residues, wipe the corpuls1 with a soft cloth soaked in clean water and then allow to dry.

### 15.6.10 Cleaning and Disinfecting the Therapy Master Cable (Accessories)

Cleaning and disinfection of the accessories is recommended after use and according to need.

*To clean and disinfect the therapy master cable, proceed as follows:*

1. Clean the therapy master cable with soap solution.
2. Let surfaces and plug connections dry.
3. Disinfect the therapy master cable with an appropriate disinfectant.
4. Allow disinfected surfaces to dry.
5. To remove any disinfectant residues, wipe the corpuls1 with a soft cloth soaked in clean water and then allow to dry.

### 15.6.11 Cleaning and Disinfecting the corPatch CPR Intermediate Cable (Accessories)

Cleaning and disinfection of the accessories is recommended after use and according to need.

*To clean and disinfect the corPatch CPR intermediate cable, proceed as follows:*

1. Clean the CPR intermediate cable with soap solution.
2. Let surfaces and plug connections dry.
3. Disinfect the CPR intermediate cable with an appropriate disinfection substance.
4. Allow disinfected surfaces to dry.
5. To remove any disinfectant residues, wipe the corpuls1 with a soft cloth soaked in clean water and then allow to dry.

## 16 Service Events

The corpuls<sup>1</sup> reminds the user of service events that the user or a service technician have to remedy. The user has to confirm these service events when switching off the corpuls<sup>1</sup>.

The following table describes service events, their causes and measures to take.

Service events can have different causes. Different causes are labelled with letters in the "Cause" column.

The user can remedy service events by taking specific measures. Different measures are labelled with letters in the "Measure" column. The user must carry out the measures one by one from A to Z until one of the measures proves successful in remedying the service event.

Service Event	Cause	Measure
<b>Planned battery change due</b> NOTE: (refer to 14.6.3 Submenu item Service on page 160)	A Battery capacity < 50 %.	A Change battery and dispose of old battery.
<b>Service checkup due</b> NOTE: (refer to 14.6.3 Submenu item Service on page 160)	A Service checkup is due.	A Contact your sales and service partner.
<b>Safety checkup due</b> NOTE: (refer to 14.6.3 Submenu item Service on page 160)	A Safety checkup is due.	A Contact your sales and service partner.
<b>Therapy electrode reported error</b>	A No original accessories were used. B Error in the therapy electrode module.	A Use original accessories. B Contact your sales and service partner.
<b>Defibrillator reported error</b>	A Error in the defibrillator module.  NOTE: In corpuls <sup>1</sup> devices with the Pacer option this service events means that also the pacer is not available.	A Remove the therapy electrode from the corpuls <sup>1</sup> and re-connect. B Contact your sales and service partner.
<b>ECG reported error</b>	A Error in the ECG module.	A Contact your sales and service partner.
<b>ECG-Module not detected</b>	A ECG module not available. B An ECG module is available and there is an error in the ECG module.	A If no ECG module available, no action required. B Contact your sales and service partner.



Service Event	Cause	Measure
<b>Oxi failure</b>	A Error in the oximetry module.	A Remove the sensor from the corpuls1 and re-connect. B Contact your sales and service partner.
<b>Error CPR module</b>	A Error in the CPR module.	A Remove the sensor from the corpuls1 and re-connect. B Contact your sales and service partner.
<b>HV unit selftest error</b>	A Error in the HV module or defibrillator module.	A Contact your sales and service partner.
<b>ECG module selftest error</b>	A Error in the ECG module.	A Contact your sales and service partner.
<b>Oxi sensor or oxi cable near expiration</b>	A The oximetry sensor or oximetry cable will soon expire.	A Replace the oximetry sensor or oximetry cable. B Contact your sales and service partner.

Table 16-1 Service Events

## 17 Alarms and Messages

---

Alarms signal malfunctions or abnormal performance of the corpuls<sup>1</sup> to the user or inform the user about a critical health condition of the patient.

Messages are either instructions to the user or give the user further information concerning alarms.

### 17.1 Warnings

The following warnings inform the user of possible hazards when using the corpuls<sup>1</sup>.



#### WARNING!

##### **Not eliminating alarms of high (!!!), medium (!! ) and low (!) priority!**

If alarms with a high priority are not eliminated, this can lead to death, irreversible or reversible injuries of users, patients or third parties.

If alarms with a medium priority are not eliminated, this can lead to death, irreversible or reversible injuries, minor injuries or discomfort of users, patients or third parties.

If alarms with a low priority are not eliminated, this can lead to reversible injuries, minor injuries or discomfort of users, patients or third parties.

- ▶ Eliminate alarms immediately after they are signalled.



If no oximetry (SP02) vital parameters or no oximetry (SP02) curve are displayed and the pulse oximetry sensor and all cables are connected correctly, check if the combination of pulse oximetry sensor and intermediate cable are compatible. The pulse oximetry sensor M-LNCS needs a 15-pole intermediate cable.

---

## 17.2 Alarm List

The following table gives an overview of alarms that can occur during operation.

Alarms can have different causes that are labelled with letters in the *Cause* column.

The user can remedy alarms by taking specific measures. Different measures are labelled with letters in the *Measure* column. The user must carry out the measures one by one from A to Z until one of the measures proves successful in remedying the alarm.

Alarm text	Type of alarm	Priority	Cause	Measure
"Battery low"	System	High	A Remaining battery charge < 20 %.	A Charge the battery.
"Check plug therapy cable"	System	High	A The therapy electrodes are not connected correctly to the therapy master cable.	A Connect the therapy electrodes correctly to the therapy master cable. B Check the plugs of the therapy master cable and therapy electrodes for damage. C Take the corpuls1 out of commission. D Contact your sales and service partner.
"CPR cable loose"	System	Medium	The cable indicated is not connected to the corpuls1.	A Check the respective cable and reconnect if necessary.
"CPR failure (1)"	System	Medium	Internal data processing error (Buffer overflow).	--
"CPR sensor expired"	System	Medium	The sensor is expired and has to be exchanged with a new one.	A Replace the sensor.
"CPR sensor loose"	System	Medium	The sensor indicated has come loose from the intermediate cable.	A Check the sensor and reconnect if necessary.
"Database initialisation error"	System	High	A Initialisation of internal memory failed.	A Contact your sales and service partner.
"Def. Oxi adhes. sensor"	System	Medium	A The pulse oximetry adhesive sensor is defective or has expired.	A Dispose of the old pulse oximetry adhesive sensor and use a new pulse oximetry adhesive sensor.
"Defective Oxi cable"	System	Medium	A The pulse oximetry intermediate cable is not connected properly to the corpuls1. B The pulse oximetry intermediate cable is defective.	A Disconnect the pulse oximetry intermediate cable from the corpuls1 and re-connect. B If the LED of the pulse oximetry sensor does not flash, the pulse oximetry intermediate cable has to be exchanged.

Alarm text	Type of alarm	Priority	Cause	Measure
"Defective Oxi sensor"	System	Medium	<p>A The pulse oximetry sensor cable is not or not properly connected to the pulse oximetry intermediate cable.</p> <p>B The pulse oximetry sensor is defective.</p>	<p>A Disconnect the pulse oximetry sensor cable from the pulse oximetry intermediate cable and connect again.</p> <p>B If the LED of the pulse oximetry sensor does not flash, the pulse oximetry sensor has to be exchanged.</p>
"Defibrillator alarm (x)"	System	High	<p>An alarm occurred in the defibrillator. The "X" is a placeholder for a specified number of the alarm.</p> <p>A Defibrillator does not function correctly.</p>	<p>A Do not use defibrillator on patients.</p> <p>B Contact your sales and service partner.</p>
"Defibrillator failure (x)"	System	High	<p>An error occurred in the defibrillator. The "X" is a placeholder for a specified number of the alarm.</p> <p>A Defibrillator does not function correctly.</p>	<p>A Do not use defibrillator on patients.</p> <p>B Contact your sales and service partner.</p>
"Deleting unarchived mission data"	System	Low	<p>A Mission data not yet stored on the SD card have been deleted from the device's internal memory.</p>	-
"Device overheated, defibrillator is not available"	System	High	<p>A The temperature of the corpuls1 is elevated. The corpuls1 is possibly exposed to too high temperatures.</p>	<p>A Interrupt the charging process of the battery.</p> <p>B Let the corpuls1 cool down.</p>
"Device overheated, device switching off"	System	High	<p>A The temperature of the corpuls1 is elevated. The corpuls1 is possibly exposed to too high temperatures.</p>	<p>A After the user switches off the corpuls1 and before the corpuls1 is switched on again, leave to cool down.</p>
"Device selftest internal memory failure"	System	High	<p>A An error occurred during the selftest of the device's internal memory.</p>	<p>A Contact your sales and service partner.</p>
"Device temperature high"	System	Medium	<p>A The temperature of the corpuls1 is elevated. The corpuls1 is possibly exposed to too high temperatures.</p>	<p>A Interrupt the charging process of the battery.</p> <p>B Let the corpuls1 cool down.</p>
"Device temperature sensor failure"	System	Medium	<p>A The temperature sensor is not working properly. The measured values may not be correct.</p>	<p>A Contact your sales and service partner.</p>
"ECG cable invalid"	System	Medium	<p>A The used ECG monitoring cable is invalid.</p>	<p>A Replace ECG monitoring cable.</p>

Alarm text	Type of alarm	Priority	Cause	Measure
"ECG cable loose"	System	Medium	<p>A The ECG monitoring cable is not connected to the corpuls1.</p> <p>B The ECG monitoring cable is not connected correctly to the corpuls1.</p>	<p>A Connect the ECG monitoring cable to the corpuls1.</p> <p>B Disconnect the ECG monitoring cable from the corpuls1 and re-connect.</p>
<p>"ECG electrode L/LA loose"</p> <p>"ECG electrode F/LL loose"</p> <p>"ECG electrode R/RA loose"</p>	Patient (technical)	Medium	<p>A The clip of the ECG monitoring cable is loose.</p> <p>B The ECG electrode is not attached to the patient.</p> <p>C ECG electrode does not have sufficient contact to the patient.</p>	<p>A Connect the clip of the ECG monitoring cable to ECG electrode.</p> <p>B Attach ECG electrode to patient.</p> <p>C Check ECG electrode.</p>
"ECG failure (x)"	System	High	<p>An error occurred in the ECG module. The "X" is a placeholder for a specified number of the alarm.</p> <p>A ECG monitoring does not function correctly.</p>	<p>A Do not use the ECG monitoring function on patients.</p> <p>B Contact your sales and service partner.</p>
"ECG-Module not detected"	System	High	A Communication with the ECG module is not possible.	A Contact your sales and service partner.
"Error CPR module"	System	Medium	Check the CPR sensor and the CPR intermediate cable and replace, if necessary. If the alarm message persists, the measuring option mentioned is faulty.	A Contact your sales and service partner.
"Error CPR sensor"	System	Medium	The sensor mentioned is defective and has to be exchanged with a new one.	A Contact your sales and service partner.
"Heart rate too high"	Patient (physiological)	High	A The measured heart rate exceeds the upper alarm limit.	A Check the patient's vital signs.
"Heart rate too low"	Patient (physiological)	High	A The measured heart rate falls below the lower alarm limit.	A Check the patient's vital signs.
"Internal memory almost full"	System	Low	A The remaining memory capacity of the device is $\leq$ 20 %.	<p>A Switch off the corpuls1 within approx. 15 min.</p> <p>B Make sure that an SD card with more than 1 GB free memory is inserted in the corpuls1.</p> <p>C Switch on the corpuls1 again. The alarm should disappear after max. 10 min.</p>

Alarm text	Type of alarm	Priority	Cause	Measure
"Inval. No Oxi cable"	System	Medium	A The connected pulse oximetry intermediate cable is invalid or defective.	A Replace pulse oximetry intermediate cable.
"Invalid Oxi adhes. sensor"	System	Medium	A The pulse oximetry adhesive sensor is invalid or defective.	A Replace pulse oximetry adhesive sensor.
"Invalid Oxi sensor"	System	Medium	A The pulse oximetry sensor is invalid or defective.	A Replace pulse oximetry sensor.
"Key permanently pressed"	System	High	A A softkey or a key has been held down for longer than 20 s.	A Do not hold down softkeys or keys for longer than necessary. B Contact your sales and service partner.
"Low confidence PI"	System	Medium	A The displayed reading may deviate from the actual reading.	A Make sure that the correct sensor is attached to the patient. B Check if the sensor works correctly. C If the sensor is not functioning correctly, exchange sensor.
"Low confidence PR"	System	Medium	A The displayed reading may deviate from the actual reading.	A Make sure that the correct sensor is attached to the patient. B Check if the sensor works correctly. C If the sensor is not functioning correctly, exchange sensor.
"Low confidence SpCO"	System	Medium	A The displayed reading may deviate from the actual reading.	A Make sure that the correct sensor is attached to the patient. B Check if the sensor works correctly. C If the sensor is not functioning correctly, exchange sensor.
"Low confidence SpHb"	System	Medium	A The displayed reading may deviate from the actual reading.	A Make sure that the correct sensor is attached to the patient. B Check if the sensor works correctly. C If the sensor is not functioning correctly, exchange sensor.

Alarm text	Type of alarm	Priority	Cause	Measure
"Low confidence SpMet"	System	Medium	A The displayed reading may deviate from the actual reading.	A Make sure that the correct sensor is attached to the patient. B Check if the sensor works correctly. C If the sensor is not functioning correctly, exchange sensor.
"Low confidence SpO2"	System	Medium	A The displayed reading may deviate from the actual reading.	A Make sure that the correct sensor is attached to the patient. B Check if the sensor works correctly. C If the sensor is not functioning correctly, exchange sensor.
"Low perfusion SpCO"	Patient (physiological)	Medium	A The measured signal is too weak.	A Make sure that the patient lies calmly during the measurement. B Choose another measurement site.
"Low perfusion SpHb"	Patient (physiological)	Medium	A The measured signal is too weak.	A Make sure that the patient lies calmly during the measurement. B Choose another measurement site.
"Low perfusion SpMet"	Patient (physiological)	Medium	A The measured signal is too weak.	A Make sure that the patient lies calmly during the measurement. B Choose another measurement site.
"No batt. inserted"	System	High	A The battery is not inserted. B The battery is not inserted correctly.	A Insert the battery. B Remove battery and re-insert. C Insert new battery.

Alarm text	Type of alarm	Priority	Cause	Measure
"No ECG cable (DEMAND)"	System	High	<p>The DEMAND mode is called up. The pacemaker is stimulating in DEMAND mode.</p> <p>A The 4-pole ECG monitoring cable is not connected to the corpuls1.</p> <p>B The ECG electrodes are not attached to the patient.</p>	<p>A Check if the 4-pole ECG monitoring cable is connected correctly to the corpuls1 and re-connect, if necessary. (refer to 11.8.1 corPatch easy Electrodes or Shock Paddles (Accessories) on page 101).</p> <p>B Check if the corPatch easy electrodes are correctly attached to the patient and re-attach, if necessary (refer to 11.10.2 corPatch easy Electrodes for Pacemaker Therapy (Accessories) on page 106).</p>
"No Oxi adhesive sensor"	System	Medium	<p>A The pulse oximetry adhesive sensor is defective.</p> <p>B The pulse oximetry adhesive sensor has expired.</p>	<p>A Replace pulse oximetry adhesive sensor.</p>
"No Oxi cable"	System	Medium	<p>A The pulse oximetry intermediate cable is not connected to the corpuls1.</p> <p>B The pulse oximetry intermediate cable is not connected properly to the corpuls1.</p>	<p>A Connect the pulse oximetry intermediate cable to the corpuls1.</p> <p>B Disconnect the pulse oximetry intermediate cable from the corpuls1 and re-connect.</p>
"No Oxi sensor"	System	Medium	<p>A The pulse oximetry sensor cable is not connected to the pulse oximetry intermediate cable.</p> <p>B The pulse oximetry sensor cable is not or not properly connected to the pulse oximetry intermediate cable.</p>	<p>A Connect the pulse oximetry intermediate cable to the pulse oximetry sensor cable.</p> <p>B Disconnect the pulse oximetry sensor cable from the pulse oximetry intermediate cable and connect again.</p> <p>C If the LED of the pulse oximetry sensor does not flash, the pulse oximetry sensor has to be exchanged.</p>
"ONLY FOR DEVELOPMENT"	System	High	<p>A The software version of the corpuls1 is a beta version. The corpuls1 must exclusively be used for test purposes.</p>	<p>A Take the corpuls1 out of commission.</p> <p>B Contact your sales and service partner.</p>
"ONLY FOR TEST PURPOSE"	System	High	<p>A The software version of the corpuls1 is a beta version. The corpuls1 must exclusively be used for test purposes.</p>	<p>A Take the corpuls1 out of commission.</p> <p>B Contact your sales and service partner.</p>
"Oxi adhes. sensor expired"	System	Medium	<p>A The pulse oximetry adhesive sensor has expired.</p>	<p>A Replace pulse oximetry adhesive sensor.</p>



Alarm text	Type of alarm	Priority	Cause	Measure
"Oxi cable expired"	System	Medium	A The pulse oximetry adhesive sensor has expired.	A Replace pulse oximetry cable.
"Oxi failure (1)"	System	Medium	An error occurred in the pulse oximetry module. A The readings are unreliable. B The readings are invalid.	A Do not use pulse oximetry measuring option on patients.
"Oxi failure (2)"	System	Medium	An error occurred in the pulse oximetry module. A The memory is full.	A Do not use pulse oximetry measuring option on patients.
"Oxi sensor expired"	System	Medium	A The pulse oximetry sensor has expired.	A Replace pulse oximetry sensor.
"Oxi: Check connection to c1"	System	Medium	A The pulse oximetry sensor cable is not or not properly connected to the pulse oximetry intermediate cable. B The pulse oximetry intermediate cable is not connected properly to the corpuls1.	A Disconnect the pulse oximetry sensor cable from the pulse oximetry intermediate cable and connect again. B Disconnect the pulse oximetry intermediate cable from the corpuls1 and re-connect.
"Oxi: Demo tool"	System	Medium	A The pulse oximetry sensor demo tool is connected.	A Do not use pulse oximetry sensor demo tool on patients.
"Oxi: Interference"	System	Medium	A Too strong ambient light on pulse oximetry sensor.	A Remove or reduce light source. B Protect the pulse oximetry sensor from light by using an ambient shield. C Attach pulse oximetry sensor at a different measuring site. D Remove or reduce light source.
"Oxi: low perfusion"	Patient (physiological)	Low	A The measured signal is too weak.	A Make sure that the patient lies calmly during the measurement. B Choose another measurement site.
"Oxi: SpO <sub>2</sub> only mode"	System	Medium	A If the calibration of the vital parameters SpCO, SpMet and SpHb is not possible, the corpuls1 switches to SpO <sub>2</sub> only mode.	A To calibrate the pulse oximetry sensors again, disconnect the sensor from the measuring site and re-connect.

Alarm text	Type of alarm	Priority	Cause	Measure
"Pacer circuit open"	System	High	<p>A The corPatch easy electrodes are not connected correctly to the corpuls1.</p> <p>B corPatch easy electrodes are not correctly attached to the patient.</p>	<p>A Check if the corPatch easy electrodes are connected correctly to the corpuls1 and re-connect, if necessary (refer to 11.8.1 corPatch easy Electrodes or Shock Paddles (Accessories) on page 101).</p> <p>B Check if the corPatch easy electrodes are correctly attached to the patient and re-attach, if necessary (refer to 11.10.2 corPatch easy Electrodes for Pacer Therapy (Accessories) on page 106).</p>
"Pacer failure"	System	High	<p>An error occurred in the defibrillator or pacer.</p> <p>A The defibrillator or pacer does not function correctly.</p>	<p>A Do not use defibrillator- or pacer function on patients.</p> <p>B Contact your sales and service partner.</p>
"Pacer high impedance"	System	High	<p>A The patient impedance is too high for the selected intensity of the pacer pulse. Pacer pulses cannot reach the selected intensity.</p>	<p>A Check if the corPatch easy electrodes are correctly attached to the patient and re-attach, if necessary (refer to 11.10.2 corPatch easy Electrodes for Pacer Therapy (Accessories) on page 106).</p> <p>B To allow pacer therapy, select a higher intensity for the pacer pulse (refer to 11.5.4 Performing Pacer Therapy on page 93).</p>
"Pacer short circuit"	System	High	<p>A corPatch easy electrodes are not placed correctly so that pacer therapy is not possible.</p>	<p>A Make sure that the corPatch easy are placed with sufficient distance to each other on the patient.</p> <p>B Make sure that there is no conductive connection between the corPatch electrodes e. g. wetness.</p>

Alarm text	Type of alarm	Priority	Cause	Measure
"Paddle interface error (X)"	System	High	An error occurred at the paddle interface. The "X" is a placeholder for a specified number of the alarm. A The paddle interface does not function correctly. B The paddle interface is possibly no longer available.	A Do not use defibrillator on patients. B Contact your sales and service partner.
"Pulse rate too high"	Patient	High	A The measured peripheral pulse exceeds the upper alarm limit.	A Check the patient's vital signs.
"Pulse rate too low"	Patient (physiological)	High	A The measured peripheral pulse rate falls below the lower alarm limit.	A Check the patient's vital signs.
"Remaining runtime < 10 min"	System	High	A The remaining running time of the battery is just only 10 min.	A Switch off the corpuls1 so that all mission data can be saved correctly.
"Replace battery"	System	High	A Maximum charging status of the charged battery < 50 %.	A Dispose of the old battery and insert a new battery.
"SD card almost full"	System	Low	A The memory of the SD card is 80 % full.	A Transfer the mission data from the SD card to another data carrier. B Insert an empty SD card.
"SD card full"	System	Low	A There is no more memory capacity on the SD card.	A Transfer the mission data from the SD card to another data carrier. B Insert an empty SD card.
"SD card missing"	System	Low	A The SD card is not inserted.	A Insert the SD card. B Remove SD card and re-insert.
"SpCO too high"	Patient (physiological)	Medium	A The measured SpCO value exceeds the upper alarm limit.	A Check the patient's vital signs.
"SpCO too low"	Patient (physiological)	Medium	A The measured SpCO value falls below the lower alarm limit.	A Check the patient's vital signs.
"SpHb too high"	Patient (physiological)	Medium	A The measured SpHb value exceeds the upper alarm limit.	A Check the patient's vital signs.
"SpHb too low"	Patient (physiological)	Medium	A The measured SpHb value falls below the lower alarm limit.	A Check the patient's vital signs.

Alarm text	Type of alarm	Priority	Cause	Measure
"SpMet too high"	Patient (physiological)	Medium	A The measured SpMet value exceeds the upper alarm limit.	A Check the patient's vital signs.
"SpMet too low"	Patient (physiological)	Medium	A The measured SpMet value falls below the lower alarm limit.	A Check the patient's vital signs.
"SpO2 too high"	Patient (physiological)	Medium	A The measured SpO <sub>2</sub> value exceeds the upper alarm limit.	A Check the patient's vital signs.
"SpO2 too low"	Patient (physiological)	Medium	A The measured SpO <sub>2</sub> value falls below the lower alarm limit.	A Check the patient's vital signs.
"B-SW - NOT FOR PAT. USE"	System	High	A The software version of the corpuls1 is a beta version. The corpuls1 must exclusively be used for test purposes.	A Take the corpuls1 out of commission. B Contact your sales and service partner.
"System under test by remote"	System	High	A The software version of the corpuls1 is a beta version. The corpuls1 must exclusively be used for test purposes.	A Take the corpuls1 out of commission. B Contact your sales and service partner.
"Therapy electrode cable defective"	System	High	A Connected therapy electrode cable is defective.	A Replace therapy electrode cable.
"Therapy electrode cable invalid"	System	High	A Connected therapy electrode cable is invalid.	A Replace therapy electrode cable.
"Therapy electrode cable loose"	System	High	A Therapy electrode cable is not connected to the corpuls1. B Therapy electrode cable is not connected correctly to the corpuls1.	A Connect the therapy electrode cable to the corpuls1. B Disconnect the therapy electrode cable from the corpuls1 and re-connect.
"Therapy electrode invalid (x)"	System	High	The "X" is a placeholder for a specified number of the alarm. A The connected therapy electrode is invalid.	A Replace therapy electrode.
"Time/date invalid"	System	Low	A The configured time is invalid. B The configured date is invalid.	A Set correct time and date.
"VT/VF possible"	Patient (physiological)	High	A There is possibly an arrhythmia in form of a ventricular fibrillation.	A Check the patient's vital signs. B Starting ECG analysis.

Alarm text	Type of alarm	Priority	Cause	Measure
"Wrong pacing electrodes"	System	High	Pacer mode is called up. A Shock paddles or shock spoons are connected to the corpuls1.	A Connect corPatch easy electrodes.

Table 17-1 Alarms

### 17.3 List of Messages

The following table gives an overview of the messages that may occur during operation. Message can be displayed in different places, e. g. in the message line or the status line. The respective place is indicated in the column *Description*.

Messages can either inform the user or prompt the user to take measures.

Messages that inform the user are marked with -- in the column *Measures*.

Messages that prompt the user to take measures are labelled with letters in the column *Measure*. The user must carry out the measures one by one from A to Z until one of the measures proves successful.

Information/message	Description	Measure
#	Message in the message line indicating an invalid text ID.	A If the message persists, contact authorised sales and service partners. B Pay attention to occurring alarms.
<b>Alarm OFF</b>	Message in the status line that the alarm suspension is activated.	--
<b>Attach corPatch CPR Sensor</b>	Message in defibrillation mode to use and attach the corPatch CPR sensor.	A Connect corPatch CPR sensor to corpuls1 and attach to patient.
<b>Charging</b>	The message in defibrillator mode that the corpuls1 is charging the defibrillator.	--
<b>Charging not possible</b>	Message in defibrillation mode that the defibrillator cannot be charged.	A Due to a technical error or because the temperature of the charging generator has exceeded a limit value, the corpuls1 needs to cool down. B If the problem persists, contact your authorised sales and service partners.
<b>Check plug of therapy cable</b>	Message in pacer mode to check the therapy cable.	A Check therapy cable and disconnect and re-connect plug, if necessary. B If the problem persists, contact your authorised sales and service partners.
<b>Check software recently installed</b>	Message in the message line to check the software that has been installed.	A Accept and confirm the installed software or repeat procedure by pressing the softkey [Again].

Information/message	Description	Measure
<b>Check therapy electrodes</b>	Message to check the therapy electrodes. The message appears simultaneously to the audio instructions.	A Check if therapy electrodes are connected. B If necessary, use new therapy electrodes.
<b>Code changed</b>	Confirmation that the user has successfully changed the access code.	--
<b>Code invalid - Retry?</b>	Message that the user has entered an invalid access code.	A To enter the correct access code, repeat.
<b>Code mismatch - Retry?</b>	Message that the entry or repetition of the access code for user level MAN. DEFIB. is not correct.	A To enter the correct access code, repeat.
<b>Collecting data...</b>	Message in the message line that the corpuls1 is creating a summary of the software update.	--
<b>Configuration stored</b>	Message that the corpuls1 has stored the settings.	--
<b>Connect ECG cable</b>	User prompt to connect the ECG cable. The message appears simultaneously to the audio instructions.	A Check if ECG electrodes are connected. B To obtain ECG signals, the ECG cable has to be connected.
<b>Connect ECG electrode</b>	User prompt to connect the ECG electrodes.	A To obtain ECG signals, the ECG electrodes have to be connected.
<b>Connect pacer cable</b>	User prompt in pacer mode to connect the cable of the therapy electrodes.	A To be able to perform pacer therapy, connect therapy cable.
<b>Connect therapy electrodes</b>	Message to connect the therapy electrodes. The message appears simultaneously to the audio instructions.	A To be able to perform therapy, connect the therapy electrodes.
<b>Continue pacing?</b>	Confirmation prompt in pacer mode if pacer therapy should be continued.	A The user can confirm this prompt.
<b>Defib device calibrating</b>	The message in defibrillator mode that the defibrillator unit in thecorpuls1 is calibrating.	A If the message persists, contact authorised sales and service partners.
<b>Defib device not operational</b>	Message that the defibrillator is not operational.	A Do not use defibrillator on patients. B If the problem persists, contact your authorised sales and service partners.
<b>Deliver shock</b>	Message in defibrillation mode that the user can deliver the shock. The message appears simultaneously to the audio instructions.	A The user can deliver a shock.

Information/message	Description	Measure
<b>Do not remove SD card</b>	Message that the corpuls1 is shutting down and is copying mission data to the SD card.	A Do not remove SD card.
<b>Do not touch and move patient</b>	Message in defibrillation mode not to touch the patient. The message appears simultaneously to the audio instructions.	A When the corpuls1 delivers a shock, there is a possible risk for the user.
<b>ECG cable connected</b>	Message that the ECG cable is connected.	--
<b>ECG electrode loose</b>	Message that the ECG electrodes are not connected (properly). The message appears simultaneously to the audio instructions.	A Check if ECG electrodes are connected. B Connect ECG cable to the corpuls1. C Connect ECG cable to the patient.
<b>Enter code:</b>	User prompt to enter a new access code.	A To log in to the user level, enter the respective access code.
<b>Enter new code:</b>	User prompt to enter a new access code.	A Enter a new access code.
<b>Export to SD card failed</b>	Message in monitoring mode that the export to SD card has failed.	A Repeat export to SD card.
<b>Export to SD card successful</b>	Message in monitoring mode that the export to SD card has been successful.	--
<b>Failure, shutting down system</b>	Message in the message line that an error has occurred during the software update and that the corpuls1 is switching off.	A Switch on the corpuls1. B Start the update procedure again. C If the problem persists, contact your authorised sales and service partners.
<b>Formatting SD card failed</b>	Message in the message line indicating that the formatting of the SD card has failed.	A Repeat the formatting of the SD card.
<b>Formatting SD card successful</b>	Message in the message line indicating that the formatting of the SD card has been successful.	--
<b>Formatting SD card...</b>	Message that the corpuls1 is formatting the SD card.	A Do not remove SD card.
<b>Formatting SD card? Mission data will be deleted.</b>	Confirmation prompt if the SD card should be formatted. Mission data on the SD card will be deleted.	A The user can confirm this prompt.
<b>Good compressions</b>	The message in the message line of the defibrillator mode that the recommended pressure depth of chest compression has been reached. The message appears simultaneously to the audio instructions.	A Continue with the depth of the thorax compressions.

Information/message	Description	Measure
<b>Hold down Shock key</b>	User prompt in defibrillation mode to hold down the <b>Shock</b> key.	A To deliver a shock, hold down the <b>Shock</b> key until the corpuls1 has delivered the shock.
<b>Import from SD card failed</b>	Message that the import from SD card has failed.	A Repeat import from SD card. B If the problem persists, contact your authorised sales and service partners.
<b>Import from SD card successful</b>	Message that the import from SD card has been successful.	--
<b>MAN. DEFIB. code correct</b>	Message that the access code for user level MAN. DEFIB. is correct.	--
<b>MAN. DEFIB. code incorrect</b>	Message that the access code for user level MAN. DEFIB. is not correct.	A Enter the correct access code for user level MAN. DEFIB.
<b>Manual defibrillation mode confirmed</b>	The message that the corpuls1 has switched to manual defibrillation mode.	--
<b>Manual defibrillation mode?</b>	Confirmation prompt in AED mode if the user wants to switch to manual mode.	A If a switch to manual defibrillation mode is intended, press softkey [OK].
<b>Mark as test mission?</b>	Message in the message line. The user can mark this mission as test mission.	A To mark this mission as test mission confirm the prompt.
<b>Marked as test mission</b>	Message that the mission has been marked as test mission.	--
<b>New code invalid - Retry?</b>	User prompt to repeat the new code correctly.	A Enter the access code again. B If the problem persists, contact your authorised sales and service partners.
<b>No connection to defibrillator unit</b>	Message that there is no connection to the defibrillator.	A Do not use defibrillator on patients. B If the problem persists, contact your authorised sales and service partners.
<b>No ECG cable (DEMAND)</b>	Message in pacer mode DEMAND that no ECG cable is connected.	A To be able to perform pacer therapy in DEMAND mode, connect an ECG cable. B If the problem persists, contact your authorised sales and service partners.
<b>No packages found</b>	Message in the message line that the corpuls1 found no update packages on the SD card.	A Check if there is an update package on the SD card.
<b>No SD card</b>	Message in update mode that no SD card with update files is inserted.	A Insert an SD card to the corpuls1. B If an SD card is inserted, remove and re-insert.
<b>Oximetry cable connected</b>	Message that the oximetry cable is connected.	--



Information/message	Description	Measure
<b>Pacer circuit open</b>	Message in pacer mode that the pacer circuit is open.	<p>A The corPatch electrodes are not connected correctly to the patient or they have a too high resistance to the patient's skin. Stimulation is not possible.</p> <p>B Check if the electrodes connected to the patient are positioned and attached properly and not dried out.</p>
<b>Pacer device not operational</b>	Message that the pacer is not operational.	<p>A Do not use pacer function on patients.</p> <p>B If the problem persists, contact your authorised sales and service partners.</p>
<b>Pacer failure</b>	Message in the message line of the pacer mode that an error has occurred in the pacer.	<p>A If the problem persists, contact your authorised sales and service partners.</p>
<b>Pacer high impedance</b>	Message in pacer mode that the impedance is too high.	<p>A To be able to perform therapy, check the patient's impedance and take appropriate measures (refer to 11.4.2 Patient Impedance on page 77).</p>
<b>Pacer short circuit</b>	Message in pacer mode that there is a short circuit.	<p>A To be able to perform pacer therapy, eliminate the short circuit.</p>
<b>Pacing</b>	Message in pacer mode that pacer therapy is running.	--
<b>Package corrupted</b>	Message in the message line that the update package is unusable or corrupted.	<p>A Check if there is an update package on the SD card.</p> <p>B Delete update package from the SD card and copy again.</p> <p>C Contact your authorised sales and service partner for a new SD card with update package.</p>
<b>Package corrupted, retry</b>	Message in the message line that the update package is unusable or corrupted.	<p>A Restart the procedure with the softkey [Again].</p> <p>B Delete update package from the SD card and copy again.</p> <p>C If the problem persists, contact your authorised sales and service partners.</p>
<b>Package not accessible</b>	Message in the message line that the corpuls1 could not access the update package.	<p>A Check if there is an update package on the SD card.</p> <p>B Delete update package from the SD card and copy again.</p> <p>C If the problem persists, contact your authorised sales and service partners.</p>

Information/message	Description	Measure
<b>Package not accessible, retry</b>	Message in the message line that the update package cannot be accessed.	A Restart the procedure with the softkey [Again]. B Delete update package from the SD card and copy again. C If the problem persists, contact your authorised sales and service partners.
<b>Pause</b>	Message in pacer mode that the corpuls1 has paused pacer therapy.	A Continue pacer therapy if necessary.
<b>Pause pacing?</b>	Confirmation prompt in pacer mode if pacer therapy should be paused.	A The user can confirm this prompt.
<b>Perform CPR</b>	User prompt in defibrillation mode to perform cardio-pulmonary resuscitation. The message appears simultaneously to the audio instructions.	A Perform cardio-pulmonary resuscitation.
<b>Perform preShock CPR</b>	Message in the message line of AED mode that the corpuls1 has started the preShock CPR phase.	--
<b>Permanent alarm suspension</b>	Message that the alarm suspension is permanently active.	--
<b>Please wait ...</b>	Message that the corpuls1 is saving data on the SD card.	--
<b>Please wait...</b>	Message in the message line that the software update is running.	--
<b>Power off?</b>	Confirmation prompt if the corpuls1 should be switched off.	A The user can confirm this prompt.
<b>Press OK to start update</b>	Message in the message line to confirm software update.	A Press softkey [OK] to start update.
<b>Press shock paddle buttons again</b>	User prompt in the message line in defibrillation mode to press the shock paddle buttons APEX and STERNUM one or more times.	A To contact the shock paddle buttons sufficiently, press the shock paddle buttons one or more times. B If after several presses the message <b>Check therapy electrodes</b> appears, proceed as described in this message. C If the problem persists, contact your authorised sales and service partners.
<b>Push harder</b>	Message in defibrillation mode indicating that the recommended depth of the thorax compressions has not been reached. The message appears simultaneously to the audio instructions.	A Increase depth of compressions until the recommended depth has been reached.

Information/message	Description	Measure
<b>Push harder, fully release</b>	Message in defibrillation mode indicating that the recommended depth of the thorax compressions has not been reached. If activated, the message to fully release the thorax also appears. The message appears simultaneously to the audio instructions.	A Increase depth of compressions until the recommended depth has been reached. B If the message "Fully release" is activated, regularly release the thorax fully.
<b>Ready for charging</b>	Message in defibrillation mode that the defibrillator can be charged.	A To charge the shock energy, press the <b>Charge</b> key.
<b>Ready for shock</b>	Message in defibrillation mode that the user log-in has been successful.	A To deliver the shock, press the <b>Shock</b> key.
<b>Rebooting system...</b>	Message in update mode that the corpuls1 is re-starting the device as part of the update procedure.	--
<b>Recommended electrode placement</b>	Message in pacer mode to attach the corPatch easy electrodes.	A Connect corPatch easy electrodes to the corpuls1 and attach to patient.
<b>Re-enter new code:</b>	User prompt to repeat the new code.	A Repeat the new code.
<b>Reset code?</b>	Message asking if the access code should be reset to factory settings.	--
<b>Restore previous user settings?</b>	Confirmation prompt in the message line if the previous user settings should be adopted in the updated software version.	A The user can confirm this prompt.
<b>Restoring previous user settings failed</b>	Message in the message line that the corpuls1 could not restore the previous user settings after the software update.	A Import the user settings via the SD card from another device. B Configure the corpuls1 again. C If the problem persists, contact your authorised sales and service partners.
<b>Retrieving package info failed</b>	Message in the message line that the corpuls1 could not retrieve information about the update package.	A Check if there is an update package on the SD card. B Delete update package from the SD card and copy again. C If the problem persists, contact your authorised sales and service partners.
<b>Retrieving package info...</b>	Message in the message line that the corpuls1 is checking the content of the selected update package.	--

Information/message	Description	Measure
<b>Retrieving packages failed</b>	Message in the message line that the corpuls1 could not retrieve update packages.	A Check if there is an update package on the SD card. B Delete update package from the SD card and copy again. C If the problem persists, contact your authorised sales and service partners.
<b>Screenshot failed</b>	Message that the creation of a screenshot has failed.	A Repeat screenshot procedure. B If the problem persists, contact your authorised sales and service partners.
<b>Screenshot successful</b>	Message that the corpuls1 has created a screenshot.	--
<b>Searching for service events...</b>	Message that the corpuls1 is collecting service events during the shut-down procedure.	A Wait until the corpuls1 has collected all service events.
<b>Searching for update packages...</b>	Message in the message line that the corpuls1 is searching for update packages on the SD card.	--
<b>Select energy</b>	User prompt in defibrillation mode to select the shock energy.	A To be able to perform a defibrillation (manual mode/AED mode), select the shock energy.
<b>Select frequency</b>	User prompt in pacer mode to select a stimulation frequency.	A To begin pacer therapy, select stimulation frequency.
<b>Select intensity</b>	User prompt in pacer mode to select a pacing intensity.	A To begin pacer therapy, select intensity.
<b>Select intensity/frequency</b>	User prompt in pacer mode to select a pacing intensity and/or -frequency.	A Select a pacing intensity and/or -frequency.
<b>Select mode</b>	User prompt to select a pacer mode after pressing the softkey [Mode].	A To prepare pacer therapy, select one of the pacer modes.
<b>Select modules</b>	Message in the message line to select and confirm update modules.	A Select one or more software/firmware modules and confirm.
<b>Select the package to be installed</b>	Message in the message line to select and confirm an update package.	A Select and confirm an update package.
<b>Shock aborted</b>	Message in defibrillation mode that the corpuls1 has discharged internally.	A To be able to perform therapy, check the patient's impedance and take appropriate measures (refer to 11.4.2 Patient Impedance on page 77). B If the problem persists, contact your authorised sales and service partners.
<b>Shock not recommended</b>	The message in the message line in defibrillator mode that the corpuls1 does not recommend a shock. The message appears simultaneously to the audio instructions.	A Continue with other measures according to the general guidelines.

Information/message	Description	Measure
<b>Shock performed</b>	Message in defibrillation mode that the corpuls1 has delivered the shock. The message appears simultaneously to the audio instructions.	--
<b>Shutting down system...</b>	Message in the message line that the corpuls1 is shutting down.	--
<b>Start analysis</b>	Message in the message line of AED mod to start analysis. The message appears simultaneously to the audio instructions.	A To start the ECG analysis, press the <b>Analyse</b> key.
<b>Storing configuration failed</b>	Message that the storage process has failed.	A Repeat storage process. B If the problem persists, contact your authorised sales and service partners.
<b>Suspending module operation...</b>	Message in update mode that the corpuls1 is suspending operation of modules.	--
<b>Switch off pacer?</b>	Confirmation prompt in pacer mode if pacer therapy should be terminated in order to switch to manual or AED defibrillation mode.	A To switch off the pacer, confirm.
<b>Switch pacer to FIX mode?</b>	Confirmation prompt in pacer mode if the device should switch to FIX mode or if pacer therapy should be terminated. Cause: e. g. ECG monitoring cable removed.	A To be able to perform pacer therapy in DEMAND mode, connect the ECG monitoring cable. B If the confirmation prompt persists, check if the device can safely switch to FIX mode. C If the problem persists, contact your authorised sales and service partners.
<b>System shutdown in XX s</b>	Message that the corpuls1 is shutting down in XX s.	A Press softkey [Now] to save event data and immediately shut down the corpuls1. B Press softkey [Cancel] to cancel the shutdown process. The risk, however, is a loss of mission data.
<b>Temporary alarm suspension for [NUMBER] s</b>	Message that the alarm suspension is temporarily active for [NUMBER] s.	--
<b>Therapy cable connected, select patient class</b>	Message in the message line that the therapy cable is connected and the user can select the patient class/-group.	A Select patient class. B If the user does not select a patient group, the corpuls1 uses the default patient group for the connected therapy electrodes.

Information/message	Description	Measure
<b>Therapy electrodes loose</b>	Message in defibrillation mode that the therapy electrodes are not connected (properly). The message appears simultaneously to the audio instructions.	A Check if therapy electrodes are connected. B Connect therapy electrodes to the corpuls1. C Attach therapy electrodes to the patient.
<b>Unpacking modules failed</b>	Message in the message line that the unpacking of update components has failed.	A Check if there is an update package on the SD card. B Delete update package from the SD card and copy again. C If the problem persists, contact your authorised sales and service partners.
<b>Unpacking modules...</b>	Message in update mode that the corpuls1 is unpacking the selected software update components.	--
<b>Update completed, rebooting system...</b>	Message in the message line that the corpuls1 has finished the update procedure and is re-starting.	--
<b>Update failed, check current software versions</b>	Message in the message line that the software update has failed and prompt to check the currently installed software version.	A Check the available software/firmware packages on the SD card. B Restart the procedure with the softkey [Again].
<b>Update failed, retry</b>	Message in the message line that the software update has failed.	A Start the update procedure again. B Check if there is an update package on the SD card. C If the problem persists, contact your authorised sales and service partners.
<b>Update in progress...</b>	Message in update mode that the software update is running.	--
<b>Update manager not available, retry</b>	Message in the message line. The update manager is not available.	A The user can confirm this prompt.
<b>User [XY] logged in successfully</b>	Message in the message line indicating that the user log-in has been successful.	--
<b>Wrong therapy electrodes</b>	Message that the wrong therapy electrodes are connected. The message appears simultaneously to the audio instructions.	A To be able to perform a defibrillation, connect the correct therapy electrodes. B To be able to perform pacemaker therapy, connect the correct therapy electrodes.

Table 17-2 Messages

## 18 Charging brackets (Accessories)

---

The charging bracket (P/N: 05400) and the adapter charging bracket (P/N: 05405) allow to fixate and charge the corpuls<sup>1</sup>. The technical specifications for the charging bracket and the adapter charging bracket are summarised in the Appendix under Technical specifications (refer to H Technical Specifications on page 220).



The operator has to make sure that the technical safety check of the charging bracket and the adapter charging bracket is performed together with the technical safety check of the corpuls<sup>1</sup>.

---

### 18.1 Warnings

The following warnings inform the user of possible hazards when using the corpuls<sup>1</sup>.

#### NOTICE!

##### Use of the charging brackets in open air!

Can lead to damage to charging bracket and the adapter charging bracket or impair their function.

- ▶ Use the charging bracket and the adapter charging bracket only inside.
- 

### 18.2 Replace Fuse

If the fuse is defective, the user can replace the fuse for the charging bracket and the adapter charging bracket. The fuse holder with the fuse inserted is located at the bottom side of the charging bracket and the adapter charging bracket.

Tools:

- Flat head screwdriver size 1.0 x 5.5 mm
- New fuse, type T6.3AH 5x20 mm (P/N 56060.06300)

Prerequisite:

- The corpuls<sup>1</sup> has been removed from the charging bracket
- The AC adapter of the charging bracket is disconnected from the power supply

*To replace the fuse, proceed as follows:*

1. Unscrew the fuse holder with a slotted screw driver counterclockwise from the charging bracket.
2. Remove old fuse from the fuse holder.
3. Insert new fuse into fuse holder.
4. Screw the fuse holder with a slotted screwdriver clockwise into the charging bracket.

## 18.3 Fixating the Charging Bracket



Read the installation instruction (P/N 10002.054001).

## 18.4 Using the Charging Bracket

The user can insert the corpuls1 into the charging bracket and remove it from the charging bracket.

### 18.4.1 Inserting the Device into the Charging Bracket

To be able to use the charging bracket, the user has to insert the corpuls1 into the charging bracket.

Prerequisite:

- The battery is inserted in the corpuls1
- The charging bracket is connected to the power supply

*To insert the corpuls1 into the charging bracket, proceed as follows:*

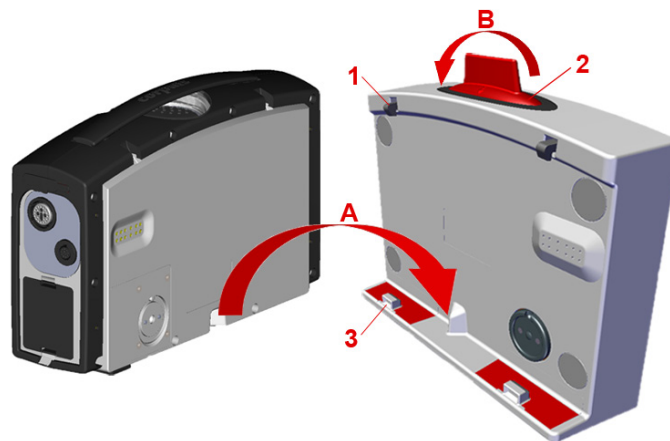

Figure 18-1 Inserting the device into the charging bracket

- |   |                 |
|---|-----------------|
| 1 | Latch           |
| 2 | Unlocking lever |
| 3 | Pin             |

1. Lift and tilt the corpuls1.  
*The corpuls1 is slightly tilted forward and its rear side is facing the charging bracket.*
2. Insert the corpuls1 into the charging bracket (item A).  
*The recesses at the bottom of the device fit onto the pins (item 3).*
3. Let the corpuls1 engage in the charging bracket.  
*The two latches (item 1) engage perceptibly at the corpuls1.*



*The LED Charging status glows orange.*



It may take up to 60 s until the LED Battery status is glowing orange.

*If no battery is inserted in the corpuls1, the corpuls1 automatically switches on and issues an alarm message that the battery is missing.*

### 18.4.2 Removing from the Charging Bracket

If the charging bracket is no longer needed, the user can remove the corpuls1 from the charging bracket.

*To remove the corpuls1 from the charging bracket, proceed as follows:*

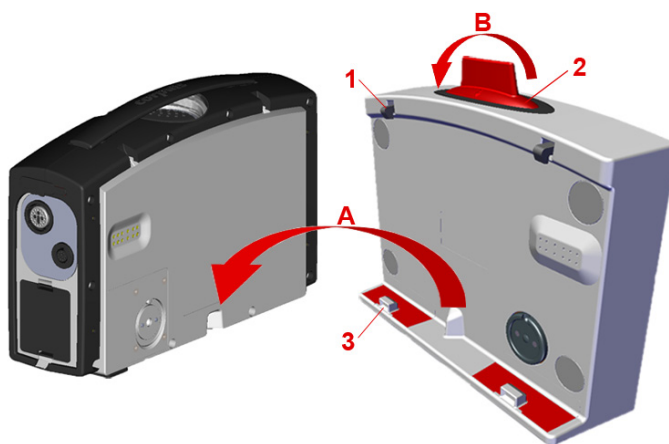

Figure 18-2 Removing from the charging bracket

- |   |                 |
|---|-----------------|
| 1 | Latch           |
| 2 | Unlocking lever |
| 3 | Pin             |

1. Pull the unlocking lever (item 2) at the charging bracket forward (item B)  
*The corpuls1 has been unlocked from the charging bracket.*
2. Remove the corpuls1 from the charging bracket.

## 18.5 Using the Adapter Charging Bracket

The user can insert the corpuls1 into the adapter charging bracket and remove it from the adapter charging bracket.

### 18.5.1 Inserting the Device into the Adapter Charging Bracket

To be able to use the adapter charging bracket, the user has to insert the corpuls1 into the adapter charging bracket.

*To insert the corpuls1 into the adapter charging bracket, proceed as follows:*

1. Inserting the adapter charging bracket into the corpuls3 charging bracket.

*The latch at the corpuls3 charging bracket engages and locks completely.*

2. Insert the corpuls1 into the adapter charging bracket.

*The LED Charging status glows orange.*



It may take up to 60 s until the LED Battery status is glowing orange.

---

*If no battery is inserted in the corpuls1, the corpuls1 automatically switches on and issues an alarm message that the battery is missing.*

### 18.5.2 Remove the Device from the Adapter Charging Bracket

If the adapter charging bracket is no longer needed, the user can remove the corpuls1 from the adapter charging bracket.

*To remove the corpuls1 from the adapter charging bracket, proceed as follows:*

1. Release the latch at the adapter charging bracket.
2. Remove the corpuls1 from the adapter charging bracket.
3. Release the latch at the corpuls3 charging bracket.
4. Remove the adapter charging bracket from the corpuls3 charging bracket.

## 19 Accessory Bags, Fold-out Supports and Front Cover (Accessories)

The left and the right accessory bag allow to safely store the pulse oximetry sensor and the ECG monitoring cable. In addition, the two accessory bags allow to hold the shock paddles. For this purpose shock paddle holders can be attached to the outside of the two accessory bags.

The front cover allows to guide the pulse oximetry sensor cable towards the right accessory bag and to safely store corPatch easy electrodes as well as the corPatch CPR disposable sensor. In addition, the front cover allows to store the therapy master cable for the shock paddles.



Figure 19-1 corpuls1 with accessory bags and front cover and shock paddle holders

- 1 Shock paddle holders left
- 2 Shock paddle holders right
- 3 Accessory bag right (with zipper)
- 4 Front cover (with opening tab on top)
- 5 Accessory bag left (with zipper)

The optional fold-out support on the back allow to prop up the corpuls1 in a stable position.

### 19.1 Warnings

The following warnings inform the user of possible hazards when using the corpuls1.

#### NOTICE!

##### **Damaged cables due to bending or coiling!**

Can lead to signal failure or cable breaks.

- ▶ Always gather the cable in loops.

## 19.2 Packing and Fixating the left Accessory Bag

Store the pulse oximetry sensor cable in the accessory bag.

In the following is described how the user can fixate the accessory bag to the left side of the device and store the pulse oximetry sensor cable in it.

Also described are the following measures:

- Guide the cable and plug of the pulse oximetry sensor through the slot at the bottom of the left accessory bag.
- Guide the cable and plug of the pulse oximetry sensor over both grooves of the front cover through the slot at the bottom of the right accessory bag towards the right side of the device.
- Fixate the front cover.
- Fixate the left fold-out support (optional) and the left accessory bag.



When the cable of the pulse oximetry intermediate cable is connected to the corpuls1, remove the plug of the pulse oximetry intermediate cable and the ECG monitoring cable from the corpuls1. This prevents damage to the plugs.

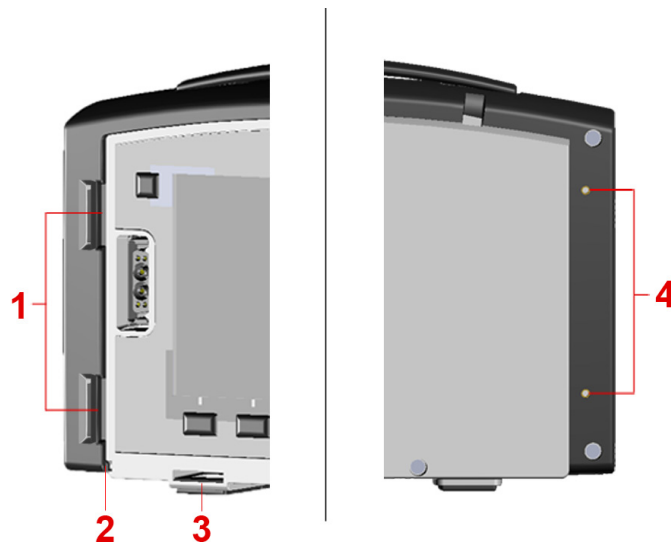

Figure 19-2 Fixating the accessory bags (Example left side)

- 1 Recess (front side of the device)
- 2 Opening for pulse oximetry intermediate cable at the groove at the bottom of the left accessory bag
- 3 Fastening socket for front cover (front side of device)
- 4 Screw threads (rear side of device)

Tools needed:

- Torx screwdriver size 10

**To pack and fixate the right accessory bag and fixate the right fold-out support, proceed as follows:**

1. Open the zipper.

2. Insert the pulse oximetry intermediate cable into the groove at the bottom of the left accessory bag.



Guide the pulse oximetry intermediate cable with the plug through the grooves of the softcover. Then guide the cable to the right side of the device. Prepare a sufficient length of cable.

*The plug of the pulse oximetry intermediate cable is on the right side of the left accessory bag.*

3. Guide both snaplock pins of the front cover towards the fastening sockets (item 3). Insert the pulse oximetry intermediate cable into the groove of the front cover. Push both front cover snaplock pins into the fastening sockets until they engage perceptibly.
4. Fit the hooks of the left accessory bag into both recesses (item 1) at the front side of the device.

*The pulse oximetry intermediate cable is threaded through the groove at the bottom of the left accessory bag (item 2) and inserted in the grooves of the front cover.*

5. Push the left accessory bag towards the rear side of the device.

*The holes of the accessory bag fit over the screw threads (item 4) at the rear side.*

6. Optional: Position the left fold-out support with both fixation holes over the holes of the left accessory bag and the screw threads.
7. Insert the provided screws into the respective screw threads (item 4) with a screw driver.

*The left accessory bag and the left fold-out support are fixated at the device.*

8. Connect the pulse oximetry intermediate cable to the pulse oximetry sensor cable and store it in the left accessory bag.
9. Close the zipper.

### 19.3 Packing and Fixating the right Accessory Bag

Store the ECG monitoring cable in the right accessory bag.

In the following is described how the user can fixate the accessory bag to the right side of the device and store the ECG monitoring cable in it.

Also described are the following measures:

- Continue the plug of the pulse oximetry intermediate cable in front of it via the front cover guide grooves and connect to the right side of the device.
- Fixate the optional right fold-out support and the right accessory bag.
- Connect the plug of the ECG monitoring cable to the right side of the device.

Tools needed:

- Torx screwdriver size 10

Prerequisite:

- Left accessory bag, fold-out support (optional) and front cover are attached at the corpuls1 (refer to 19.2 Packing and Fixating the left Accessory Bag on page 206).

***To pack and fixate the right accessory bag, proceed as follows:***

1. Open the zipper.

2. Guide the pulse oximetry intermediate cable with plug through the groove at the bottom of the right accessory bag.  
*The plug of the pulse oximetry intermediate cable is on the right side of the right accessory bag.*
3. Guide the corPatch CPR disposable sensor cable through the groove at the bottom of the right accessory bag.  
*The plug of the corPatch CPR disposable sensor cable is on the right side of the right accessory bag.*
4. Fit the hooks of the right accessory bag into both recesses (item 1) at the front side of the device.
5. Push the right accessory bag towards the rear side of the device.  
*The holes of the accessory bag fit over the screw threads (item 4) at the rear side.*
6. Position the (optional) right fold-out support with both fixation holes over the holes of the right accessory bag and the screw threads.
7. Insert the provided screws into the respective screw threads (item 4) with a screw driver.
8. Connect the pulse oximetry intermediate cable to the Oximetry interface at the right side of the corpuls1 (refer to 10.5.2 Pulse Oximetry Sensor (Accessories) on page 67).
9. Connect the ECG monitoring cable to the ECG-M interface at the right side of the corpuls1 (refer to 10.5.1 ECG Monitoring Cable (Accessories) on page 67).
10. Connect the corPatch CPR disposable cable to the CPR interface at the right side of the corpuls1 (refer to 11.8.2 corPatch CPR Disposable Sensor (Accessories) on page 103).
11. Store the ECG monitoring cable in the right accessory bag.
12. Close the zipper.

## 19.4 Pack the Front Cover

The front cover allows to accommodate corPatch easy electrodes, the corPatch CPR sensor and the therapy master cable for the shock paddles .

Prerequisite:

- Left accessory bag and left fold-out support (optional) are attached at the corpuls1 (refer to 19.2 Packing and Fixating the left Accessory Bag on page 206).
- Right accessory bag and right fold-out support (optional) are attached at the corpuls1 (refer to 19.3 Packing and Fixating the right Accessory Bag on page 207).

**To pack the front cover, proceed as follows:**

1. Open the front cover with opening tab on top.
2. Connect corPatch easy electrodes to the connection of therapy electrodes on the front side of the corpuls1 (refer to 5.2.1 Front Side of the Device on page 17).



As an alternative to the corPatch easy electrodes, shock paddles can also be connected (refer to 11.8.1 corPatch easy Electrodes or Shock Paddles (Accessories) on page 101). In this case, do not pre-connect the corPatch easy electrodes as described in this step.

3. Store the corPatch easy electrode cable in the front cover bag.

4. Accommodate and connect corPatch CPR disposable sensor in the front cover (refer to 11.8.2 corPatch CPR Disposable Sensor (Accessories) on page 103).
5. Accommodate the therapy master cable for the shock paddles in the front cover bag.
6. Close front cover.

## 19.5 Attaching Shock Paddles to Shock Paddle Holders on the Accessory Bags.

The two accessory pockets allow to hold the shock paddles by externally mounted shock paddle holders.

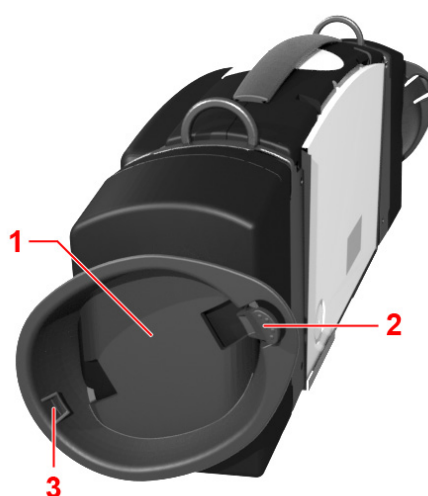

Figure 19-3 Shock paddle holders on accessory bags for attaching shock paddles

- 1 Shock paddle holders right (example)
- 2 Holding nose fixed
- 3 Holding nose flexible

### Prerequisite:

- Left and right accessory bag and left and right fold-out support (optional) are fixated at the corpuls1 (refer to 19 Accessory Bags, Fold-out Supports and Front Cover (Accessories) on page 205)
- Shock paddle holders are attached to left and right accessory pockets (optional) (refer to F Approved Accessories, Spare Parts and Consumables on page 218)
- The front cover is open.

### *To pack and fix the shock paddles, proceed as follows:*

1. Take the therapy master cable out of the front cover.
2. Connect the shock paddles to the therapy socket on the front of the corpuls1 via the therapy master cable (refer to 11.8.1 corPatch easy Electrodes or Shock Paddles (Accessories) on page 101).
3. Insert the lower side of the shock paddle (left/right) into the fixed lower holding nose (item 3) of the shock paddle holder of the left/right accessory bag until it snaps into place.

4. Insert the shock paddle (left/right) into the flexible upper holding nose (item 2) of the shock paddle holder until it snaps into place.

*Both shock paddles (left and right) are fixed in the shock paddle holders and connected to the corpuls1 via the therapy master cable.*



## Appendix

---

### A List of Abbreviations

AAM	Acoustic Advisory Mode
AC	Alternating Current
AED	Automatic external defibrillator
and the like	And the like
APOD™	Adaptive Probe Off Detection™ Technology
BF	Body Floating
CF	Cardiac Floating
CPR	Cardiopulmonary Resuscitation
DC	Direct Current
DHCP	Dynamic Host Configuration Protocol
e. g.	For example
ECG	Electrocardiogramme
ECG-M	Electrocardiogramme-Monitoring
etc.	Et cetera
etc.	And so on
HLW	Cardio-pulmonary resuscitation
HR	Heart rate
inter alia	Among others
Item	Position
kgKG	Kilogramme body weight
LAN	Local Area Network
LED	Light emitting diode
MPBetreibV	Medical Devices Operator Ordinance
MRI	Magnetic Resonance Imaging
n/a	Not available
O <sub>2</sub>	Oxygen
OP	Operation room
P/N	Product number
Para.	Paragraph
PC	Personal Computer
PI	Perfusion index
Pleth	Plethysmogramme

PR	Peripheral pulse
QRS	Indicates a QRS complex in the ECG
SC	Technical Safety Check
SFTP	Simple File Transfer Protocol
SpCO <sup>®</sup>	Carboxyhaemoglobin levels
SpHb <sup>®</sup>	Measurement of total haemoglobin levels
SpMet <sup>®</sup>	Methaemoglobin levels
SpO <sub>2</sub>	Arterial oxygen saturation
STIM	Stimulation
UMDNS	Universal Medical Device Nomenclature System
VF	Ventricular fibrillation
VP	Vital parameter
VT	Ventricular tachykardia

## B Measuring Units and Operators

Measuring units:

%	Percent
°	Degree (angle)
°C	Degree Celsius
°F	Degree Fahrenheit
μA	Microampere
μs	Microsecond
μV/bit	Microvolt/Bit
1/min	Frequency
A	Ampere
A/m	Ampere/Metre
Ah	Ampere hour
Body weight	Body weight
cm	Centimetre
cm <sup>2</sup>	Square centimetre
dB	Decibel
g	Gramme
g/dl	Gramme/Decilitre
GB	Gigabyte
GHz	Gigahertz
h	Hour
Hz	Hertz
in	Inch
J	Joule
J/kg	Joule/Kilogramme
KB	Kilobyte
kg	Kilogramme
kHz	Kilohertz
kV	Kilovolt
kΩ	Kiloohms
lb	Pound
m	Metre
mA	Milliampere
MB	Megabyte
MHz	Megahertz
min	Minute
mm	Millimetre

mm/s	Millimetres/second
mmol/l	Millimol/Litre
ms	Millisecond
mV	Millivolt
MΩ	Megaohm
nA	Nanoampere
nm	Nanometer
s	Second
sq in	Square Inch
V	Volt
V/m	Volt/metre
W	Watt
Ω	Ohm

## Operators:

<	Smaller than
≤	Smaller than or equal to
>	Greater than
≥	Greater than or equal to
±	Plusminus

## C Glossary

Term	Description
Acoustic Advisory Mode	Audio instructions of the resuscitation protocol which support the user in operating the device.
Adaptive Probe Off Detection™ Technology	Degree of sensitivity for the adaptive recognition of disconnected pulse oximetry sensors.
FastSat® algorithm	The FastSat® algorithm tracks rapid changes in SpO <sub>2</sub> saturation during the intubation phase. In case of insufficient signal quality, the corpuls1 disables the function automatically.
Medical Devices Operator Ordinance	Ordinance on the installation, operation, usage and maintenance of medical devices. Applicable in the Federal Republic of Germany.

## D Warranty

In addition to the statutory warranty conditions, the manufacturer offers a limited warranty on material defects and manufacturing faults. The scope of the warranty can be viewed in the respective guarantee conditions.

This warranty conclusively regulates the legal relationship between the purchaser and the manufacturer. Further damage claims are excluded, unless liability is prescribed by law.

Excepted from the warranty are:

- Wear parts.
- Errors and damages that are the result of
  - Improper handling
  - Faulty storage or installation
  - Extraneous causes, such as transport damage, damage caused by impact
  - Repair work and changes carried out by a non-authorized third party.

The claim under the warranty shall be void as well if accessories or spare parts are used that were not purchased from the manufacturer or from an authorised sales and service partner. Furthermore, the claim under the warranty shall be void as well if non-authorized accessories are used (refer to F Approved Accessories, Spare Parts and Consumables on page 218). Software support (except updates) is not covered under the warranty.

In case the corpuls<sup>1</sup> is defective or in case of a warranty and guarantee handling please contact an authorised sales and service partner or the manufacturer. The manufacturer shall only accept liability for user- and operating safety of the corpuls<sup>1</sup> if maintenance, technical safety checks, repairs, additions and new settings were performed by the manufacturer or persons specifically authorised by the manufacturer. Additionally, the general terms and conditions of the manufacturer shall apply in the current version until further amendment.

## E Protection Rights and Patents

The Masimo Rainbow<sup>®</sup> SET pulse oximetry technology of the company Masimo  is covered under one or more of the following U.S.A. patents: 5,758,644, 6,011,986, 6,699,194, 7,215,986, 7,254,433, 7,530,955. Other applicable patents are listed at: [www.masimo.com/patents.htm](http://www.masimo.com/patents.htm)

Purchase or possession of this Masimo Rainbow SET<sup>®</sup> pulse oximeter confers no express or implied licence to use the pulse oximeter with any non-approved sensors or cables that would fall (alone or in combination with this pulse oximeter) under any one or more patents in reference to this pulse oximeter.

It is therefore not permitted to, e. g.:

- dismantle parts of the corpuls1 and use them for other purposes.
- replicate components or accessories.

Goods are mentioned in the user manual without mention of any existing patents, samples or trademarks.

**corpuls<sup>®</sup>** is a registered trademark of GS Elektromedizinische Geräte G. Stemple GmbH.

 **GS** is a registered trademark of GS Elektromedizinische Geräte G. Stemple GmbH.

## F Approved Accessories, Spare Parts and Consumables

A list of approved accessories and consumables can be found at

*my.corpuls.world* .

For further information, consultancy and sales, please contact your authorised sales and service partner.



## G Disposal



Do not dispose of the corpuls<sup>1</sup> or the accessories via the household waste. Please ask your local authorities for information on correct disposal of the corpuls<sup>1</sup> and the accessories or return them to the manufacturer.



Dispose of the packaging of the corpuls<sup>1</sup> by means of your local institutions e. g. recovered paper container, recycling centre, paper collection etc.

## H Technical Specifications

### General technical specifications

Dimensions			
Without accessory bags and softcover	Height	17 cm	6.69 in
	Width	26 cm	10.24 in
	Depth	7 cm	2.8 in
With accessory bags and softcover	Height	17 cm	6.69 in
	Width	40 cm	15.75 in
	Depth	13.0 cm	5.12 in
Battery	Height	4.2 cm	1.65 in
	Width	4.6 cm	1.81 in
	Depth	7.6 cm	2.99 in

Table A-1 Technical specifications - dimensions

Weight		
Without accessory bags and softcover	2300 g	5.07 lb
With packed accessory bags and softcover	3250 g	7.17 lb
Battery	250 g	0.56 lb

Table A-2 Technical Specifications - Weight

Special specifications	
Vibration- and shock tests	DIN EN1789

Table A-3 Technical specifications - Special specifications

Environmental requirements				
Environmental temperature	Temperature range		Function	Akkuladestand
	-20 °C to 0 °C	-4 °F to +32 °F	Defibrillator	> 70 %
	0 °C to +55 °C	+32 °F to +131 °F		No limitations
	-20 °C to 0 °C	-4 °F to +32 °F	Pacer, ECG Monitoring, Screen	> 50 %
	0 °C to +55 °C	+32 °F to +131 °F		No limitations
	0 °C to +55 °C	+32 °F to +131 °F	Oximetry	No limitations
	-20 °C to +55 °C	-4 °F to +131 °F	Discharging the battery	No limitations
	0 °C to +40 °C	+32 °F to +104 °F	Charging the battery	No limitations

Environmental requirements			
Transient temperature (Oximetry may fail at temperatures of -20 °C (-4 °F) after approx. 15 min., see Environmental requirements)	-20 °C to +55 °C	-4 °F to +131 °F	
Warm-up time	0 min	(Storage temperature -20 °C/-4 °F, ambient temperature +20 °C/+68 °F)	
Cool-down time	10 min	(Storage temperature +65 °C/+149 °F, ambient temperature +20 °C/+68 °F)	
Relative humidity	≤95 % (without condensation)		
Barometric pressure	Barometric pressure	Height of the earth's atmosphere	
	576 hPa to 1060 hPa	4518 m to -382 m	14822.83 ft to -1253.28 ft
Protection	IP55 (dust- and splash proof)		
Operating panel	Splash proof keypad		

Table A-4 Technical Specifications - Environmental requirements

Storage temperature		
corpuls1	-40 °C to +70 °C	-4 °F to +149 °F
Battery	+10 °C to +30 °C	+50 °F to +86 °F

Table A-5 Technical Specifications - Storage temperature

Storage period Battery		
Maximum storage period for new rechargeable batteries within the specified temperature range	Battery capacity before storage at 30 %	Battery in device: 10 days.
		Battery outside of device: 400 days
	Battery capacity before storage at 100 %	Battery in device: 38 days.
		Battery outside of device: 550 days
These are the optimum storage conditions for the rechargeable battery. Storing the rechargeable battery at conditions outside these specifications can reduce the capacity of the battery or damage the battery.		
Recommended periodic battery exchange	Every 3 years. Improper handling of the battery, as e. g. storage outside the specified temperature range can reduce the battery life.	

Table A-6 Technical Specifications - Storage period Battery

Energy management and power consumption		
Internal power supply, battery	Exchangeable and chargeable lithium-ion battery.	
	Capacity	4.4 Ah at 7.4 V Nominal voltage
	Power consumption, max., charging current	3 A
	Output current, max.	4.4 A continuous
10 A for 10 s		
External power supply	Approved input voltage range	≥ 10 V
		Typical 12 V
		≤ 14 V
	Protection of the on-board power supply, 12 V	15 A, time lag fuse (T) Additional consumers on-board not taken into account
AC adapter corpuls3/corpuls1	Output power, maximum	108 W
	Voltage, nominal	12 V
	Output current, maximum	9 A
	Protection class against electrical shock when operated via mains charger (according to IEC 60601-1)	I
Power consumption of the device, typical	Thermal power dissipation (device function)	10 W
	Maximum power consumption (device operation and battery charging)	40 W
	Maximum power consumption, min. Device operation and charging of defibrillator, max. 10 s	100 W
Charging time battery	From 0 % to 80 %	Approx. 1 h
	From 0 % to 90 %	Approx. 1.5 h
	From 0 % to 100 %	Approx. 2 h
Operating time of the device	Factory settings without power saving (autoDim) mode	5.5 h
	Factory settings inverted, lowest brightness level	8.75 h
	Factory settings, ECG and SpO <sub>2</sub> active	6.5 h
	Factory settings, without accessories connected	7.3 h

Table A-7 Technical specifications - energy management and power consumption

## Memory capacity

Component	Memory capacity	
ECG data set (1-lead recording of lead II or shock paddle ECG)	Memory capacity required for ECG recording	For 45 min approx. 3.2 MB
		For 60 min approx. 4.3 MB
Event-/Mission data set	Memory capacity required for events	For 45 min approx. 90 KB
		For 60 min approx. 100 KB
	Necessary memory space of a mission directory	For 45 min approx. 3.5 MB
		For 60 min approx. 4.5 MB
Internal memory	Depending on configuration for mission recording	Up to 185 h for 1 GB total memory NOTE: The maximum mission duration depends on the available capacity of the internal memory.
External SD card	Depending on configuration for mission recording	Up to 408 h per 2 GB

Table A-8 Technical Specifications - Memory capacity

## Display

Display			
Type	5.7 in TFT colour screen VGA		
Definition	Horizontal	640 pixels	
	Vertical	480 pixels	
Visible screen	Width	11.52 cm	4.54 in
	Height	8.64 cm	3.40 in
Angle of view	Horizontal	160 °	
	Vertical	115 °	
Backlighting	Life	Approx. 15000 h	

Table A-9 Technical Specifications - screen

## Volume level Alarm tones

Volume level Alarm tones		
Alarms tone, medium and high priority	Value 3	57 dB
	Value 10	80 dB

Table A-10 Technical Specifications - Volume level Alarm tones

## Alarm management

Characteristic of alarm signal	High priority	Medium priority	Low priority	Reminder signal
Number of impulses	10	3	2	1
Impulse duration	90 ms	130 ms	190 ms	110 ms
Interval of impulses	50 ms (190 ms)	250 ms	250 ms	n/a
Frequency of impulses	523 Hz, 659 Hz, 784 Hz, 1047 Hz	523 Hz, 659 Hz, 784 Hz	659 Hz, 523 Hz	3.5 kHz
Interval	10 s	20 s	n/a	60 s
Colour of LED	Red	Yellow	Cyan	White
Flashing frequency of LED	2 Hz	0.5 Hz	n/a	n/a
Duty cycle of the LED	40 % on	40 % on	100 % on	110 ms

Table A-11 Technical specifications - alarm signal

Listed in the following are the maximum alarm delay times for the alarms of the vital parameters.

Vital parameter	Total delay time (maximum delay)	
HR	9 s	
SpO <sub>2</sub>	Averaging time	Delay
	2 s to 4 s	13 s
	4 s to 6 s	15 s
	8 s	21 s
	10 s	23 s
	12 s	24 s
	14 s	32 s
	16 s	33 s
PI	30 s	
PR	16 s	
SpMet	60 s	
SpCO	57 s	
SpHb	114 s	
The maximum delay until the signalling of an alarm for ECG and pulse oximetry is 5 s.		
The maximal delay until alarming for loose ECG electrodes is 30 s ±3 s .		

Table A-12 Technical Specifications - Alarm system delays

## Information tones (without alarm tones)

Feature of the information signal	Key tone/softkey tone	Shock ready tone	Metronome tone	QRS/PT tone
Number of impulses	1	1	Depending on the settings	1
Impulse duration	25 ms	Ends with shock readiness or shock abort	Depending on the settings	110 ms
Frequency of impulses	900 Hz	1.5 kHz	Depending on the settings	Depending on the settings
Interval	n/a	n/a	Depending on the settings	Current heart rate of the patient
Volume level	50 dB	73 dB	50 dB to 65 dB	69 dB
Tone description	Very short beep tone	Aggressive and warning sawtooth tone that does not end until the HV capacitor is discharged	Short click tones with a short pause after 15 or 30 repeats, during which two ventilation tones are played when set by the OPERATOR	Short beep tone on each patient's heartbeat

Table A-13 Technical Specifications - Information tones (without alarm tones)

## ECG

ECG - General Specifications	
Amplifier input	Type CF, insulated > 5 kV, defibrillation-proof
Frequency input	0.05 Hz to 150 Hz (-3 dB)
Input impedance	> 5 M $\Omega$
Common mode rejection (CMRR)	> 90 dB
Dynamic range	$\pm$ 350 mV (signal voltage)
Maximum electrode offset voltage	$\pm$ 300 mV (input offset)
Scanning frequency	1000 Hz
Digital definition	$\approx$ 0.8 $\mu$ V/bit
Detection of implanted pacer	$\geq$ 20 mV/0.2 ms
Electrode detection (ECG) according to IEC 60601-2-27	24 nA (maximum current)
Active noise cancellation (RL)	< 250 nA

Table A-14 Technical Specifications - ECG, general

Leads	
4-pole ECG monitoring cable	I, II, III, aVR, aVL, aVF, -aVR

Table A-15 Technical Specifications - ECG leads

Heart rate		
Heart rate display	18 /min to 300 /min	
Heart rate detection	Arithmetic averaging of the last eight RR-intervals, 30 s to 5 s (18 /min to 300 /min)	
Deviation	$\leq \pm 5$ /min or $\leq \pm 5$ %	
Maximum T-wave rejection capability according to IEC 60601-2-27	0.6 mV	
Heart rate display and comportment in case of arrhythmias according to IEC 60601-2-27	Ventricular bigeminy (A1)	80 /min
	Slow changing ventricular bigeminy (A2)	90 /min
	Fast changing ventricular bigeminy (A3)	120 /min
	Bidirectional systoles	90 /min
Response time of the heart rate after changes in heart rate according to IEC 60601-2-27	Abrupt increase, 80 /min to 120 /min	5 s
	Abrupt decrease 4 s, 80 /min to 40 /min	4 s
Alarm time for tachycardia according to IEC 60601-2-27	VT/VF 1 mV (B1)	7 s
	VT/VF 2 mV (B1 x2)	7 s
	VT/VF 0.5 mV (B1 /2)	9 s
	VT/VF 2 mV (B2)	7 s
	VT/VF 4 mV (B2 x2)	7 s
	VT/VF 1 mV (B2 /2)	7 s

Table A-16 Technical Specifications - Heart Rate

### ECG analysis

#### Procedure:

The ECG analysis is performed by a program which analyses the ECG in up to three blocks of 4 seconds with the following result:

- “Shock recommended”
- “Shock not recommended”

The ECG analysis evaluates each of the three blocks and then weighs these individual scores.

	Maximum duration of ECG analysis (12 s)			Result
Start	Block 1 (4 s)	Block 2 (4 s)	Block 3 (4 s)	Refractory time (8 s)

Table A-17 Maximum duration of the ECG analysis

If two of the three blocks yield the result “Shock recommended”, the overall result is “Shock recommended”. If two of the three blocks yield the result “shock not recommended”, the overall result is “Shock not recommended”.

If the result “Shock recommended” is established after 8 s or 12 s, a refractory time of 8 s begins. The ECG analysis does not revise the result during the refractory time so that the user can apply the shock paddles on the patient and deliver a



shock. The result of the ECG analysis does not suspend the readiness for shock, because this would cause disruptions. This refractory time would only be interrupted if a new analysis were started.

If the expected result is unambiguous early on, the ECG analysis accelerates some procedures in the process:

	ECG analysis		Result
Result	“Shock recommended”	“Shock recommended”	“Shock recommended” (e. g. 200 J)
Start	Block 1 (4 s)	Block 2 (4 s)	Refractory time (8 s)
		“The defibrillator is charging”	Ready for shock

Table A-18 Acceleration of the ECG analysis process

If the first block yields the result “Shock recommended”, the corpuls1 will immediately begin to charge energy, to reduce the amount of time from beginning of analysis to readiness to shock.

If the overall outcome is already determined after two analysis blocks with a positive result, the third will be omitted by the ECG analysis and readiness to shock will begin as soon as the device has finished charging.

The following are defined as shockable rhythms:

- Ventricular fibrillation (VF)
- Ventricular tachycardia (VT)  $f > 180$  /min

*ECG database for validation of the analysis software (Origin of the data)*

The ECG data used originate from recordings from the Creighton University Ventricular Tachyarrhythmia Database (1; 2; 3) as well as from the Massachusetts Institute of Technology – Beth Israel Hospital (MITBIH) Malignant Ventricular Arrhythmia Database (4; 5; 6). These were recorded with common patient monitors similar to the corpuls1.

*Application on validation of the analysis software (Scope of measurements)*

A total of 1816 16-s long measurements from ECG sections which constitute a representative cross-section of all ECGs have been included for validation of the analysis software. These measurements were classified by a cardiologist with regard to ECG rhythms and shockability. The threshold between an asystole and a VF was set at an amplitude of 140  $\mu$ V and the threshold between a shockable and a non-shockable VT at a heart rate of 180/min. The measurements contained in this database were not used for development. Performance goals for arrhythmia analysis algorithms (artifact free) as recommended by the American Heart Association (7).

Rhythms	Test sample size total (required minimum)	Observed performance
“Shockable”	736 (250)	
Coarse VF Amplitude > 140 $\mu$ V	591 (200)	92.22 %
Rapid VT	145 (50)	100 %
“Nonshockable”	1058 (230)	
Normal sinus rhythm (NSR)	480 (100 arbitrary)	98.75 %
Atrial fibrillation/-flutter (AF), sinus bradycardia (SB), supraventricular tachycardia (SVT), heart block, idi-oventricular, premature ventricular contractions (PVCs)	392 (30 arbitrary)	99.49 %

Rhythms	Test sample size total (required minimum)	Observed performance
Asystole	186 (100 for safety)	91.40 %

Table A-19 Classification table

(1) Goldberger AL, Amaral LAN, Glass L, Hausdorff JM, Ivanov PCh, Mark RG, Mietus JE, Moody GB, Peng C-K, Stanley HE. PhysioBank, PhysioToolkit, and PhysioNet: Components of a New Research Resource for Complex Physiologic Signals. *Circulation* 101(23):e215-e220 [Circulation Electronic Pages; <https://ahajournals.org/doi/10.1161/01.CIR.101.23.e215>; 2000 (June 13).

(2) Nolle FM, Badura FK, Catlett JM, Bowser RW, Sketch MH. CREI-GARD, a new concept in computerized arrhythmia monitoring systems. *Computers in Cardiology* 13:515-518 (1986).

(3) See <https://physionet.org/content/cudb/1.0.0/>

(4) Guidelines for cardiopulmonary resuscitation and emergency cardiac care. Emergency Cardiac Care Committee and Subcommittees, American Heart Association. *JAMA*. 1992;268:2171-2302.

(5) Greenwald SD. Development and analysis of a ventricular fibrillation detector. M.S. thesis, MIT Dept. of Electrical Engineering and Computer Science, 1986.

(6) See also <https://physionet.org/content/vfdb/1.0.0/>

(7) Kerber, Richard E. (1997): Automatic external defibrillators for public access defibrillation. Recommendations for specifying and reporting arrhythmia analysis algorithm performance, incorporating new waveforms, and enhancing safety. A Statement for Health Professionals From the American Heart Association Task Force on Automatic External Defibrillation, Subcommittee on AED Safety and Efficacy. With assistance of Lance B. Becker, Joseph D. Bourland, Richard O. Cummins, Alfred P. Hallstrom, Mary B. Michos, Graham Nichol et al. Dallas, TX: American Heart Association (Scientific statement).

*Assessment and result (Decision-making reliability of the ECG analysis programme):*

The following table refers to the ECG analysis program of the various operating modes:

- in AED mode, a therapy recommendation is issued.
- in monitoring mode, manual mode and pacing mode, a potential alarm to a shockable rhythm (ventricular fibrillation or ventricular tachycardia with  $f > 180$  /min) is issued.

Decision-making reliability of the ECG analysis programme	
Sensitivity and specificity	The quality of an ECG analysis programme is determined by the values sensitivity and specificity
Performance indicators	According to the recommendation of general guidelines, test ECGs of the <i>intermediate</i> class are not included in the calculation of sensitivity or specificity. For the evaluation of the performance of the algorithm the following performance indicators were defined: a = number of correct positive decisions b = number of false positive decisions c = number of false negative decisions d = number of correct negative decisions
Total number of measurements	1816
<b>Result</b>	<b>Value</b>
a	712
b	20

Decision-making reliability of the ECG analysis programme	
c	46
d	1038
This therefore yields: Sensitivity = $a / (a+c) = 0.9393$ ; required > 90 % according to recommendations of the general guidelines for therapy) Positive predictive value = $a / (a+b) = 0.9727$ False positive ratio = $b / (b+d) = 0.0189$ Specificity = $d / (b+d) = 0.9811$ ; required > 95 % for asystoles, according to general guidelines for therapy)	

Table A-20 Technical specifications - Decision-making reliability of the ECG analysis programme

**ECG with therapy electrodes**

ECG with therapy electrodes		
Amplifier input	corPatch electrodes; Shock spoons	Type CF insulated > 5 kV, defibrillation proof
	Shock paddles	Type BF insulated > 5 kV, defibrillation proof
Frequency input	0.05 Hz to 150 Hz (-3 dB)	
Input impedance	> 180 kΩ (DC)	
Common mode rejection (CMRR)	-44 dB	
Dynamic range	± 310 mV (signal voltage)	
Maximum electrode offset voltage	± 300 mV (input offset)	
Scanning frequency	1000 Hz	
Digital definition	4.89 μV/bit	
Maximum auxiliary current through the patient for impedance measurement DE	< 10 μA (32 kHz)	

Table A-21 Technical Specifications - ECG with therapy electrodes

**Pulse oximetry (option SpO<sub>2</sub>) SpCO, SpHb, SpMet - Manufacturer Masimo)**

Pulse oximetry - General Specifications		
Amplifier input	Typ BF, insulated > 5 kV, defibrillation-proof	
Alarm	SpO <sub>2</sub>	Lower alarm limit 65 % to 99 % Upper alarm limit 90 % to 100 %
	PR	Lower alarm limit 25 /min to 100 /min Upper alarm limit 70 /min to 200 /min
Updating frequency of display (SpO <sub>2</sub> , PR and PI)	1 Hz	
Band width	0.5 Hz to 6 Hz	
Wavelength with maximum intensity	500 nm to 1400 nm	

Pulse oximetry - General Specifications		
Radiated power of the light for the basic pulse oximetry sensor (type: LNCS and M-LNCS)	≤ 15 mW (pulsed, at 50 mA)	
Radiated power of the light for advanced oximetry option with Masimo Rainbow SET® technology	25 mW (pulsed, at 100 mA)	
Measurement range	SpO <sub>2</sub>	1 % to 100 %
	PR	25 /min to 240 /min
	PI	0.02 % to 20 %
Calibrated measurement range	SpO <sub>2</sub>	70 % to 100 %
	PR	25 /min to 240 /min
	PI	0.1 % to 20 %
Calibration	By reference measurements with fractional saturation measurement. On pulse oximetric haemoglobin oxygen saturation with dyshaemoglobin-free blood.	
Definition	SpO <sub>2</sub>	1 %
	PR	1/min
	SpCO®	1 %
	SpMet®	0.1 %
	SpHb®	0.1 g/dl
	PI	0.1 mmol/l 0.1 %
Accuracy	Oxygen saturation measurement	≤ 2 % (70 % to 100 %, static measurement)
		≤ 3 % (70 % to 100 %, measurement in motion)
		≤ 3 % (50 % to 69 %)
	Pulse rate measurement	≤ 3 /min (25 /min to 240 /min, static measurement)
		≤ 5 /min (25 /min to 240 /min, measurement in motion)
SpHb	≤ 1 g/dl	
SpHb	≤ 1 %	
SpCO	≤ 3 %	
SpO <sub>2</sub> curve	Standardised, according to EN 9919	

Table A-22 Technical specifications - Pulse oximetry, general (option SpO<sub>2</sub>, SpCO, SpHb, SpMet, Masimo Rainbow SET® Technology)



Pulse oximetry sensors are defined as surface devices with skin contact for longer contact duration (> 24 h to 30 d) as defined in ISO 10993-1 (Biological Evaluation of Medical Devices - Part 1: Guidance on the Selection of Tests). The pulse oximetry sensors that come in contact with the patient require the following biocompatibility tests: cytotoxicity, sensitisation and irritation, or intracutaneous reactivity. All materials coming into contact with patients passed (refer to M Masimo Safety Information on page 252).

### Defibrillator General

Defibrillator output		
Insulated application part with insulation voltage > 5 kV The type is determined by the kind of therapy electrodes used.	Disposable therapy electrodes, Type CF insulated	corPatch easy
		corPatch easy pre-connected
		corPatch easy Pediatric/Pediatric Extended
	Shock paddles, Type BF, insulated	Shock paddles
Baby shock electrodes The energy level is reduced at a ratio of 1:10		
	Shock spoons, type CF insulated	

Table A-23 Technical Specifications - Defibrillator Output

Conductive surface of therapy electrodes			
corPatch easy		Approx. 81 cm <sup>2</sup>	Approx. 12.46 sq in
corPatch easy pre-connected		Approx. 87 cm <sup>2</sup>	Approx. 13.38 sq in
corPatch easy Pediatric/Pediatric Extended		Approx. 42 cm <sup>2</sup>	Approx. 6.46 sq in
Shock paddles	Shock paddles for adults	53 cm <sup>2</sup>	Approx. 8.15 sq in
	Shock paddles with baby shock electrodes	16.6 cm <sup>2</sup>	Approx. 2.55 sq in
Shock spoons	Size A	11.00 cm <sup>2</sup>	Approx. 1.69 sq in
	Size B	18.25 cm <sup>2</sup>	Approx. 2.81 sq in
	Size C	46.60 cm <sup>2</sup>	Approx. 7.17 sq in

Table A-24 Technical specifications - conductive surface of therapy electrodes

Defibrillation and Cardioversion	
Charging status indicator	Indicated by the following message during the charging process: <b>Charging</b>
Ready for shock	Indicated by the message <b>Deliver shock</b> and by the ready signal. The <b>Shock</b> key is flashing red.
Delay time between R-wave and shock impulse	≤ 15 ms
Energy level display	In digits on the screen

Defibrillation and Cardioversion		
Synchronisation	Manual mode	Automatic recognition of asynchronous and synchronous defibrillation. Indicated by SYNC and ASYNC.
	AED mode	Defibrillation is always performed asynchronously. No indication of ASYNC.
Internal discharge	0.5 s after release of shock with high patient impedance	
	Manual mode	30 s after device is ready for shock, unless the user has pressed the soft-key [Cancel] in the meantime
	AED mode	30 s after the message <b>Deliver shock</b> appears
Test Defibrillator	External Testload/Testbox/corpuls simulator with 50 $\Omega$ resistance	

Table A-25 Technical Specifications - Defibrillation and cardioversion

**Biphasic defibrillator**

General Specifications		
Number of possible shocks per battery load (fully charged)	At least 200 shocks with 200 J	
AED mode	Max. time from start of ECG analysis to 'Ready for shock'.	< 12 s
	Max. time from start of ECG analysis to 'Ready for shock'. After release of 15 shocks with maximum energy.	< 12 s (no difference to fully charged battery)
	Max. time from switch on of the corpuls1 to 'Ready for shock'	< 30 s
Manual mode	corpuls1 charging time to maximum energy (with battery fully charged)	Approx. 5.5 s
	corpuls1 charging time to max. energy after release of 15 shocks	Approx. 5.5 s (no difference to fully charged battery)
	Charging time of the corpuls1 high voltage unit from switch on of the corpuls1 to max. energy	< 25 s
Impulse form	Biphasic, typical	Positive rectangular impulse 4 ms to 7 ms (90 % energy)
		Negative rectangular impulse 3 ms to 4 ms (10 % energy)
		May vary slightly depending on the impedance
Patient impedance range within which a shock can be delivered	corPatch easy electrodes	> 15 $\Omega$ to 600 $\Omega$
	Shock paddles	> 15 $\Omega$ to 600 $\Omega$
	Shock spoons	$\geq$ 1 $\Omega$ to $\leq$ 600 $\Omega$

General Specifications	
Deviation of delivered energy with an impedance of 50 Ω	≤ ± 10 %

Table A-26 Technical Specifications - Biphasic Defibrillator

The following table shows all energy levels that the user can configure via softkey context menu or in individual steps. When the energy can be selected in individual steps, the increments are the same for all types of therapy electrodes. Just the upper limit varies in different types of therapy electrodes.

The increments for individual steps for corPatch easy electrodes and shock paddles are as follows:

- 1 J
- From 4 J to 40 J in increments of 4 J.
- From 40 J to 100 J in increments of 5 J.
- From 100 J to 200 J in increments of 10 J.

The increments for individual steps for shock paddles are as follows:

- 1 J to 5 J, in increments of 1 J.
- From 5 J to 50 J in increments of 5 J.

Biphasic Defibrillator - Energy levels		
Energy levels for defibrillation and cardioversion with corPatch easy electrodes	AED mode, Patient group Adult	Softkey context menu: 100 J, 120 J, 150 J, 200 J
	AED mode, Patient group Child	Softkey context menu: 20 J, 40 J, 70 J, 100 J
	AED mode, Patient group Neonate	Softkey context menu: 12 J, 24 J, 36 J, 50 J
	Manual mode, Patient group Adult	Softkey context menu: 100 J, 120 J, 150 J, 200 J
		Individual steps: From 1 J to 200 J
	Manual mode, Patient group Child	Softkey context menu: 20 J, 40 J, 70 J, 100 J
		Individual steps: From 1 J to 100 J
	Manual mode, Patient group Neonate	Softkey context menu: 12 J, 24 J, 36 J, 50 J
		Individual steps: From 1 J to 50 J

Biphasic Defibrillator - Energy levels		
Energy levels for defibrillation and cardioversion with shock paddles	Manual mode, Patient group Adult	Softkey context menu: 100 J, 120 J, 150 J, 200 J
		Individual steps: From 1 J to 200 J
	Manual mode, Patient group Child	Softkey context menu: 20 J, 40 J, 70 J, 100 J
		Individual steps: From 1 J to 100 J
	Manual mode, Patient group Neonate NOTE: If baby shock electrodes are used, the corpuls1 automatically reduces the energy to 10 % of the selected value.	Softkey context menu: 50 J, 100 J, 150 J, 200 J
		Individual steps: From 1 J to 200 J
Energy levels for defibrillation and cardioversion with shock spoons	Manual mode, Patient group Adult	Softkey context menu: 15 J, 25 J, 35 J, 50 J
		Individual steps: From 1 J to 50 J

Table A-27 Technical Specifications - Energy Levels Biphasic Defibrillator

Following table shows the precision of the energy released for corPatch easy electrodes and shock paddles

Selected energy (in Joule)	Nominal energy released in comparison to patient impedance							Accuracy
	Load impedance (in Ohm)							
	25	50	75	100	125	150	175	
1	1.0	1.1	1.4	1.2	1.2	1.2	1.1	± 3 J
4	3.8	4.2	4.2	4.2	4.2	4.2	4.2	± 3 J
8	7.6	8.2	8.4	8.2	8.2	8.4	8.4	± 3 J
12	11.2	12.3	12.5	12.2	12.2	12.3	12.2	± 3 J
16	15.2	16.3	16.5	16.6	16.0	16.2	16.1	± 3 J
20	18.8	20.5	20.9	20.6	20.2	20.4	20.0	± 3 J
24	23.0	24.7	24.9	24.8	24.5	24.3	24.5	± 15 %
28	26.6	28.7	28.8	28.6	28.5	28.2	28.0	± 15 %
32	30.0	32.8	33.3	32.8	32.5	32.1	32.2	± 15 %
36	34.0	36.6	37.1	36.6	36.2	36.6	36.1	± 15 %
40	37.2	40.9	41.1	40.8	40.2	40.5	40.2	± 15 %
45	41.8	45.8	46.4	45.8	45.0	45.6	45.1	± 15 %
50	46.2	50.6	51.5	50.6	50.2	50.7	50.1	± 15 %
55	50.8	55.2	56.3	55.8	55.0	55.5	55.0	± 15 %
60	55.2	60.9	61.1	60.8	60.2	60.3	59.9	± 15 %
65	60.2	65.6	66.8	65.8	65.7	65.1	64.8	± 15 %



Selected energy (in Joule)	Nominal energy released in comparison to patient impedance							Accuracy
	Load impedance (in Ohm)							
	25	50	75	100	125	150	175	
70	64.8	70.6	71.4	70.8	70.5	69.9	69.3	± 15 %
75	69.0	75.5	77.0	76.0	75.5	75.0	74.6	± 15 %
80	72.8	80.3	81.5	80.8	80.5	80.1	79.5	± 15 %
85	77.8	85.5	86.3	85.8	85.5	84.9	84.0	± 15 %
90	82.8	90.4	91.2	90.4	90.2	90.0	90.0	± 15 %
95	87.0	95.2	95.9	95.8	95.5	94.8	94.9	± 15 %
100	91.8	100.3	101.4	100.4	100.2	99.6	98.7	± 15 %
110	100.4	110.2	111.2	110.2	110.2	111.0	109.9	± 15 %
120	109.4	120.1	121.7	120.6	120.5	121.2	120.1	± 15 %
130	118.2	130.3	131.7	130.6	130.2	129.6	139.9	± 15 %
140	127.8	139.3	141.8	140.8	140.0	141.6	139.7	± 15 %
150	135.8	149.9	152.0	150.6	149.7	151.2	149.8	± 15 %
160	145.0	159.6	161.9	160.8	160.0	161.4	158.6	± 15 %
170	154.4	169.6	171.0	170.0	169.5	170.4	167.3	± 15 %
180	163.0	179.1	181.8	180.2	180.0	179.4	175.7	± 15 %
190	171.6	189.7	192.2	190.0	190.0	188.1	183.8	± 15 %
200	180.0	199.8	203.7	200.4	199.5	198.3	191.8	± 15 %

Table A-28 Technical specifications - Precision of the energy released for corPatch easy electrodes and shock paddles

The following table shows the precision of the energy released for shock spoons.

Selected energy (in Joule)	Nominal energy released in comparison to patient impedance							Accuracy
	Load impedance (in Ohm)							
	10	15	20	25	50	100	150	
2	1.5	1.5	1.7	1.7	2.2	2.1	2.0	± 3 J
5	4.0	4.2	4.5	4.9	5.6	5.5	5.2	± 3 J
10	8.8	9.2	9.0	9.2	11.2	11	10.2	± 15 %
20	18.1	19.4	20.2	20.8	22.8	23.7	22.6	± 15 %
30	26.4	28.6	29.5	31.3	34.5	23.4	32.7	± 15 %
40	36.8	37.7	39.8	40.8	45.9	45.8	43.3	± 15 %
50	46.3	49.6	49.2	51.2	57.7	56.1	54.7	± 15 %

Table A-29 Technical specifications - precision of the energy released for corPatch easy therapy electrodes

The following illustration shows the biphasic shock impulse with 200 J at different patient impedances. The waveform of the shockwave is comprised of a positive rectangular waveform (4 ms to 7 ms duration) and a negative rectangular waveform (3 ms to 4 ms). The positive rectangular waveform is 90 %, the negative rectangular waveform 10 % of the total

energy. The amplitude and the duration of the rectangular waveforms are adjusted automatically to the patient's impedance.

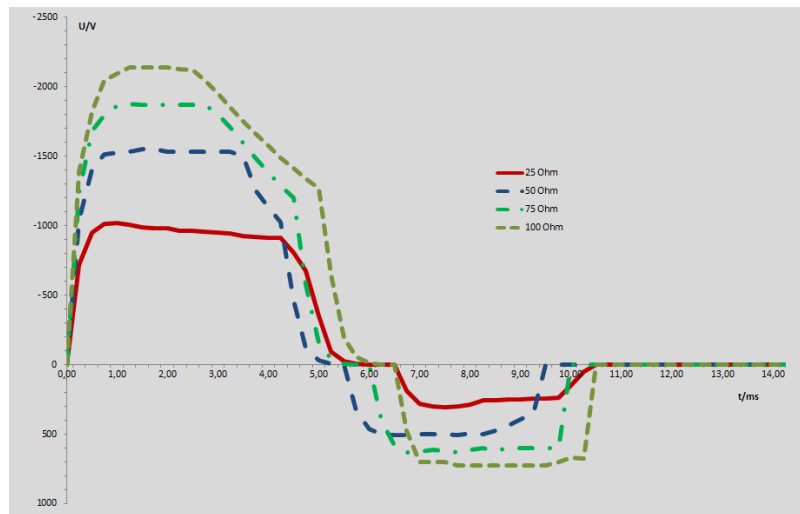

Figure A-1 Biphasic shockwave - impedances of 25 Ohm to 100 Ohm

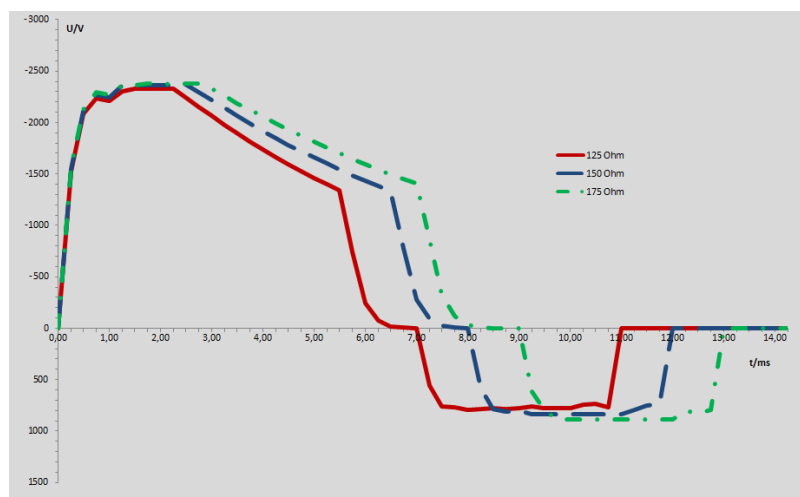

Figure A-2 Biphasic shockwave - impedances of 125 Ohm to 175 Ohm

**Pacer (Option)**

Pacer - General Specifications	
Modes	FIX mode DEMAND mode
Output	Application part Type BF, insulated > 5 kV
Pacing frequency (FIX- and DEMAND mode)	From 30 /min to 180 /min, in increments of 5 /min
Intensity of the pacer pulse (FIX- and DEMAND mode)	From 10 mA to 150 mA in increments of 5 mA
Impulse duration	40 ms (Rectangular impulse)

Table A-30 Technical Specifications - Pacer, general

**corPatch CPR disposable sensor (option)**

corPatch CPR - general data		
Amplifier input	Type BF insulated > 5 kV, defibrillation-proof	
Function principle (sensor)	Acceleration sensor	
Displayed parameters	Combined curve for display of compression depth and compression frequency	
	CPR rate (compression rate)	
Measurement range	70 to 150 compressions/min	
Measurement range	1.9 cm to 10.16 cm	0.75 in to 4.0 in
Measurement interval	Continuous	
Operating temperature (sensor)	-20 °C to +60 °C	-28.9 °F to +140 °F
Storage temperature (sensor)	-30 °C to +65 °C	-22 °F to +149 °F
Relative humidity (sensor)	≤93 % (without condensation)	
Storage humidity (sensor)	≤93 % (without condensation)	
Sensor dimensions (Height x Width with foam padding)	101 mm x 64 mm	4.0 in x 2.5 in
Sensor weight (with cable)	50.2 g	
Sensor weight (without cable)	28.8 g	
Accuracy	±3 compressions/min	
Accuracy	±0.635 cm	±0.25 in

Table A-31 Technical specifications - general corPatch CPR

**Charging bracket and the adapter charging bracket (accessories)**

Dimensions		
Height	20 cm	7.87 in
Width	23 cm	9.06 in
Depth	7 cm	2.76 in
	Adapter charging bracket: 9.5 cm	Adapter charging bracket: 3.74 in

Table A-32 Technical Specifications - Dimensions of charging brackets

Environmental requirements		
Environmental temperature	-20 °C to +55 °C	-4 °F to +131 °F
Relative humidity	≤95 % (without condensation)	
Protection	IPx2	

Table A-33 Technical Specifications Charging brackets - Environmental requirements

Storage conditions		
Storage temperature	-20 °C to +65 °C	-4 °F to +149 °F

Table A-34 Technical Specifications Charging brackets - Storage conditions

Energy Management		
External power supply, On-board power supply 12 V	Approved input voltage range	≥ 10 V
		Typical 12 V
		≤ 14 V
	Protection	15 A, time lag fuse (T) Additional consumers on-board not taken into account
AC adapter corpuls3/corpuls1	Output current, maximum	9 A
	Protection	6.3 A, time lag fuse (T)
	Range of output voltage	≥ 10 V
		Typical 12 V
		≤ 14 V
	Protection class against electrical shock when operated via mains charger (according to IEC 60601-1)	I

Table A-35 Technical Specifications Charging brackets - Energy Management

## I Major Performance Characteristics

The essential performance characteristics of the corpuls1 and its optional accessories are:

- Defibrillation, synchronous cardioversion and AED therapy decision
- ECG monitoring, heart rate and alarms
- SpO2 monitoring, pulse rate and alarms
- Mounting in vehicle

## J Guidelines and Manufacturer's Declaration

Electromagnetic emission		
The corpuls1 is intended for operation in the electromagnetic environment indicated below. The operator or the user must ensure that the corpuls1 is used in such an environment.		
Emission measurements	Compliance	Electromagnetic environment - guidelines
HF emissions according to CISPR 11	Group 1 Class B	The corpuls1 uses HF energy only for its internal function. The HF emission is very low. Therefore the risk of the corpuls1 impairing the function of adjacent electronic devices is unlikely.  According to IEC 60601-1-2, the corpuls1 is intended for use in areas of home health care and in professional healthcare institutions and those which are directly connected to the public mains supply. Furthermore, the corpuls1 is suitable for use in vehicles, aeroplanes and on ships.
HF emissions according to CISPR 25	ECE R-10	
Emission of harmonic oscillations according to IEC 61000-3-2	Only to be used with tabletop AC adapter, class A	
Voltage fluctuations/flicker according to IEC 61000-3-3	Only to be used with tabletop AC adapter	

Table A-36 Electromagnetic emission

Electromagnetic interference immunity			
The corpuls1 is intended for operation in the electromagnetic environment indicated below. The operator or the user must ensure that the corpuls1 is used in such an environment.			
Interference immunity tests	IEC 60601 test level	Compliance level	Electromagnetic environment - guidelines
Transient electrical interference/bursts at supply cables in accordance with ISO 7637-2	Pulses 1, 2, 3, 4 limit according to ECE R-10 and EN 50498	Test Level III	
Electrostatic discharge (ESD) according to IEC 61000-4-2	± 8 kV contact discharge ± 15 kV aerial discharge	± 8 kV contact discharge ± 15 kV aerial discharge	Floors should be made of wood, concrete or metal or be covered with ceramic tiles. If the floor is covered with synthetic material, the relative humidity should be at least 30 %.
Rapid transient electrical interference/bursts according to IEC 61000-4-4	± 2 kV for mains leads ± 1 kV for Signal Input Parts (SIPS)/Signal Output Parts (SOPS)	± 2 kV for mains leads ± 1 kV for Signal Input Parts (SIPS)/Signal Output Parts (SOPS)	The quality of the power supply should correspond to that of a typical business or hospital environment.
Surges according to IEC 61000-4-5	± 1 kV line to line ± 2 kV line to ground	± 1 kV line to line ± 2 kV line to ground	The quality of the power supply should correspond to that of a typical business or hospital environment.
Voltage dips, brief interruptions and fluctuations in the power supply according to IEC 61000-4-11 NOTE: Only to be used with tabletop AC adapter	0 % $U_T$ for ½ period 40 % $U_T$ for 6 periods 70 % $U_T$ for 30 periods 0 % $U_T$ for 300 periods	0 % $U_T$ for ½ period 40 % $U_T$ for 6 periods 70 % $U_T$ for 30 periods 0 % $U_T$ for 300 periods	The corpuls1 is always operated with a battery buffer. The user must make sure that the battery in the device is always adequately charged.
Magnetic field of the supply frequency (50/60 Hz) in accordance with IEC 61000-4-8	30 A/m	30 A/m 50 Hz	Do not operate the corpuls1 near an activated MRI unit (magnetic resonance imaging).
<i>Note:</i> $U_T$ is the mains alternating voltage before application of the test level.			

Table A-37 Electromagnetic interference immunity part 1

Electromagnetic interference immunity			
The corpuls1 is intended for operation in the electromagnetic environment indicated below. The operator or the user must ensure that the corpuls1 is used in such an environment.			
Interference immunity tests	IEC 60601 test level	Compliance level	Electromagnetic environment - guidelines
Conducted HF interference in accordance with IEC 61000-4-6	3 V <sub>eff</sub> outside the ISM- and amateur radio frequency bands <sup>a</sup>	3 V <sub>eff</sub> outside the ISM- and amateur radio frequency bands <sup>a</sup>	d = 1.2√P
	6 V <sub>eff</sub> inside the ISM- and amateur radio frequency bands <sup>a</sup>	6 V <sub>eff</sub> inside the ISM- and amateur radio frequency bands <sup>a</sup>	
Radiated HF interference according to IEC 61000-4-3	10 V/m 80 MHz to 2.5 GHz	3 V/m	ECG monitor: d = 4.0√P for 80 MHz to 800 MHz d = 7.7√P for 800 MHz to 2.5 GHz
		20 V/m	Oximetry monitor: d = 4.0√P for 80 MHz to 800 MHz d = 7.7√P for 800 MHz to 2.5 GHz
		10 V/m	Defibrillator: no unintentional change in condition d = 1.2√P for 80 MHz to 800 MHz d = 2.3√P for 800 MHz to 2.5 GHz
		20 V/m	Defibrillator: no unintentional energy release d = 0.6√P for 80 MHz to 800 MHz d = 1.2√P for 800 MHz to 2.5 GHz P being the maximum nominal output of the transmitter in watts (W) in accordance with the transmitter manufacturer's specifications and d being the recommended protection distance in metres (m). <sup>b</sup> The field strength of stationary radio transmitters should be lower than the ambient level <sup>c</sup> for all frequencies according to an on-site test. <sup>d</sup> Interference is possible in the vicinity of devices that bear the following pictorial symbol: 



Electromagnetic interference immunity
<p><b>Comment 1</b> At 80 MHz and 800 MHz the higher frequency range applies.</p> <p><b>Comment 2</b> These guidelines may not be applicable in all cases. Propagation of electromagnetic variables is influenced by absorption and reflection of the buildings, objects and people.</p> <p><sup>a</sup> The ISM frequency bands (for industrial, scientific and medical applications between 150 kHz and 80 MHz) are 6.765 MHz to 6.795 MHz; 13.553 MHz to 13.567 MHz; 26.957 MHz to 27.283 MHz and 40.66 MHz to 40.70 MHz.</p> <p><sup>b</sup> The compliance levels in the ISM frequency bands between 150 kHz and 80 MHz and in the frequency range of 80 MHz and 2.5 GHz are intended to reduce the likelihood that portable/mobile communication devices will be able to cause interference if they are unintentionally brought into the patient area. For this reason, the additional factor 10/3 is applied in calculating the recommended protection distances in these frequency ranges.</p> <p><sup>c</sup> It is theoretically not possible to precisely determine in advance the field strength of stationary transmitters such as e. g. base stations of mobile telephones and mobile terrestrial radio devices, amateur radio stations, and AM and FM radio and television transmitters. To establish the electromagnetic environment with regard to stationary transmitters, a study of the location should be considered. If the measured field strength at the location at which the device is used exceeds the above mentioned compliance level, the device must be observed to verify function as intended. If unusual performance characteristics are observed, additional measures may be required, such as e. g. a modified orientation or another location for the device.</p> <p><sup>d</sup> Above the frequency range of 150 kHz to 80 MHz the field strength must be less than 3 V/m.</p>

Table A-38 Electromagnetic interference immunity part 2

Electromagnetic interference immunity			
The corpuls1 is intended for operation in the electromagnetic environment indicated below. The operator or the user must ensure that the corpuls1 is used in such an environment.			
Interference immunity tests	IEC 60601 test level	Compliance level	Electromagnetic environment - guidelines

Electromagnetic interference immunity			
Radiated HF interference according to IEC 61000-4-3	27 V/m	27 V/m	380 MHz to 390 MHz TETRA 400
	28 V/m	28 V/m	430 MHz to 470 MHz GMRS 460, FRS 460
	9 V/m	9 V/m	704 MHz to 787 MHz LTE Band 13, 17
	28 V/m	28 V/m	800 MHz to 960 MHz GSM 800/900, TETRA 800, iDEN 820, CDMA 850, LTE Band 5
	28 V/m	28 V/m	1700 MHz to 1990 MHz GSM 1800, CDMA 1900, GSM 1900, DECT, LTE Band 1, 3, 4, 25; UMTS
	28 V/m	28 V/m	2400 MHz to 2570 MHz Bluetooth, WLAN 802.11 b/g/n, RFID 2450, LTE Band 7
	9 V/m	9 V/m	5100 MHz to 5800 MHz WLAN 802.11 a/n





























Table A-39 Electromagnetic interference immunity part 2

Recommended protection distances between portable/mobile HF communication devices and the corpuls1				
The corpuls1 is intended for operation in an electromagnetic environment in which radiated HF interference is controlled. The operator or the user of the corpuls1 can help to prevent electromagnetic interference by observing minimum distances between portable/mobile HF communication devices (transmitters) and the corpuls1 as recommended below in accordance with the maximum output of the communication device.				
Nominal output of the transmitter in W	Protection distance in accordance with transmission frequency in m			
	150 kHz to 80 MHz outside the ISM bands $d = 1.2\sqrt{P}$	150 kHz to 80 MHz in the ISM bands $d = 4.0\sqrt{P}$	When used as a monitor	
			80 MHz to 800 MHz $d = 4.0\sqrt{P}$	800 MHz to 2.5 GHz $d = 7.7\sqrt{P}$
0.01	0.12	0.40	0.40	0.77
0.1	0.38	1.3	1.3	2.4
1	1.2	4.0	4.0	7.7
10	3.8	13	13	24
100	12	40	40	77
	When used as a defibrillator		Defibrillator: no unintentional energy release	
	80 MHz to 800 MHz $d = 1.2\sqrt{P}$	800 MHz to 2.5 GHz $d = 2.7\sqrt{P}$	80 MHz to 800 MHz $d = 0.6\sqrt{P}$	800 MHz to 2.5 GHz $d = 1.2\sqrt{P}$
0.01	0.12	0.27	0.06	0.12
0.1	0.38	0.66	0.15	0.38
1	1.2	2.7	0.6	1.2

Recommended protection distances between portable/mobile HF communication devices and the corpuls1				
10	3.8	6.6	1.5	3.8
100	12	27	6.0	12
<p>For transmitters, whose nominal output is not indicated in the table above, the distance can be determined using the equation which corresponds to the respective column. P is the nominal output of the transmitter in watts (W) in accordance with the transmitter manufacturer's specification.</p> <p><b>Comment 1</b> The ISM bands between 150 kHz and 80 MHz are 6.765 MHz to 6.795 MHz; 13.553 MHz to 13.567 MHz; 26.957 MHz to 27.283 MHz and 40.66 MHz to 40.70 MHz.</p> <p><b>Comment 2</b> To calculate the recommended protection distance of transmitters in the ISM frequency bands between 150 kHz and 80 MHz and in the frequency range between 80 MHz to 2.5 GHz an additional factor of 10/3 is used to reduce the likelihood that a portable/mobile communications device brought into the patient area will result in interference.</p> <p><b>Comment 3</b> These guidelines may not apply in all situations. Propagation of electromagnetic waves is influenced by absorptions and reflections of buildings, objects and people. All rights reserved for technical modifications.</p>				

Table A-40 Recommended protection distances

## K Reset to Factory Settings

Menu item "Alarms"	Submenu item	List	List box	Value	
	▶ "Limits" (Adult, Child, Neonate)	<i>HR 1/min</i>		50	
				120	
		<i>SpO<sub>2</sub> %</i>		90	
				off	
		<i>PI %</i>		off	
				off	
		<i>PR 1/min</i>		50	
				120	
		<i>SpCO %</i>		off	
				10	
		<i>SpHb g/dl</i>		10.0	
				17.0	
		<i>SpMet %</i>		off	
				3	
		▶ "Auto Limits" (Adult)	<i>HR 1/min</i>		50
					120
			<i>SpO<sub>2</sub> %</i>		90
					off
	<i>PI %</i>			off	
				off	
	<i>PR 1/min</i>			50	
				120	
	<i>SpCO %</i>			off	
				10	
<i>SpHb g/dl</i>			10.0		
			17.0		
<i>SpMet %</i>			off		
			3		

Submenu item	List	List box	Value
▶ "Settings"	<i>Settings</i> (user OPERATOR only)	<i>Suspension</i>	<i>off</i>
		<i>Reminder</i>	<input checked="" type="checkbox"/>
		<i>Silence</i>	Not active
	Alarm	<i>Volume</i>	5

Table A-41 Factory Settings - Alarms

Menu item  
"Signals"

Submenu item	List	List box	Settings value
▶ "Curves"	<i>ECG</i>	<i>DE</i>	<input type="checkbox"/>
		<i>I</i>	<input type="checkbox"/>
		<i>II</i>	<input type="checkbox"/>
		<i>Auto II/DE</i>	<input checked="" type="checkbox"/>
		<i>III</i>	<input type="checkbox"/>
		<i>aVR</i>	<input type="checkbox"/>
		<i>aVL</i>	<input type="checkbox"/>
		<i>aVF</i>	<input type="checkbox"/>
		<i>-aVR</i>	<input type="checkbox"/>
		<i>Oximetry</i>	<i>Pleth</i>
	<i>CPR</i>	<i>CPR</i>	<input type="checkbox"/>
▶ "Parameter"	<i>ECG</i>	<i>HR</i>	<input checked="" type="checkbox"/>
	<i>Oximetry</i>	<i>SpO<sub>2</sub></i>	<input checked="" type="checkbox"/>
		<i>PR</i>	<input type="checkbox"/>
		<i>PI</i>	<input type="checkbox"/>
		<i>SpCO</i>	<input type="checkbox"/>
		<i>SpHb</i>	<input type="checkbox"/>
		<i>SpMet</i>	<input type="checkbox"/>
	<i>Display</i>	<i>Position</i>	Left
	<i>Trend</i>	<i>Interval</i>	10 s
<i>CPR</i>	<i>CPR rate</i>	<input type="checkbox"/>	

Submenu item	List	List box	Settings value
▶ "Views"	<i>View 1</i>	-	Curves: <i>ECG (DEauto), Pleth</i> Param.: <i>HR, SpO<sub>2</sub>, PR, PI</i> Position: <i>at the top</i>
	<i>View 2</i>	-	Curves: <i>ECG (DEauto), Pleth</i> Param.: <i>HR, SpO<sub>2</sub></i> Position: <i>right</i>
	<i>View 3</i>	-	Curves: <i>ECG (DEauto), Pleth</i> Param.: <i>HR, SpO<sub>2</sub></i> Position: <i>left</i>
	<i>View 4</i>	-	Curves: <i>ECG (DEauto), Pleth</i> Param.: <i>HR, SpO<sub>2</sub>, PI</i> Position: <i>left</i>

Table A-42 Factory Settings - Signals

Menu item  
"ECG"

Submenu item	List	List box	Settings value
▶ "Settings"	<i>Display</i>	<i>Speed</i>	25 mm/s
		<i>Amplitude</i>	x1
		<i>QRS Marker</i>	<input checked="" type="checkbox"/>
	<i>QRS Tone</i>	<i>Enabled</i>	<input checked="" type="checkbox"/>
		<i>Dynamic</i>	<input type="checkbox"/>
		<i>Volume</i>	4
▶ "Filter" (user OPERATOR only)	<i>Filter</i>	<i>Low pass</i>	25 Hz
		<i>High pass</i>	0.5 Hz

Table A-43 Factory Settings - ECG

Menu item "Defib"	Submenu item	List	List box	Settings value
	▶ "Settings"	Audio	Record	<input type="checkbox"/>
		Starting mode	Man. Defib.	<input type="checkbox"/>
	▶ "Metronome"	Audio	Compr. tone	10
			Vent. tone	10
		Autostart metr.	AED	off
			Man. Defib	off
		Adult (user OPERATOR only)	Compress.	100 /min
			Vent. 30:2	4 s
		Child (user OPERATOR only)	Compress.	100 /min
			Vent. 15:2	4 s
			Vent. 30:2	4 s
		▶ "AED" (user OPERATOR only)	Audio AAM	AAM
View	VP		none	
	Additional Curve		III	
Pre-shock CPR	Compressions		none	
	Metronome		<input type="checkbox"/>	
Algorithm	CPR		120 s	
Auto Energy	Adult		200 J	
	Child		100 J	
	Neonate		50 J	
	Locked		<input checked="" type="checkbox"/>	
▶ "Manual" (user OPERATOR only)	Audio	Ready-signal	<input checked="" type="checkbox"/>	
	View	VP	HR	
		Additional Curve	III	
	Auto Energy	Adult	200 J	
		Child	100 J	
		Neonate	50 J	
▶ "CPR"	Audio AAM	Feedback AED	10	
		Feedback Manual	10	
		Feedback Moni- tor	10	
		Fully release	<input checked="" type="checkbox"/>	
	Application note	Show note	<input checked="" type="checkbox"/>	
	CPR depth	Unit	cm	

Table A-44 Factory Settings - Defib



The CPR compression depth is fixedly implemented and therefore corresponds to the factory settings:

5.0 cm to 6.0 cm / 2.0 in to 2.4 in

**Menu item**  
"Pacer"

Menu item	List	List box	Value
"Pacer"	<i>View</i>	<i>VP</i>	<i>HR</i>
		<i>Additional Curve</i>	<i>III</i>

Table A-45 Factory Settings - Pacer

**Menu item**  
"Oximetry"

Submenu item	List	List box	Value
▶ "Settings"	<i>Display</i>	<i>Speed</i>	25 mm/s
	<i>Settings</i>	<i>FastSat</i>	<input type="checkbox"/>
		<i>Averaging time</i>	8 s
		<i>Sensitivity</i>	<i>Normal</i>
	<i>Pulse tone</i>	<i>Enabled</i>	<input checked="" type="checkbox"/>
		<i>Dynamic</i>	<input type="checkbox"/>
		<i>Volume</i>	4
	<i>SpHb</i>	<i>Unit</i>	<i>g/dl</i>

Table A-46 Factory Settings - Oximetry

**Menu item**  
"System"

Submenu item	List	List box	Settings value
▶ "Settings"	<i>Language</i> (user OPERATOR only)	-	<i>English</i>
	<i>Mains filter</i> (user OPERATOR only)	<i>Mains freq.</i>	50 Hz
	<i>Display</i>	<i>Brightness</i>	8
		<i>Dim mode</i>	6
		<i>autoDim</i>	10 min
		<i>Colours</i>	<i>Default</i>
	<i>Keys</i>	<i>Backlight</i>	<input checked="" type="checkbox"/>
	<i>Device start</i> (user OPERATOR only)	<i>Mode</i>	<i>Monitoring</i>
		<i>Patient class</i>	<i>Adult</i>
		<i>Start user</i>	<i>Man. Defib</i>

Table A-47 Factory Settings - System



## L Checklist Functional test

The checklist contains the test procedures of the daily functional check (refer to 15.3 Functional Test on page 166). The checklist is meant as a tool to document the daily functional check and as a suggested complement for the local documentation.

The daily functional test is considered a pass, if the correct result has been obtained with all functional tests. If the functional check has been successful, mark the column "✓/✗" with ✓. If the functional check has failed, mark the column "✓/✗" with ✗. If necessary, there is some space for remarks at the end of the checklist.

Checklist Functional test			
Date:		Performed by:	
Shift:		Device name/serial number and software version:	
Location or department:			
Rescue equipment:			
Visual check	✓/✗	Visual check	✓/✗
corPatch easy electrodes (disposable) present and not expired		corPatch CPR disposable sensor and CPR intermediate cable present and not expired	
ECG cables (4-pole)		Shock paddles (in reserve)	
Pulse oximetry sensor and intermediate cable present and not expired			
Functional test	✓/✗	Functional test	✓/✗
Switch on the corpuls1.		corPatch CPR feedback	
Self test switch on		SD card	
Defibrillator/pacer (Shock with Testload or Testbox or corpuls simulator)		Battery	
ECG Monitoring (Testbox or corpuls simulator)		Switch off the corpuls1.	
Pulse oximetry monitoring			
Remarks			

Table A-48 Checklist Functional test

## M Masimo Safety Information

### Sensor general

- This equipment has been tested and found to comply with the limits for medical devices to the EN 60601-1-2: 2002, Medical Device Directive 93/42/EEC. These limits are designed to provide reasonable protection against harmful interference in a typical medical installation. This equipment generates, uses and can radiate radio frequency energy and, if not installed and used in accordance with the instructions, may cause harmful interference to other devices in the vicinity. However, there is no guarantee that interference will not occur in a particular installation. If this equipment does cause harmful interference to other devices, which can be determined by turning the equipment off and on, the user is encouraged to try to correct the interference by one or more of the following measures:
  - Reorient or relocate the receiving device.
  - Increase the distance between the devices.
  - Consult the manufacturer for help.
- Before use, carefully read the user manual of the sensor.
- Do not use damaged sensors or patient cables. Do not use a sensor or patient cable with exposed optical or electrical components.
- Do not attempt to reprocess, recondition or recycle any Masimo sensors or patient cables as these processes may damage the electrical components, potentially leading to harm.
- Do not modify or alter the sensor in any way. Alterations or modification may affect performance and/or accuracy.
- Unless otherwise specified, do not sterilise sensors or patient cables by irradiation, steam, autoclave or ethylene oxide. See the cleaning instructions in the user manual for the Masimo re-useable sensors.
- Interfering Substances: Dyes, or any substance containing dyes that change usual blood pigmentation may cause erroneous readings.
- To avoid cross contamination only use Masimo single use sensors on the same patient.
- The Masimo SET Technology with Masimo sensors has been validated for no motion accuracy in human blood studies on healthy adult male and female volunteers with light to dark skin pigmentation in induced hypoxia studies in the range of 70-100% SpO<sub>2</sub> against a laboratory CO oximeter and ECG monitor. This variation equals  $\pm 1$  standard deviation and encompasses 68% of the population.
- The Masimo SET Technology with Masimo sensors has been validated for motion accuracy in human blood studies on healthy adult male and female volunteers with light to dark skin pigmentation in induced hypoxia studies in the range of 70-100% SpO<sub>2</sub> against a laboratory CO oximeter and ECG monitor. Rubbing and tapping motions were performed at 2 to 4 Hz at an amplitude of 1 to 2 cm and a non-repetitive motion between 1 to 5 Hz at an amplitude of 2 to 3 cm. This variation equals  $\pm 1$  standard deviation and encompasses 68% of the population.
- The Masimo SET technology has been validated for low perfusion accuracy in bench top testing against a Biotek Index 2 simulator and Masimo's simulator with signal strengths of greater than 0.02% and transmission of greater than 5% for saturations ranging from 70 to 100%. This variation equals  $\pm 1$  standard deviation and encompasses 68% of the population.
- The Masimo SET technology with Masimo sensors has been validated for pulse rate accuracy for the range of 25 - 240 bpm in bench top testing against a Biotek Index 2 simulator.

This variation equals  $\pm 1$  standard deviation and encompasses 68% of the population.

- SpHb accuracy has been validated on healthy adult male and female volunteers and on surgical patients with light to dark skin pigmentation in the range of 8-17 g/dl SpHb against a laboratory CO-oximeter. This variation equals  $\pm 1$  standard deviation and encompasses 68% of the population. The SpHb accuracy has not been validated with motion or low perfusion.

#### Placement Sensor

- Tissue damage can be caused by incorrect application or use of a sensor, e. g. by wrapping the sensor too tightly. Inspect the measuring site as directed in the user manual of the sensor to ensure skin integrity and correct positioning and adhesion of the sensor.
- Avoid placing the sensor on any extremity with an arterial catheter or blood pressure cuff.
- Exercise caution when applying a sensor to a measuring site with compromised skin integrity. Applying tape or pressure to such a site may reduce circulation and/or cause further skin deterioration.
- Do not use tape to fasten the sensor at the measuring site. Can impair perfusion and lead to inaccurate readings. Use of additional tape can cause skin damage or damage the sensor.
- If the sensor is wrapped too tightly or supplemental tape is used, venous congestion/pulsations may occur causing erroneous readings.
- Circulation distal to the measuring site should be checked routinely.

#### Selecting vital parameters

- Pulse rate measurement is based on the optical detection of a peripheral flow pulse and therefore may not detect certain arrhythmias. The pulse oximeter should not be used as a replacement or substitute for ECG based arrhythmia analysis.
- The pulsations from intra-aortic balloon support can be additive to the pulse rate on the pulse oximeter pulse rate display. Verify patient's pulse rate against the ECG heart rate.
- Venous pulsations may cause erroneous low readings e. g. in case of tricuspid valve regurgitation.
- Loss of pulse signal can occur when:
  - The sensor is too tight.
  - The patient has hypotension, severe vasoconstriction, severe anaemia, or hypothermia.
  - There is arterial occlusion proximal to the sensor.
  - The patient is in cardiac arrest or is in shock.
- Venous congestion may cause under reading of actual arterial oxygen saturation. Assure proper venous outflow from measuring site. Sensor should not be located below heart level, e. g. sensor on hand of a patient in a bed with arm dangling to the floor.
- A pulse CO-Oximeter should be considered an early warning device. If a trend towards patient hypoxaemia is indicated, blood samples should be analysed by laboratory instruments to completely understand the patient's condition.
- For measurements of high or low SpHb readings, blood samples should be analysed by laboratory instruments to completely understand the patient's condition.
- SpO<sub>2</sub> is empirically calibrated to functional arterial oxygen saturation in healthy adult volunteers with normal levels of carboxyhaemoglobin (COHb) and methaemoglobin (MetHb). A pulse oximeter cannot measure elevated levels of carboxyhaemoglobin (COHb) or methaemoglobin (MetHb). Increases in either carboxyhaemoglobin- (COHb) or methaemoglobin- (MetHb) levels will affect the accuracy of the SpO<sub>2</sub> measurement.
  - For increased COHb: COHb levels above normal tend to increase the level of SpO<sub>2</sub>. The

level of increase is approximately equal to the amount of COHb that is present. High levels of COHb may occur with a seemingly normal SpO<sub>2</sub> levels. When elevated levels of COHb are suspected, laboratory analysis (CO-Oximetry) of a blood sample should be performed.

- For increased MethHb: the SpO<sub>2</sub> levels may be decreased by levels of MethHb of up to approx. 10 % to 15 %. At higher levels of MethHb, the SpO<sub>2</sub> level may tend to read in the low to mid 80s. When elevated levels of MethHb are suspected, laboratory analysis (CO-Oximetry) of a blood sample should be performed.
- Haemoglobin synthesis disorders may cause erroneous SpHb readings.
- Elevated levels of Total Bilirubin may lead to inaccurate readings of SpO<sub>2</sub>-, SpMet, SpCO, SpHb, and SpOC.
- Motion artifacts may lead to inaccurate readings of SpMet, SpCO, SpHb, and SpOC.
- Severe anaemia may cause faulty SpO<sub>2</sub> readings.
- Very low readings of arterial oxygen saturation (SpO<sub>2</sub>) may cause inaccurate readings of SpCO and SpMet.
- With very low perfusion at the measuring site, the readings may read lower than core arterial oxygen saturation.
- Misapplied sensors or sensors that are partially dislodged may cause either false-elevated or false-reduced readings of the actual arterial oxygen saturation.
- High-intensity extreme lights (including pulsating strobe lights) directed on the sensor may not allow the CO-pulse oximeter to obtain readings.
- The CO-pulse oximeter can be used during defibrillation, but the readings may be inaccurate for up to 20 s.
- The CO-pulse oximeter is NOT intended for use as an apnea monitor.
- If using CO-pulse oximetry during full body irradiation, keep the sensor out of the irradiation field. If the sensor is exposed to the irradiation, the reading might be inaccurate or the unit might read zero for the duration of the active irradiation period.
- A functional tester cannot be utilised to assess the accuracy of the pulse CO-Oximeter or any sensors.

## N List of Tables

Table 3-1	Typographic Conventions.....	7
Table 3-2	Symbols.....	11
Table 4-1	Warning- and Notice Labels on the Device.....	15
Table 5-1	Display and operating elements.....	22
Table 5-2	Indication of alarm priorities by means of alarm history and alarm light....	24
Table 7-1	Elements of the user interface in monitoring mode .....	35
Table 7-2	Overview main menu.....	36
Table 7-3	Overview parameter- and curve context menu.....	38
Table 7-4	Overview Vital parameter context menu.....	39
Table 7-5	Overview Curve context menu.....	42
Table 7-6	Overview Alarm history.....	50
Table 8-1	Elements of the user interface in defibrillation mode .....	52
Table 9-1	Elements of the user interface in pacer mode .....	57
Table 10-1	Colour coding of the clips of the ECG monitoring cable.....	62
Table 10-2	Pulse oximetry measuring options .....	65
Table 11-1	Overview Therapy Electrodes .....	75
Table 11-2	Overview AED Mode .....	81
Table 11-3	Overview Manual Mode .....	84
Table 11-4	Status of <b>STIM</b> message.....	92
Table 11-5	Overview Pacer mode.....	93
Table 11-6	Overview Metronome Settings.....	97
Table 13-1	Overview User interface elements .....	113
Table 13-2	Limits - List Alarm limits .....	116
Table 13-3	Settings Alarms - List Alarms.....	118
Table 13-4	Settings Curves - List ECG .....	119
Table 13-5	Settings Curves - List Oximetry.....	119
Table 13-6	Settings Curves - List CPR .....	119
Table 13-7	Settings Vital parameters - List ECG .....	120
Table 13-8	Settings Vital parameters - List Oximetry .....	121
Table 13-9	Settings Vital parameters - List Display.....	121
Table 13-10	Settings Vital parameters - List Trend.....	121
Table 13-11	Settings Vital parameters - List CPR .....	121
Table 13-12	ECG Settings - List Display.....	124
Table 13-13	ECG Settings - List QRS tone.....	124
Table 13-14	Settings Metronome - List Audio.....	125
Table 13-15	Settings corPatch CPR - List Application note.....	126
Table 13-16	Settings Pulse oximetry - List Display.....	127
Table 13-17	Settings Pulse oximetry - List Settings .....	128
Table 13-18	Settings Pulse oximetry - List Pulse tone.....	128

Table 13-19	Settings Pulse oximetry - List SpHb.....	129
Table 13-20	System settings (1) - List Time/Date.....	134
Table 13-21	System settings (2) - List Display.....	135
Table 13-22	System settings (2) - List Keys.....	135
Table 14-1	Settings Alarms (user OPERATOR) - List Settings.....	139
Table 14-2	Settings Alarms - List Alarms.....	140
Table 14-3	Settings ECG filter (user OPERATOR) - List Filter.....	141
Table 14-4	Settings Metronome (user OPERATOR) - List Adult.....	142
Table 14-5	Settings Metronome (user OPERATOR) - List child.....	142
Table 14-6	Settings Metronome (user OPERATOR) - List Autostart metr.....	143
Table 14-7	Settings Defibrillator (user OPERATOR) - List Audio.....	143
Table 14-8	Settings Defibrillator (user OPERATOR) - List Starting mode.....	144
Table 14-9	Settings AED mode (user OPERATOR) - List Audio AAM.....	144
Table 14-10	Settings AED mode (user OPERATOR) - List View.....	145
Table 14-11	Settings AED mode (user OPERATOR) - List Algorithm.....	145
Table 14-12	Settings AED mode (user OPERATOR) - List Algorithm.....	145
Table 14-13	Settings AED mode (user OPERATOR) - List Auto Energy.....	146
Table 14-14	Settings manual mode (user OPERATOR) - List View.....	147
Table 14-15	Settings manual mode (user OPERATOR) - List Auto Energy.....	148
Table 14-16	Settings manual mode (user OPERATOR) - List Ready-signal.....	148
Table 14-17	Settings corPatch CPR (user OPERATOR) - List Audio AAM.....	149
Table 14-18	Settings Pacer - List View.....	150
Table 14-19	Settings LAN (user OPERATOR) - List LAN in device.....	152
Table 14-20	System settings (1) (user OPERATOR) - List Language.....	153
Table 14-21	System settings (1) (user OPERATOR) - List Mains filter.....	153
Table 14-22	System settings (1) (user OPERATOR) - List Configuration.....	154
Table 14-23	System settings (1) (user OPERATOR) - List SD card.....	154
Table 14-24	System settings (2) (user OPERATOR) - List Device Start.....	155
Table 14-25	System settings (2) (user OPERATOR) - List Access codes.....	156
Table 14-26	Service entries (user OPERATOR) - List service.....	162
Table 14-27	Access codes for the user levels.....	162
Table 15-1	Checking and maintenance intervals.....	166
Table 15-2	Visual check of the corpuls1.....	168
Table 15-3	Overview of recommended disinfectants.....	173
Table 16-1	Service Events.....	179
Table 17-1	Alarms.....	191
Table 17-2	Messages.....	200
Table A-1	Technical specifications - dimensions.....	220
Table A-2	Technical Specifications - Weight.....	220
Table A-3	Technical specifications - Special specifications.....	220
Table A-4	Technical Specifications - Environmental requirements.....	221
Table A-5	Technical Specifications - Storage temperature.....	221

Table A-6	Technical Specifications - Storage period Battery.....	221
Table A-7	Technical specifications - energy management and power consumption ..	222
Table A-8	Technical Specifications - Memory capacity .....	223
Table A-9	Technical Specifications - screen .....	223
Table A-10	Technical Specifications - Volume level Alarm tones .....	223
Table A-11	Technical specifications - alarm signal.....	224
Table A-12	Technical Specifications - Alarm system delays .....	224
Table A-13	Technical Specifications - Information tones (without alarm tones).....	225
Table A-14	Technical Specifications - ECG, general .....	225
Table A-15	Technical Specifications - ECG leads .....	225
Table A-16	Technical Specifications - Heart Rate .....	226
Table A-17	Maximum duration of the ECG analysis .....	226
Table A-18	Acceleration of the ECG analysis process .....	227
Table A-19	Classification table .....	228
Table A-20	Technical specifications - Decision-making reliability of the ECG analysis programme .....	229
Table A-21	Technical Specifications - ECG with therapy electrodes .....	229
Table A-22	Technical specifications - Pulse oximetry, general (option SpO <sub>2</sub> , SpCO, SpHb, SpMet, Masimo Rainbow SET® Technology).....	230
Table A-23	Technical Specifications - Defibrillator Output.....	231
Table A-24	Technical specifications - conductive surface of therapy electrodes .....	231
Table A-25	Technical Specifications - Defibrillation and cardioversion .....	232
Table A-26	Technical Specifications - Biphasic Defibrillator .....	233
Table A-27	Technical Specifications - Energy Levels Biphasic Defibrillator.....	234
Table A-28	Technical specifications - Precision of the energy released for corPatch easy electrodes and shock paddles .....	235
Table A-29	Technical specifications - precision of the energy released for corPatch easy therapy electrodes.....	235
Table A-30	Technical Specifications - Pacer, general .....	236
Table A-31	Technical specifications - general corPatch CPR.....	237
Table A-32	Technical Specifications - Dimensions of charging brackets .....	237
Table A-33	Technical Specifications Charging brackets - Environmental requirements	238
Table A-34	Technical Specifications Charging brackets - Storage conditions.....	238
Table A-35	Technical Specifications Charging brackets - Energy Management .....	238
Table A-36	Electromagnetic emission.....	240
Table A-37	Electromagnetic interference immunity part 1 .....	241
Table A-38	Electromagnetic interference immunity part 2 .....	243
Table A-39	Electromagnetic interference immunity part 2 .....	244
Table A-40	Recommended protection distances .....	245
Table A-41	Factory Settings - Alarms .....	247
Table A-42	Factory Settings - Signals.....	248
Table A-43	Factory Settings - ECG .....	248

Table A-44	Factory Settings - Defib .....	249
Table A-45	Factory Settings - Pacer .....	250
Table A-46	Factory Settings - Oximetry .....	250
Table A-47	Factory Settings - System.....	250
Table A-48	Checklist Functional test .....	251



## 0 List of Illustrations

Figure 5-1	Interfaces at the front side of the device (illustration without pacer option) .....	18
Figure 5-2	Interfaces at the rear side of the device .....	18
Figure 5-3	Interfaces at the right hand side of the device (without corPatch CPR disposable sensor) .....	19
Figure 5-4	Interfaces at the right hand side of the device (with corPatch CPR disposable sensor) .....	20
Figure 5-5	LAN interface .....	20
Figure 5-6	Display- and operating elements (Illustration with pacer option) .....	21
Figure 5-7	Example: Alarm line after a new alarm is issued .....	24
Figure 5-8	Example: Open alarm history .....	24
Figure 6-1	Start Screen (monitoring mode) .....	27
Figure 6-2	Message before automatic shut down .....	28
Figure 6-3	Connect the magnetic clip (MagCode) to the magnetic contact field interface .....	29
Figure 6-4	Replace battery .....	30
Figure 6-5	Inserting SD card (pictured: right side of device without corPatch CPR) .....	31
Figure 6-6	Removing SD card (pictured: right side of device without corPatch CPR) .....	32
Figure 7-1	Structure of the user interface in monitoring mode .....	33
Figure 7-2	Overview main menu .....	36
Figure 7-3	Overview parameter- and curve context menu .....	37
Figure 7-4	Overview Vital parameter context menu .....	39
Figure 7-5	Overview Curve context menu .....	42
Figure 7-6	Softkey context menu QRS/PT (here: QRS/PT tone disabled) .....	44
Figure 7-7	Inverted screen .....	45
Figure 7-8	Softkey context menu view (here: View 1) .....	45
Figure 7-9	Display of Screenshot .....	46
Figure 7-10	Example: Status line/Alarm line with new alarm .....	49
Figure 7-11	Example: Alarm history .....	49
Figure 8-1	Structure of the user interface in a defibrillation mode (Example: manual mode) .....	51
Figure 8-2	Softkey Context Menu Metronome .....	53
Figure 8-3	Softkey Context Menu Synchronisation .....	54
Figure 8-4	Softkey context menu Energy .....	54
Figure 8-5	Application note corPatch CPR sensor .....	55
Figure 9-1	Structure of the user interface in pacer mode (Example: DEMAND mode) ...	57
Figure 9-2	Application note Pacer .....	59
Figure 10-1	ECG monitoring (Example: monitoring mode) .....	63
Figure 10-2	Pulse oximetry monitoring (Example: monitoring mode) .....	66

Figure 10-3	Connecting ECG electrodes (example without corPatch CPR sensor) .....	67
Figure 10-4	Connect the pulse oximetry sensor to the pulse oximetry intermediate cable.....	68
Figure 10-5	Connecting a pulse oximetry sensor (pictured: right side of device without corPatch CPR) .....	68
Figure 10-6	Connecting a pulse oximetry sensor (pictured: right side of device with corPatch CPR) .....	69
Figure 10-7	Attaching ECG electrodes to the patient.....	70
Figure 10-8	Attaching the pulse oximetry sensor (Example: finger sensor).....	71
Figure 11-1	Overview impedance indications .....	78
Figure 11-2	Overview AED Mode .....	80
Figure 11-3	Overview Manual Mode .....	83
Figure 11-4	Preparing shock paddles with baby shock electrodes.....	88
Figure 11-5	Overview Pacer mode.....	93
Figure 11-6	Selecting the metronome mode .....	97
Figure 11-7	corPatch CPR feedback information .....	98
Figure 11-8	Function corPatch CPR in manual mode (after first thorax compressions).	101
Figure 11-9	Connecting shock paddles to the therapy master cable .....	102
Figure 11-10	Connect corPatch easy electrodes or the therapy master cable.....	102
Figure 11-11	Connect the corPatch CPR intermediate cable to the corPatch CPR disposable sensor.....	103
Figure 11-12	Connecting corPatch CPR disposable sensor.....	104
Figure 11-13	Connecting the shock spoons with the Y-adapter .....	105
Figure 11-14	Connecting corPatch easy electrodes for defibrillation and cardioversion to the patient.....	106
Figure 11-15	Attaching corPatch easy electrodes to the patient.....	107
Figure 11-16	Place the shock paddles on the thorax of the patient .....	108
Figure 11-17	Attach the corPatch CPR disposable sensor .....	109
Figure 13-1	Overview User interface elements .....	112
Figure 13-2	Configuration Alarm limits (example adult).....	114
Figure 13-3	Configuration Alarm autolimits .....	117
Figure 13-4	Settings Alarms .....	117
Figure 13-5	Settings Curves.....	118
Figure 13-6	Settings Vital parameters .....	120
Figure 13-7	Settings Views .....	122
Figure 13-8	Settings ECG .....	123
Figure 13-9	Settings Metronome.....	125
Figure 13-10	Settings corPatch CPR .....	126
Figure 13-11	Settings Pulse oximetry .....	127
Figure 13-12	Information Pulse oximetry function .....	129
Figure 13-13	Select patient class/-group.....	130
Figure 13-14	Overview Patient data .....	130

Figure 13-15	Entering patient data .....	131
Figure 13-16	Mission administration.....	132
Figure 13-17	System settings (1).....	133
Figure 13-18	System settings (2).....	134
Figure 13-19	Master data .....	135
Figure 13-20	Entering master data .....	136
Figure 13-21	System information 1.....	136
Figure 13-22	System information 2 .....	137
Figure 13-23	Entering the access code.....	137
Figure 14-1	Settings Alarms (user OPERATOR) .....	139
Figure 14-2	Settings ECG filter (user OPERATOR).....	141
Figure 14-3	Settings Metronome (user OPERATOR).....	142
Figure 14-4	Settings Defibrillator (user OPERATOR).....	143
Figure 14-5	Settings AED mode (user OPERATOR).....	144
Figure 14-6	Settings manual mode (user OPERATOR) .....	147
Figure 14-7	Settings corPatch CPR (user OPERATOR) .....	149
Figure 14-8	Settings Pacer (user OPERATOR) .....	150
Figure 14-9	Settings LAN (user OPERATOR) .....	151
Figure 14-10	Entering the IP address (user OPERATOR).....	152
Figure 14-11	System settings (1) (user OPERATOR).....	153
Figure 14-12	System settings (2) (user OPERATOR).....	155
Figure 14-13	Update - Select the package to be installed (user OPERATOR) .....	156
Figure 14-14	Update - selected file (user OPERATOR) .....	157
Figure 14-15	Update - Installation progress (user OPERATOR) .....	158
Figure 14-16	Update - Successful installation (user OPERATOR).....	158
Figure 14-17	Update - Displaying current software/firmware version (user OPERATOR) .	159
Figure 14-18	Service entry (user OPERATOR only).....	161
Figure 14-19	Entering the access code.....	163
Figure 14-20	Activating the demo mode .....	164
Figure 18-1	Inserting the device into the charging bracket.....	202
Figure 18-2	Removing from the charging bracket .....	203
Figure 19-1	corpuls1 with accessory bags and front cover and shock paddle holders.	205
Figure 19-2	Fixating the accessory bags (Example left side) .....	206
Figure 19-3	Shock paddle holders on accessory bags for attaching shock paddles.....	209
Figure A-1	Biphasic shockwave - impedances of 25 Ohm to 100 Ohm.....	236
Figure A-2	Biphasic shockwave - impedances of 125 Ohm to 175 Ohm.....	236

(Page intentionally left blank)

## Index

<b>A</b>	
Accessories	
Approved accessories .....	218
AED mode	
Overview .....	79
Alarm history	
Opening .....	48
Alarms	
Alarm list .....	181
Confirming .....	50
In parameter field .....	25
Setting alarm limits for vital parameters .....	114
Setting Autolimits for vital parameters .....	116
Alarm suspension	
Disabling .....	47
Enabling .....	47
In parameter field .....	25
Alarm tone silencing function	
Enabling .....	48
Application note	
corPatch CPR sensor .....	55
Pacer .....	59
Automatic shut down .....	28
<b>B</b>	
Battery	
Charging time .....	222
<b>C</b>	
Cardioversion	
Synchronisation option .....	54
Checks and maintenance measures	
Intervals .....	166
Cleaning/disinfecting accessories	
Accessory bags and frontcover .....	176
Baby shock electrodes .....	176
Charging bracket .....	175
ECG monitoring cable .....	175
Pulse oximetry sensor .....	175
Shock paddles .....	176
Therapy master cable .....	177
Cleaning/Disinfecting accessories	
CPR intermediate cable .....	177
Consumables	
Approved accessories .....	218
corPatch CPR disposable sensor	
Connect .....	104
corPatch CPR Feedback	
corPatch CPR disposable sensor .....	98
CPR support	
with corPatch CPR disposable sensor .....	100
Curve context menu	
Changing amplitude .....	43
Changing curve .....	42
Changing sweep speed .....	43
Opening .....	41
<b>D</b>	
Defibrillation in AED mode	
With corPatch easy electrodes .....	81, 82
Defibrillation in AED Mode	
Calling up .....	78
Defibrillation in manual mode	
Calling up .....	82
With corPatch easy electrodes .....	85
With shock paddles .....	86
Defibrillation mode	
Configuring curve field/parameter field .....	146
Energy .....	54
Shock energy .....	52
Switching to monitoring mode .....	56
Device	
Alarms .....	23
Cleaning/Disinfecting .....	174
Inserting into adapter charging bracket .....	203
Inserting into charging bracket .....	202
Operating time .....	222
Reminder signal .....	25
Removing from adapter charging bracket .....	204
Removing from charging bracket .....	203
Repair and Service .....	172
Warranty .....	216
<b>E</b>	
ECG monitoring	



## T

Technical safety check .....	172
Therapy electrodes	
Attaching to patient .....	105
Connection to device.....	101
Overview.....	74

## V

View	
Configuring .....	122
Selecting .....	45
Softkey context menu .....	44
Vital parameter context menu	
Adopting autolimits.....	41
Changing vital parameter.....	39
Disabling vital parameter alarm.....	40
Enabling vital parameter alarm.....	40
Opening .....	38



GS Elektromedizinische Geräte  
G. Stemple GmbH  
Hauswiesenstraße 26  
86916 Kaufering  
Deutschland  
Telefon: +49-8191-65722-0  
Telefax: +49-8191-65722-22  
Internet: [www.corpuls.world](http://www.corpuls.world)

---